











Assembly code	Assembly revision	Assembly image
ASM2442A/0.D05	Cooking chamber	
ASM3308A/0.D02	Electrical system	
ASM2415C/0.D00	Door	
ASM2460A/0.D07	External cover	

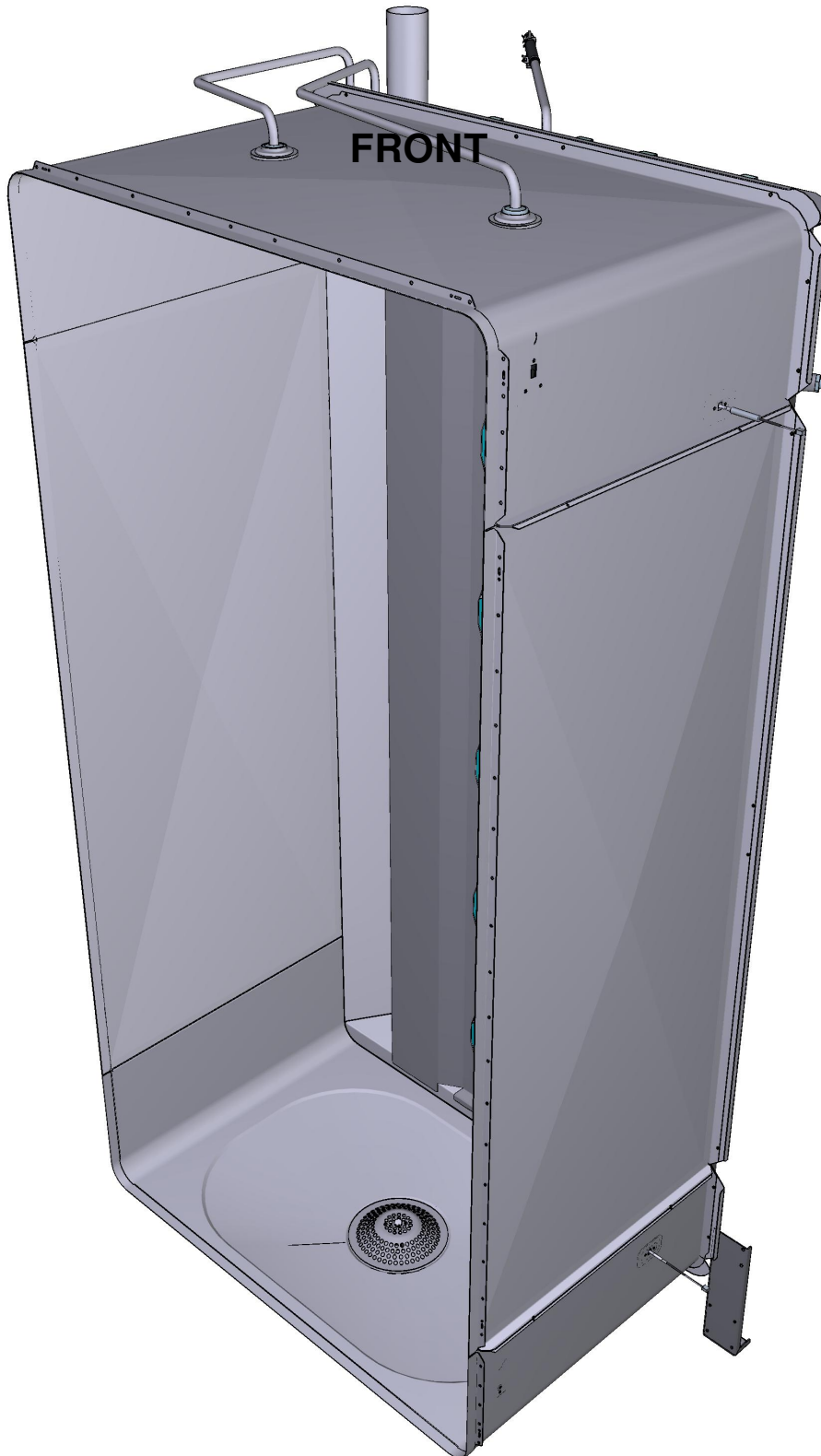

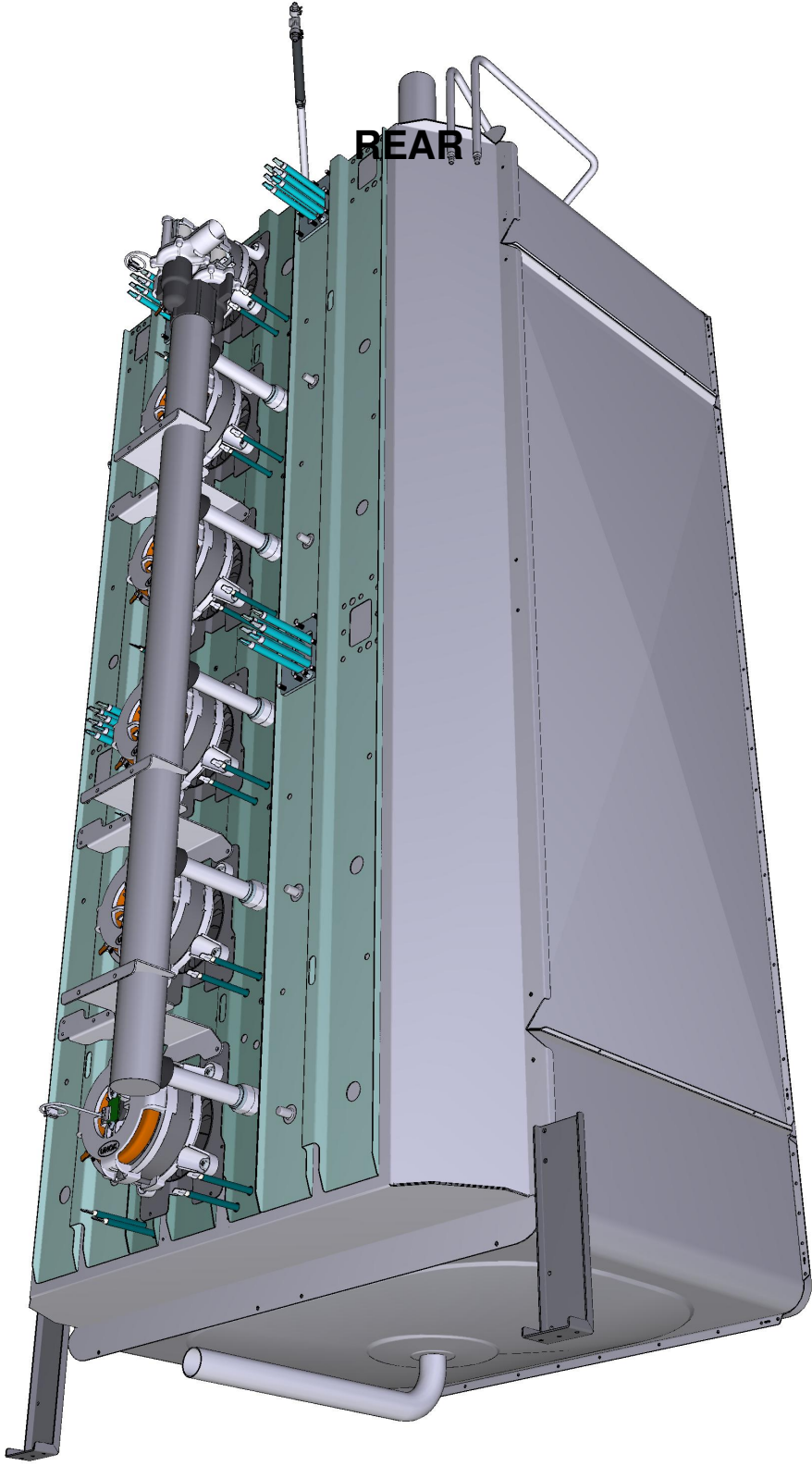
ASM2442A/0.D05 - Cooking chamber

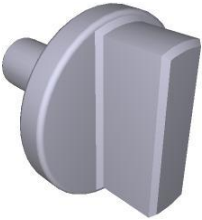

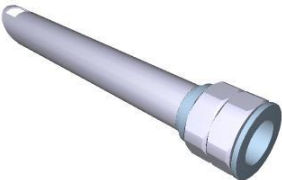

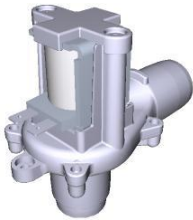

ASM2442A/0.D05 - Cooking chamber







COMPONENT			SPARE PART																														
Code	Description	Image	Code	Description	Components list																												
VM1820A	LATERAL SUPPORTS M6 FIXING BOLT		KVM1820A	THUMB SCREW 10PCS KIT	<table border="1"> <thead> <tr> <th>Code</th> <th>Description</th> <th>Qty</th> <th>UOM</th> </tr> </thead> <tbody> <tr> <td>VM1224A0</td> <td>65MY 220MM 2 COLOURS SHRINK TUBE</td> <td>0.200</td> <td>M</td> </tr> <tr> <td>VM1820A0</td> <td>LATERAL SUPPORTS M6 FIXING BOLT</td> <td>10</td> <td>PZ</td> </tr> </tbody> </table>	Code	Description	Qty	UOM	VM1224A0	65MY 220MM 2 COLOURS SHRINK TUBE	0.200	M	VM1820A0	LATERAL SUPPORTS M6 FIXING BOLT	10	PZ																
Code	Description	Qty	UOM																														
VM1224A0	65MY 220MM 2 COLOURS SHRINK TUBE	0.200	M																														
VM1820A0	LATERAL SUPPORTS M6 FIXING BOLT	10	PZ																														
VI1058A			VI1058A0																														
ASM2450A	Venturi		ASM2450A0	Venturi																													
VM1336A	M24 CH28 ST. STEEL NUT		VM1336A0	M24 CH28 ST. STEEL NUT																													
VM2377A	220 V 50/60 HZ VENTURI KIT		KVM2377A	MM 220 V VENTURI ACTUATOR SYSTEM KIT	<table border="1"> <thead> <tr> <th>Code</th> <th>Description</th> <th>Qty</th> <th>UOM</th> </tr> </thead> <tbody> <tr> <td>GN1556A0</td> <td>MM VENTURI SEAL</td> <td>1</td> <td>PZ</td> </tr> <tr> <td>MOV0016A0</td> <td>HOOD RING GASKET GN1110A2</td> <td>0.100</td> <td>PZ</td> </tr> <tr> <td>RC1378A0</td> <td>HOSE CLAMP</td> <td>3</td> <td>PZ</td> </tr> <tr> <td>TB1520A0</td> <td>INT. Ø=38 TH=4 DRAIN BLACK RUBBER PIPE</td> <td>0.170</td> <td>M</td> </tr> <tr> <td>VE1135A0</td> <td>220 V 50/60 HZ VENTURI ACTUATOR</td> <td>1</td> <td>PZ</td> </tr> <tr> <td>VI1032A0</td> <td>SCREW M4X16 TCB+ INOX</td> <td>1</td> <td>PZ</td> </tr> </tbody> </table>	Code	Description	Qty	UOM	GN1556A0	MM VENTURI SEAL	1	PZ	MOV0016A0	HOOD RING GASKET GN1110A2	0.100	PZ	RC1378A0	HOSE CLAMP	3	PZ	TB1520A0	INT. Ø=38 TH=4 DRAIN BLACK RUBBER PIPE	0.170	M	VE1135A0	220 V 50/60 HZ VENTURI ACTUATOR	1	PZ	VI1032A0	SCREW M4X16 TCB+ INOX	1	PZ
Code	Description	Qty	UOM																														
GN1556A0	MM VENTURI SEAL	1	PZ																														
MOV0016A0	HOOD RING GASKET GN1110A2	0.100	PZ																														
RC1378A0	HOSE CLAMP	3	PZ																														
TB1520A0	INT. Ø=38 TH=4 DRAIN BLACK RUBBER PIPE	0.170	M																														
VE1135A0	220 V 50/60 HZ VENTURI ACTUATOR	1	PZ																														
VI1032A0	SCREW M4X16 TCB+ INOX	1	PZ																														



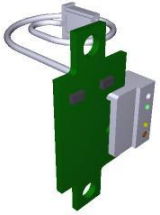

COMPONENT			SPARE PART																																																						
Code	Description	Image	Code	Description	Components list																																																				
VM2377A	220 V 50/60 HZ VENTURI KIT		KVM2377A	MM 220 V VENTURI ACTUATOR SYSTEM KIT	<table border="1"> <thead> <tr> <th>Code</th> <th>Description</th> <th>Qty</th> <th>UOM</th> </tr> </thead> <tbody> <tr> <td>VI1220A1</td> <td>4,2X12 TCB SELF-TAPPIN G SCREW</td> <td>6</td> <td>PZ</td> </tr> <tr> <td>VM2345A0</td> <td>MM VENTURI UPPER BODY</td> <td>1</td> <td>PZ</td> </tr> <tr> <td>VM2345A0</td> <td>MM VENTURI UPPER BODY</td> <td>1</td> <td>PZ</td> </tr> <tr> <td>VM2346A0</td> <td>MM VENTURI LOWER BODY</td> <td>1</td> <td>PZ</td> </tr> <tr> <td>VM2346A0</td> <td>MM VENTURI LOWER BODY</td> <td>1</td> <td>PZ</td> </tr> <tr> <td>VM2346A1</td> <td>S6 VENTURI LOWER HALF</td> <td>1</td> <td>PZ</td> </tr> <tr> <td>VM2347A0</td> <td>VENTURI MIND.MAPS COVER</td> <td>1</td> <td>PZ</td> </tr> <tr> <td>VM2347A0</td> <td>VENTURI MIND.MAPS COVER</td> <td>1</td> <td>PZ</td> </tr> <tr> <td>VM2348A0</td> <td>VENTURI PLATE SPACE</td> <td>1</td> <td>PZ</td> </tr> <tr> <td>VM2348A0</td> <td>VENTURI PLATE SPACE</td> <td>1</td> <td>PZ</td> </tr> <tr> <td>VM2349A0</td> <td>VENTURI LOWER BUSHING</td> <td>1</td> <td>PZ</td> </tr> <tr> <td>VM2349A0</td> <td>VENTURI LOWER BUSHING</td> <td>1</td> <td>PZ</td> </tr> </tbody> </table>	Code	Description	Qty	UOM	VI1220A1	4,2X12 TCB SELF-TAPPIN G SCREW	6	PZ	VM2345A0	MM VENTURI UPPER BODY	1	PZ	VM2345A0	MM VENTURI UPPER BODY	1	PZ	VM2346A0	MM VENTURI LOWER BODY	1	PZ	VM2346A0	MM VENTURI LOWER BODY	1	PZ	VM2346A1	S6 VENTURI LOWER HALF	1	PZ	VM2347A0	VENTURI MIND.MAPS COVER	1	PZ	VM2347A0	VENTURI MIND.MAPS COVER	1	PZ	VM2348A0	VENTURI PLATE SPACE	1	PZ	VM2348A0	VENTURI PLATE SPACE	1	PZ	VM2349A0	VENTURI LOWER BUSHING	1	PZ	VM2349A0	VENTURI LOWER BUSHING	1	PZ
Code	Description	Qty	UOM																																																						
VI1220A1	4,2X12 TCB SELF-TAPPIN G SCREW	6	PZ																																																						
VM2345A0	MM VENTURI UPPER BODY	1	PZ																																																						
VM2345A0	MM VENTURI UPPER BODY	1	PZ																																																						
VM2346A0	MM VENTURI LOWER BODY	1	PZ																																																						
VM2346A0	MM VENTURI LOWER BODY	1	PZ																																																						
VM2346A1	S6 VENTURI LOWER HALF	1	PZ																																																						
VM2347A0	VENTURI MIND.MAPS COVER	1	PZ																																																						
VM2347A0	VENTURI MIND.MAPS COVER	1	PZ																																																						
VM2348A0	VENTURI PLATE SPACE	1	PZ																																																						
VM2348A0	VENTURI PLATE SPACE	1	PZ																																																						
VM2349A0	VENTURI LOWER BUSHING	1	PZ																																																						
VM2349A0	VENTURI LOWER BUSHING	1	PZ																																																						
GN1670A	EPDM 1,78 CORD INT D=26,7 O-RING		KG1670A	O-RING ØINT 26,7 EPDM ROPE 1,78 2PCS KIT	<table border="1"> <thead> <tr> <th>Code</th> <th>Description</th> <th>Qty</th> <th>UOM</th> </tr> </thead> <tbody> <tr> <td>GN1670A0</td> <td>EPDM 1,78 CORD INT D=26,7 O-RING</td> <td>2</td> <td>PZ</td> </tr> </tbody> </table>	Code	Description	Qty	UOM	GN1670A0	EPDM 1,78 CORD INT D=26,7 O-RING	2	PZ																																												
Code	Description	Qty	UOM																																																						
GN1670A0	EPDM 1,78 CORD INT D=26,7 O-RING	2	PZ																																																						
VM1319A	DOUBLE VENTURI Y FITTING		KVM1319A	DOUBLE VENTURI Y CONNECTION KIT																																																					







COMPONENT			SPARE PART																														
Code	Description	Image	Code	Description	Components list																												
VM1333A	D20-D50 SEALING GASKET		KVM1333A	D20-D50 SEALING GASKET 5PCS KIT																													
TB1838A	D50 VENTURI COLLECTOR PIPE		TB1838A0	D50 VENTURI COLLECTOR PIPE																													
0H2046A	XEVL-20XX CHAMBER HOLDING BRACKET		0H2046A0	XEVL-20XX CHAMBER HOLDING BRACKET																													
VE1550A	5X3 MM NEODYMIUM MAGNET		KPE1710B	MOTOR REVOLUTIONS SENSOR KIT	<table border="1"> <thead> <tr> <th>Code</th> <th>Description</th> <th>Qty</th> <th>UOM</th> </tr> </thead> <tbody> <tr> <td>CE1119A0</td> <td>AMPMODU2 4P 4XAWG22 L1500 RAST 4P CABLE</td> <td>1</td> <td>PZ</td> </tr> <tr> <td>PE1040A0</td> <td>RAST MOTOR SENSOR</td> <td>1</td> <td>PZ</td> </tr> <tr> <td>PE1710B0</td> <td>MOTOR REVOLUTION AND DIRECTION SENSOR</td> <td>1</td> <td>PZ</td> </tr> <tr> <td>VE1550A0</td> <td>5X3 MM NEODYMIUM MAGNET</td> <td>1</td> <td>PZ</td> </tr> <tr> <td>VI1966A0</td> <td>M4X14 FLATHEAD SCREW</td> <td>1</td> <td>PZ</td> </tr> <tr> <td>VM1635A0</td> <td>MAGNET HOLDING DIS</td> <td>1</td> <td>PZ</td> </tr> </tbody> </table>	Code	Description	Qty	UOM	CE1119A0	AMPMODU2 4P 4XAWG22 L1500 RAST 4P CABLE	1	PZ	PE1040A0	RAST MOTOR SENSOR	1	PZ	PE1710B0	MOTOR REVOLUTION AND DIRECTION SENSOR	1	PZ	VE1550A0	5X3 MM NEODYMIUM MAGNET	1	PZ	VI1966A0	M4X14 FLATHEAD SCREW	1	PZ	VM1635A0	MAGNET HOLDING DIS	1	PZ
Code	Description	Qty	UOM																														
CE1119A0	AMPMODU2 4P 4XAWG22 L1500 RAST 4P CABLE	1	PZ																														
PE1040A0	RAST MOTOR SENSOR	1	PZ																														
PE1710B0	MOTOR REVOLUTION AND DIRECTION SENSOR	1	PZ																														
VE1550A0	5X3 MM NEODYMIUM MAGNET	1	PZ																														
VI1966A0	M4X14 FLATHEAD SCREW	1	PZ																														
VM1635A0	MAGNET HOLDING DIS	1	PZ																														

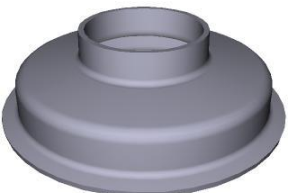

COMPONENT			SPARE PART																														
Code	Description	Image	Code	Description	Components list																												
PE1710B	MOTOR REVOLUTION AND DIRECTION SENSO		KPE1710B	MOTOR REVOLUTIONS SENSOR KIT	<table border="1"> <thead> <tr> <th>Code</th> <th>Description</th> <th>Qty</th> <th>UOM</th> </tr> </thead> <tbody> <tr> <td>CE1119A0</td> <td>AMPMODU2 4P 4XAWG22 L1500 RAST 4P CABLE</td> <td>1</td> <td>PZ</td> </tr> <tr> <td>PE1040A0</td> <td>RAST MOTOR SENSOR</td> <td>1</td> <td>PZ</td> </tr> <tr> <td>PE1710B0</td> <td>MOTOR REVOLUTION AND DIRECTION SENSOR</td> <td>1</td> <td>PZ</td> </tr> <tr> <td>VE1550A0</td> <td>5X3 MM NEODYMIUM MAGNET</td> <td>1</td> <td>PZ</td> </tr> <tr> <td>VI1966A0</td> <td>M4X14 FLATHEAD SCREW</td> <td>1</td> <td>PZ</td> </tr> <tr> <td>VM1635A0</td> <td>MAGNET HOLDING DIS</td> <td>1</td> <td>PZ</td> </tr> </tbody> </table>	Code	Description	Qty	UOM	CE1119A0	AMPMODU2 4P 4XAWG22 L1500 RAST 4P CABLE	1	PZ	PE1040A0	RAST MOTOR SENSOR	1	PZ	PE1710B0	MOTOR REVOLUTION AND DIRECTION SENSOR	1	PZ	VE1550A0	5X3 MM NEODYMIUM MAGNET	1	PZ	VI1966A0	M4X14 FLATHEAD SCREW	1	PZ	VM1635A0	MAGNET HOLDING DIS	1	PZ
Code	Description	Qty	UOM																														
CE1119A0	AMPMODU2 4P 4XAWG22 L1500 RAST 4P CABLE	1	PZ																														
PE1040A0	RAST MOTOR SENSOR	1	PZ																														
PE1710B0	MOTOR REVOLUTION AND DIRECTION SENSOR	1	PZ																														
VE1550A0	5X3 MM NEODYMIUM MAGNET	1	PZ																														
VI1966A0	M4X14 FLATHEAD SCREW	1	PZ																														
VM1635A0	MAGNET HOLDING DIS	1	PZ																														
0H2119A	DRAIN GRID		0H2119A1	DRAIN GRID																													
GN1632A	CORE PROBE INLET HOLDING GASKET		GN1632A0	CORE PROBE INLET HOLDING GASKET																													
SN1049A	L3200 PEEK MULTI.POINT CORE PROBE		KSN1049A	MULTIPOINT CORE PROBE KIT L3200	<table border="1"> <thead> <tr> <th>Code</th> <th>Description</th> <th>Qty</th> <th>UOM</th> </tr> </thead> <tbody> <tr> <td>0H8035A0</td> <td>MM CORE PROBE ACCESS COVE</td> <td>1</td> <td>PZ</td> </tr> <tr> <td>GN1632A0</td> <td>CORE PROBE INLET HOLDING GASKET</td> <td>1</td> <td>PZ</td> </tr> <tr> <td>SL1045A0</td> <td>S57 BLACK SILICONE - 80ML CARTRIDGE</td> <td>1</td> <td>PZ</td> </tr> <tr> <td>SN1049A0</td> <td></td> <td>1</td> <td>PZ</td> </tr> </tbody> </table>	Code	Description	Qty	UOM	0H8035A0	MM CORE PROBE ACCESS COVE	1	PZ	GN1632A0	CORE PROBE INLET HOLDING GASKET	1	PZ	SL1045A0	S57 BLACK SILICONE - 80ML CARTRIDGE	1	PZ	SN1049A0		1	PZ								
Code	Description	Qty	UOM																														
0H8035A0	MM CORE PROBE ACCESS COVE	1	PZ																														
GN1632A0	CORE PROBE INLET HOLDING GASKET	1	PZ																														
SL1045A0	S57 BLACK SILICONE - 80ML CARTRIDGE	1	PZ																														
SN1049A0		1	PZ																														





COMPONENT			SPARE PART														
Code	Description	Image	Code	Description	Components list												
SN1049A	L3200 PEEK MULTI.POINT CORE PROBE		KSN1049A	MULTIPOINT CORE PROBE KIT L3200	<table border="1"> <thead> <tr> <th>Code</th> <th>Description</th> <th>Qty</th> <th>UOM</th> </tr> </thead> <tbody> <tr> <td>SN1049A1</td> <td>L3200 PEEK MULTI.POINT CORE PROBE</td> <td>1</td> <td>PZ</td> </tr> <tr> <td>VI1220A1</td> <td>4,2X12 TCB SELF-TAPPIN G SCREW</td> <td>3</td> <td>PZ</td> </tr> </tbody> </table>	Code	Description	Qty	UOM	SN1049A1	L3200 PEEK MULTI.POINT CORE PROBE	1	PZ	VI1220A1	4,2X12 TCB SELF-TAPPIN G SCREW	3	PZ
Code	Description	Qty	UOM														
SN1049A1	L3200 PEEK MULTI.POINT CORE PROBE	1	PZ														
VI1220A1	4,2X12 TCB SELF-TAPPIN G SCREW	3	PZ														
TB2659A	BAFFLE CHIMNEY		KTB2659A	CORE PROBE HOLDER KIT													
0H8119A	XEVL CORE PROBE PASS-THROUGH COVER		0H8119A0	XEVL CORE PROBE PASS-THROUGH COVER													
0G1049A	XEVL-20XX-E LONG SPACER		0G1049A0	XEVL-20XX-E LONG SPACER													
0G1056A	XEVL-20XX-E FAN GUARD SPACER		0G1056A0	XEVL-20XX-E FAN GUARD SPACER													

COMPONENT			SPARE PART																						
Code	Description	Image	Code	Description	Components list																				
ASM2446A	General overview		ASM2446A0	General overview																					
VM2332A	HUMIDITY PIPES WASHER		KVM2332A	WATER PIPE BUSHING KIT VM2332A0	<table border="1"> <thead> <tr> <th>Code</th> <th>Description</th> <th>Qty</th> <th>UOM</th> </tr> </thead> <tbody> <tr> <td>VM1224A0</td> <td>65MY 220MM 2 COLOURS SHRINK TUBE</td> <td>0.200</td> <td>M</td> </tr> <tr> <td>VM2332A0</td> <td>WATER PIPE BUSHING</td> <td>1</td> <td>PZ</td> </tr> <tr> <td>VM2332A0</td> <td>WATER PIPE BUSHING</td> <td>1</td> <td>PZ</td> </tr> <tr> <td>VM2332A1</td> <td>HUMIDITY PIPES WASHE</td> <td>1</td> <td>PZ</td> </tr> </tbody> </table>	Code	Description	Qty	UOM	VM1224A0	65MY 220MM 2 COLOURS SHRINK TUBE	0.200	M	VM2332A0	WATER PIPE BUSHING	1	PZ	VM2332A0	WATER PIPE BUSHING	1	PZ	VM2332A1	HUMIDITY PIPES WASHE	1	PZ
Code	Description	Qty	UOM																						
VM1224A0	65MY 220MM 2 COLOURS SHRINK TUBE	0.200	M																						
VM2332A0	WATER PIPE BUSHING	1	PZ																						
VM2332A0	WATER PIPE BUSHING	1	PZ																						
VM2332A1	HUMIDITY PIPES WASHE	1	PZ																						
VM2571A	UPPER WATER DISTRIBUTOR		VM2571A1	UPPER WATER DISTRIBUTOR																					
VM2572A	LOWER WATER DISTRIBUTOR		VM2572A1	LOWER WATER DISTRIBUTOR																					
TB2612B	XEVL-20XX 6TH MOTOR INT WATER PIPE		K0G1059B	BIG-L GN2/1 COMPLETE FAN GUARD KIT	<table border="1"> <thead> <tr> <th>Code</th> <th>Description</th> <th>Qty</th> <th>UOM</th> </tr> </thead> <tbody> <tr> <td>0G1059B0</td> <td>XEVL-2021-EL FAN GUARD</td> <td>1</td> <td>PZ</td> </tr> <tr> <td>IP1508A1</td> <td>POLYSTYREN E U SHAPED PROFILE 2000X60X60</td> <td>1</td> <td>M</td> </tr> <tr> <td>TB2612B0</td> <td>XEVL-20XX 6TH MOTOR INT WATER PIPE</td> <td>1</td> <td>PZ</td> </tr> </tbody> </table>	Code	Description	Qty	UOM	0G1059B0	XEVL-2021-EL FAN GUARD	1	PZ	IP1508A1	POLYSTYREN E U SHAPED PROFILE 2000X60X60	1	M	TB2612B0	XEVL-20XX 6TH MOTOR INT WATER PIPE	1	PZ				
Code	Description	Qty	UOM																						
0G1059B0	XEVL-2021-EL FAN GUARD	1	PZ																						
IP1508A1	POLYSTYREN E U SHAPED PROFILE 2000X60X60	1	M																						
TB2612B0	XEVL-20XX 6TH MOTOR INT WATER PIPE	1	PZ																						

COMPONENT			SPARE PART																																														
Code	Description	Image	Code	Description	Components list																																												
TB2612B	XEVL-20XX 6TH MOTOR INT WATER PIPE		K0G1059B	BIG-L GN2/1 COMPLETE FAN GUARD KIT	<table border="1"> <thead> <tr> <th>Code</th> <th>Description</th> <th>Qty</th> <th>UOM</th> </tr> </thead> <tbody> <tr> <td>TB2614B0</td> <td>XEVL-20XX 5TH MOTOR INT WATER PIPE</td> <td>1</td> <td>PZ</td> </tr> <tr> <td>TB2616B0</td> <td>BAFFLE CHIMNEY</td> <td>1</td> <td>PZ</td> </tr> <tr> <td>TB2618B0</td> <td>BAFFLE CHIMNEY</td> <td>1</td> <td>PZ</td> </tr> <tr> <td>TB2620B0</td> <td>XEVL-20XX 2ND MOTOR INT WATER PIPE</td> <td>1</td> <td>PZ</td> </tr> <tr> <td>TB2621B0</td> <td>BAFFLE CHIMNEY</td> <td>1</td> <td>PZ</td> </tr> <tr> <td>VI1220A1</td> <td>4,2X12 TCB SELF-TAPPIN G SCREW</td> <td>11</td> <td>PZ</td> </tr> <tr> <td>VM1059A1</td> <td>HEAT SHRINK FILM H800</td> <td>1.700</td> <td>M</td> </tr> <tr> <td>VM2332A1</td> <td>HUMIDITY PIPES WASHE</td> <td>1</td> <td>PZ</td> </tr> <tr> <td>VM2571A1</td> <td>UPPER WATER DISTRIBUTOR</td> <td>5</td> <td>PZ</td> </tr> <tr> <td>VM2572A1</td> <td>LOWER WATER DISTRIBUTOR</td> <td>5</td> <td>PZ</td> </tr> </tbody> </table>	Code	Description	Qty	UOM	TB2614B0	XEVL-20XX 5TH MOTOR INT WATER PIPE	1	PZ	TB2616B0	BAFFLE CHIMNEY	1	PZ	TB2618B0	BAFFLE CHIMNEY	1	PZ	TB2620B0	XEVL-20XX 2ND MOTOR INT WATER PIPE	1	PZ	TB2621B0	BAFFLE CHIMNEY	1	PZ	VI1220A1	4,2X12 TCB SELF-TAPPIN G SCREW	11	PZ	VM1059A1	HEAT SHRINK FILM H800	1.700	M	VM2332A1	HUMIDITY PIPES WASHE	1	PZ	VM2571A1	UPPER WATER DISTRIBUTOR	5	PZ	VM2572A1	LOWER WATER DISTRIBUTOR	5	PZ
			Code	Description	Qty	UOM																																											
TB2614B0	XEVL-20XX 5TH MOTOR INT WATER PIPE	1	PZ																																														
TB2616B0	BAFFLE CHIMNEY	1	PZ																																														
TB2618B0	BAFFLE CHIMNEY	1	PZ																																														
TB2620B0	XEVL-20XX 2ND MOTOR INT WATER PIPE	1	PZ																																														
TB2621B0	BAFFLE CHIMNEY	1	PZ																																														
VI1220A1	4,2X12 TCB SELF-TAPPIN G SCREW	11	PZ																																														
VM1059A1	HEAT SHRINK FILM H800	1.700	M																																														
VM2332A1	HUMIDITY PIPES WASHE	1	PZ																																														
VM2571A1	UPPER WATER DISTRIBUTOR	5	PZ																																														
VM2572A1	LOWER WATER DISTRIBUTOR	5	PZ																																														
K0G1041B	BIG-L GN1/1 PLUS COMPLETE FAN GUARD KIT	<table border="1"> <thead> <tr> <th>Code</th> <th>Description</th> <th>Qty</th> <th>UOM</th> </tr> </thead> <tbody> <tr> <td>0G1041B0</td> <td>XEVL-2011 FAN GUARD</td> <td>1</td> <td>PZ</td> </tr> <tr> <td>IP1508A1</td> <td>POLYSTYREN E U SHAPED PROFILE 2000X60X60</td> <td>3</td> <td>M</td> </tr> <tr> <td>TB2612B0</td> <td>XEVL-20XX 6TH MOTOR INT WATER PIPE</td> <td>1</td> <td>PZ</td> </tr> <tr> <td>TB2614B0</td> <td>XEVL-20XX 5TH MOTOR INT WATER PIPE</td> <td>1</td> <td>PZ</td> </tr> <tr> <td>TB2616B0</td> <td>BAFFLE CHIMNEY</td> <td>1</td> <td>PZ</td> </tr> <tr> <td>TB2618B0</td> <td>BAFFLE CHIMNEY</td> <td>1</td> <td>PZ</td> </tr> <tr> <td>TB2620B0</td> <td>XEVL-20XX 2ND MOTOR INT WATER PIPE</td> <td>1</td> <td>PZ</td> </tr> <tr> <td>TB2621B0</td> <td>BAFFLE CHIMNEY</td> <td>1</td> <td>PZ</td> </tr> </tbody> </table>	Code	Description	Qty	UOM	0G1041B0	XEVL-2011 FAN GUARD	1	PZ	IP1508A1	POLYSTYREN E U SHAPED PROFILE 2000X60X60	3	M	TB2612B0	XEVL-20XX 6TH MOTOR INT WATER PIPE	1	PZ	TB2614B0	XEVL-20XX 5TH MOTOR INT WATER PIPE	1	PZ	TB2616B0	BAFFLE CHIMNEY	1	PZ	TB2618B0	BAFFLE CHIMNEY	1	PZ	TB2620B0	XEVL-20XX 2ND MOTOR INT WATER PIPE	1	PZ	TB2621B0	BAFFLE CHIMNEY	1	PZ											
Code	Description	Qty	UOM																																														
0G1041B0	XEVL-2011 FAN GUARD	1	PZ																																														
IP1508A1	POLYSTYREN E U SHAPED PROFILE 2000X60X60	3	M																																														
TB2612B0	XEVL-20XX 6TH MOTOR INT WATER PIPE	1	PZ																																														
TB2614B0	XEVL-20XX 5TH MOTOR INT WATER PIPE	1	PZ																																														
TB2616B0	BAFFLE CHIMNEY	1	PZ																																														
TB2618B0	BAFFLE CHIMNEY	1	PZ																																														
TB2620B0	XEVL-20XX 2ND MOTOR INT WATER PIPE	1	PZ																																														
TB2621B0	BAFFLE CHIMNEY	1	PZ																																														

COMPONENT			SPARE PART																																																										
Code	Description	Image	Code	Description	Components list																																																								
TB2612B	XEVL-20XX 6TH MOTOR INT WATER PIPE		K0G1041B	BIG-L GN1/1 PLUS COMPLETE FAN GUARD KIT	<table border="1"> <thead> <tr> <th>Code</th> <th>Description</th> <th>Qty</th> <th>UOM</th> </tr> </thead> <tbody> <tr> <td>VI1220A1</td> <td>4,2X12 TCB SELF-TAPPIN G SCREW</td> <td>11</td> <td>PZ</td> </tr> <tr> <td>VM1059A1</td> <td>HEAT SHRINK FILM H800</td> <td>1.700</td> <td>M</td> </tr> <tr> <td>VM2332A1</td> <td>HUMIDITY PIPES WASHE</td> <td>1</td> <td>PZ</td> </tr> <tr> <td>VM2571A1</td> <td>UPPER WATER DISTRIBUTOR</td> <td>5</td> <td>PZ</td> </tr> <tr> <td>VM2572A1</td> <td>LOWER WATER DISTRIBUTOR</td> <td>5</td> <td>PZ</td> </tr> </tbody> </table>	Code	Description	Qty	UOM	VI1220A1	4,2X12 TCB SELF-TAPPIN G SCREW	11	PZ	VM1059A1	HEAT SHRINK FILM H800	1.700	M	VM2332A1	HUMIDITY PIPES WASHE	1	PZ	VM2571A1	UPPER WATER DISTRIBUTOR	5	PZ	VM2572A1	LOWER WATER DISTRIBUTOR	5	PZ																																
					Code	Description	Qty	UOM																																																					
VI1220A1	4,2X12 TCB SELF-TAPPIN G SCREW	11	PZ																																																										
VM1059A1	HEAT SHRINK FILM H800	1.700	M																																																										
VM2332A1	HUMIDITY PIPES WASHE	1	PZ																																																										
VM2571A1	UPPER WATER DISTRIBUTOR	5	PZ																																																										
VM2572A1	LOWER WATER DISTRIBUTOR	5	PZ																																																										
TB2614B	XEVL-20XX 5TH MOTOR INT WATER PIPE		K0G1059B	BIG-L GN2/1 COMPLETE FAN GUARD KIT	<table border="1"> <thead> <tr> <th>Code</th> <th>Description</th> <th>Qty</th> <th>UOM</th> </tr> </thead> <tbody> <tr> <td>0G1059B0</td> <td>XEVL-2021-EL FAN GUARD</td> <td>1</td> <td>PZ</td> </tr> <tr> <td>IP1508A1</td> <td>POLYSTYREN E U SHAPED PROFILE 2000X60X60</td> <td>1</td> <td>M</td> </tr> <tr> <td>TB2612B0</td> <td>XEVL-20XX 6TH MOTOR INT WATER PIPE</td> <td>1</td> <td>PZ</td> </tr> <tr> <td>TB2614B0</td> <td>XEVL-20XX 5TH MOTOR INT WATER PIPE</td> <td>1</td> <td>PZ</td> </tr> <tr> <td>TB2616B0</td> <td>BAFFLE CHIMNEY</td> <td>1</td> <td>PZ</td> </tr> <tr> <td>TB2618B0</td> <td>BAFFLE CHIMNEY</td> <td>1</td> <td>PZ</td> </tr> <tr> <td>TB2620B0</td> <td>XEVL-20XX 2ND MOTOR INT WATER PIPE</td> <td>1</td> <td>PZ</td> </tr> <tr> <td>TB2621B0</td> <td>BAFFLE CHIMNEY</td> <td>1</td> <td>PZ</td> </tr> <tr> <td>VI1220A1</td> <td>4,2X12 TCB SELF-TAPPIN G SCREW</td> <td>11</td> <td>PZ</td> </tr> <tr> <td>VM1059A1</td> <td>HEAT SHRINK FILM H800</td> <td>1.700</td> <td>M</td> </tr> <tr> <td>VM2332A1</td> <td>HUMIDITY PIPES WASHE</td> <td>1</td> <td>PZ</td> </tr> <tr> <td>VM2571A1</td> <td>UPPER WATER DISTRIBUTOR</td> <td>5</td> <td>PZ</td> </tr> <tr> <td>VM2572A1</td> <td>LOWER WATER DISTRIBUTOR</td> <td>5</td> <td>PZ</td> </tr> </tbody> </table>	Code	Description	Qty	UOM	0G1059B0	XEVL-2021-EL FAN GUARD	1	PZ	IP1508A1	POLYSTYREN E U SHAPED PROFILE 2000X60X60	1	M	TB2612B0	XEVL-20XX 6TH MOTOR INT WATER PIPE	1	PZ	TB2614B0	XEVL-20XX 5TH MOTOR INT WATER PIPE	1	PZ	TB2616B0	BAFFLE CHIMNEY	1	PZ	TB2618B0	BAFFLE CHIMNEY	1	PZ	TB2620B0	XEVL-20XX 2ND MOTOR INT WATER PIPE	1	PZ	TB2621B0	BAFFLE CHIMNEY	1	PZ	VI1220A1	4,2X12 TCB SELF-TAPPIN G SCREW	11	PZ	VM1059A1	HEAT SHRINK FILM H800	1.700	M	VM2332A1	HUMIDITY PIPES WASHE	1	PZ	VM2571A1	UPPER WATER DISTRIBUTOR	5	PZ	VM2572A1	LOWER WATER DISTRIBUTOR	5	PZ
					Code	Description	Qty	UOM																																																					
0G1059B0	XEVL-2021-EL FAN GUARD	1	PZ																																																										
IP1508A1	POLYSTYREN E U SHAPED PROFILE 2000X60X60	1	M																																																										
TB2612B0	XEVL-20XX 6TH MOTOR INT WATER PIPE	1	PZ																																																										
TB2614B0	XEVL-20XX 5TH MOTOR INT WATER PIPE	1	PZ																																																										
TB2616B0	BAFFLE CHIMNEY	1	PZ																																																										
TB2618B0	BAFFLE CHIMNEY	1	PZ																																																										
TB2620B0	XEVL-20XX 2ND MOTOR INT WATER PIPE	1	PZ																																																										
TB2621B0	BAFFLE CHIMNEY	1	PZ																																																										
VI1220A1	4,2X12 TCB SELF-TAPPIN G SCREW	11	PZ																																																										
VM1059A1	HEAT SHRINK FILM H800	1.700	M																																																										
VM2332A1	HUMIDITY PIPES WASHE	1	PZ																																																										
VM2571A1	UPPER WATER DISTRIBUTOR	5	PZ																																																										
VM2572A1	LOWER WATER DISTRIBUTOR	5	PZ																																																										







COMPONENT			SPARE PART																																																										
Code	Description	Image	Code	Description	Components list																																																								
TB2614B	XEVL-20XX 5TH MOTOR INT WATER PIPE		K0G1041B	BIG-L GN1/1 PLUS COMPLETE FAN GUARD KIT	<table border="1"> <thead> <tr> <th>Code</th> <th>Description</th> <th>Qty</th> <th>UOM</th> </tr> </thead> <tbody> <tr> <td>0G1041B0</td> <td>XEVL-2011 FAN GUARD</td> <td>1</td> <td>PZ</td> </tr> <tr> <td>IP1508A1</td> <td>POLYSTYREN E U SHAPED PROFILE 2000X60X60</td> <td>3</td> <td>M</td> </tr> <tr> <td>TB2612B0</td> <td>XEVL-20XX 6TH MOTOR INT WATER PIPE</td> <td>1</td> <td>PZ</td> </tr> <tr> <td>TB2614B0</td> <td>XEVL-20XX 5TH MOTOR INT WATER PIPE</td> <td>1</td> <td>PZ</td> </tr> <tr> <td>TB2616B0</td> <td>BAFFLE CHIMNEY</td> <td>1</td> <td>PZ</td> </tr> <tr> <td>TB2618B0</td> <td>BAFFLE CHIMNEY</td> <td>1</td> <td>PZ</td> </tr> <tr> <td>TB2620B0</td> <td>XEVL-20XX 2ND MOTOR INT WATER PIPE</td> <td>1</td> <td>PZ</td> </tr> <tr> <td>TB2621B0</td> <td>BAFFLE CHIMNEY</td> <td>1</td> <td>PZ</td> </tr> <tr> <td>VI1220A1</td> <td>4,2X12 TCB SELF-TAPPIN G SCREW</td> <td>11</td> <td>PZ</td> </tr> <tr> <td>VM1059A1</td> <td>HEAT SHRINK FILM H800</td> <td>1.700</td> <td>M</td> </tr> <tr> <td>VM2332A1</td> <td>HUMIDITY PIPES WASHE</td> <td>1</td> <td>PZ</td> </tr> <tr> <td>VM2571A1</td> <td>UPPER WATER DISTRIBUTOR</td> <td>5</td> <td>PZ</td> </tr> <tr> <td>VM2572A1</td> <td>LOWER WATER DISTRIBUTOR</td> <td>5</td> <td>PZ</td> </tr> </tbody> </table>	Code	Description	Qty	UOM	0G1041B0	XEVL-2011 FAN GUARD	1	PZ	IP1508A1	POLYSTYREN E U SHAPED PROFILE 2000X60X60	3	M	TB2612B0	XEVL-20XX 6TH MOTOR INT WATER PIPE	1	PZ	TB2614B0	XEVL-20XX 5TH MOTOR INT WATER PIPE	1	PZ	TB2616B0	BAFFLE CHIMNEY	1	PZ	TB2618B0	BAFFLE CHIMNEY	1	PZ	TB2620B0	XEVL-20XX 2ND MOTOR INT WATER PIPE	1	PZ	TB2621B0	BAFFLE CHIMNEY	1	PZ	VI1220A1	4,2X12 TCB SELF-TAPPIN G SCREW	11	PZ	VM1059A1	HEAT SHRINK FILM H800	1.700	M	VM2332A1	HUMIDITY PIPES WASHE	1	PZ	VM2571A1	UPPER WATER DISTRIBUTOR	5	PZ	VM2572A1	LOWER WATER DISTRIBUTOR	5	PZ
					Code	Description	Qty	UOM																																																					
					0G1041B0	XEVL-2011 FAN GUARD	1	PZ																																																					
					IP1508A1	POLYSTYREN E U SHAPED PROFILE 2000X60X60	3	M																																																					
					TB2612B0	XEVL-20XX 6TH MOTOR INT WATER PIPE	1	PZ																																																					
					TB2614B0	XEVL-20XX 5TH MOTOR INT WATER PIPE	1	PZ																																																					
					TB2616B0	BAFFLE CHIMNEY	1	PZ																																																					
					TB2618B0	BAFFLE CHIMNEY	1	PZ																																																					
					TB2620B0	XEVL-20XX 2ND MOTOR INT WATER PIPE	1	PZ																																																					
					TB2621B0	BAFFLE CHIMNEY	1	PZ																																																					
					VI1220A1	4,2X12 TCB SELF-TAPPIN G SCREW	11	PZ																																																					
					VM1059A1	HEAT SHRINK FILM H800	1.700	M																																																					
					VM2332A1	HUMIDITY PIPES WASHE	1	PZ																																																					
					VM2571A1	UPPER WATER DISTRIBUTOR	5	PZ																																																					
VM2572A1	LOWER WATER DISTRIBUTOR	5	PZ																																																										
TB2616B	BAFFLE CHIMNEY		K0G1059B	BIG-L GN2/1 COMPLETE FAN GUARD KIT	<table border="1"> <thead> <tr> <th>Code</th> <th>Description</th> <th>Qty</th> <th>UOM</th> </tr> </thead> <tbody> <tr> <td>0G1059B0</td> <td>XEVL-2021-EL FAN GUARD</td> <td>1</td> <td>PZ</td> </tr> <tr> <td>IP1508A1</td> <td>POLYSTYREN E U SHAPED PROFILE 2000X60X60</td> <td>1</td> <td>M</td> </tr> <tr> <td>TB2612B0</td> <td>XEVL-20XX 6TH MOTOR INT WATER PIPE</td> <td>1</td> <td>PZ</td> </tr> <tr> <td>TB2614B0</td> <td>XEVL-20XX 5TH MOTOR INT WATER PIPE</td> <td>1</td> <td>PZ</td> </tr> <tr> <td>TB2616B0</td> <td>BAFFLE CHIMNEY</td> <td>1</td> <td>PZ</td> </tr> </tbody> </table>	Code	Description	Qty	UOM	0G1059B0	XEVL-2021-EL FAN GUARD	1	PZ	IP1508A1	POLYSTYREN E U SHAPED PROFILE 2000X60X60	1	M	TB2612B0	XEVL-20XX 6TH MOTOR INT WATER PIPE	1	PZ	TB2614B0	XEVL-20XX 5TH MOTOR INT WATER PIPE	1	PZ	TB2616B0	BAFFLE CHIMNEY	1	PZ																																
					Code	Description	Qty	UOM																																																					
					0G1059B0	XEVL-2021-EL FAN GUARD	1	PZ																																																					
					IP1508A1	POLYSTYREN E U SHAPED PROFILE 2000X60X60	1	M																																																					
					TB2612B0	XEVL-20XX 6TH MOTOR INT WATER PIPE	1	PZ																																																					
TB2614B0	XEVL-20XX 5TH MOTOR INT WATER PIPE	1	PZ																																																										
TB2616B0	BAFFLE CHIMNEY	1	PZ																																																										





COMPONENT			SPARE PART																																															
Code	Description	Image	Code	Description	Components list																																													
TB2616B	BAFFLE CHIMNEY		K0G1059B	BIG-L GN2/1 COMPLETE FAN GUARD KIT	<table border="1"> <thead> <tr> <th>Code</th> <th>Description</th> <th>Qty</th> <th>UOM</th> </tr> </thead> <tbody> <tr> <td>TB2618B0</td> <td>BAFFLE CHIMNEY</td> <td>1</td> <td>PZ</td> </tr> <tr> <td>TB2620B0</td> <td>XEVL-20XX 2ND MOTOR INT WATER PIPE</td> <td>1</td> <td>PZ</td> </tr> <tr> <td>TB2621B0</td> <td>BAFFLE CHIMNEY</td> <td>1</td> <td>PZ</td> </tr> <tr> <td>VI1220A1</td> <td>4,2X12 TCB SELF-TAPPIN G SCREW</td> <td>11</td> <td>PZ</td> </tr> <tr> <td>VM1059A1</td> <td>HEAT SHRINK FILM H800</td> <td>1.700</td> <td>M</td> </tr> <tr> <td>VM2332A1</td> <td>HUMIDITY PIPES WASHE</td> <td>1</td> <td>PZ</td> </tr> <tr> <td>VM2571A1</td> <td>UPPER WATER DISTRIBUTOR</td> <td>5</td> <td>PZ</td> </tr> <tr> <td>VM2572A1</td> <td>LOWER WATER DISTRIBUTOR</td> <td>5</td> <td>PZ</td> </tr> </tbody> </table>	Code	Description	Qty	UOM	TB2618B0	BAFFLE CHIMNEY	1	PZ	TB2620B0	XEVL-20XX 2ND MOTOR INT WATER PIPE	1	PZ	TB2621B0	BAFFLE CHIMNEY	1	PZ	VI1220A1	4,2X12 TCB SELF-TAPPIN G SCREW	11	PZ	VM1059A1	HEAT SHRINK FILM H800	1.700	M	VM2332A1	HUMIDITY PIPES WASHE	1	PZ	VM2571A1	UPPER WATER DISTRIBUTOR	5	PZ	VM2572A1	LOWER WATER DISTRIBUTOR	5	PZ									
			Code	Description	Qty	UOM																																												
TB2618B0	BAFFLE CHIMNEY	1	PZ																																															
TB2620B0	XEVL-20XX 2ND MOTOR INT WATER PIPE	1	PZ																																															
TB2621B0	BAFFLE CHIMNEY	1	PZ																																															
VI1220A1	4,2X12 TCB SELF-TAPPIN G SCREW	11	PZ																																															
VM1059A1	HEAT SHRINK FILM H800	1.700	M																																															
VM2332A1	HUMIDITY PIPES WASHE	1	PZ																																															
VM2571A1	UPPER WATER DISTRIBUTOR	5	PZ																																															
VM2572A1	LOWER WATER DISTRIBUTOR	5	PZ																																															
K0G1041B	BIG-L GN1/1 PLUS COMPLETE FAN GUARD KIT	<table border="1"> <thead> <tr> <th>Code</th> <th>Description</th> <th>Qty</th> <th>UOM</th> </tr> </thead> <tbody> <tr> <td>0G1041B0</td> <td>XEVL-2011 FAN GUARD</td> <td>1</td> <td>PZ</td> </tr> <tr> <td>IP1508A1</td> <td>POLYSTYREN E U SHAPED PROFILE 2000X60X60</td> <td>3</td> <td>M</td> </tr> <tr> <td>TB2612B0</td> <td>XEVL-20XX 6TH MOTOR INT WATER PIPE</td> <td>1</td> <td>PZ</td> </tr> <tr> <td>TB2614B0</td> <td>XEVL-20XX 5TH MOTOR INT WATER PIPE</td> <td>1</td> <td>PZ</td> </tr> <tr> <td>TB2616B0</td> <td>BAFFLE CHIMNEY</td> <td>1</td> <td>PZ</td> </tr> <tr> <td>TB2618B0</td> <td>BAFFLE CHIMNEY</td> <td>1</td> <td>PZ</td> </tr> <tr> <td>TB2620B0</td> <td>XEVL-20XX 2ND MOTOR INT WATER PIPE</td> <td>1</td> <td>PZ</td> </tr> <tr> <td>TB2621B0</td> <td>BAFFLE CHIMNEY</td> <td>1</td> <td>PZ</td> </tr> <tr> <td>VI1220A1</td> <td>4,2X12 TCB SELF-TAPPIN G SCREW</td> <td>11</td> <td>PZ</td> </tr> <tr> <td>VM1059A1</td> <td>HEAT SHRINK FILM H800</td> <td>1.700</td> <td>M</td> </tr> <tr> <td>VM2332A1</td> <td>HUMIDITY PIPES WASHE</td> <td>1</td> <td>PZ</td> </tr> </tbody> </table>	Code	Description	Qty	UOM	0G1041B0	XEVL-2011 FAN GUARD	1	PZ	IP1508A1	POLYSTYREN E U SHAPED PROFILE 2000X60X60	3	M	TB2612B0	XEVL-20XX 6TH MOTOR INT WATER PIPE	1	PZ	TB2614B0	XEVL-20XX 5TH MOTOR INT WATER PIPE	1	PZ	TB2616B0	BAFFLE CHIMNEY	1	PZ	TB2618B0	BAFFLE CHIMNEY	1	PZ	TB2620B0	XEVL-20XX 2ND MOTOR INT WATER PIPE	1	PZ	TB2621B0	BAFFLE CHIMNEY	1	PZ	VI1220A1	4,2X12 TCB SELF-TAPPIN G SCREW	11	PZ	VM1059A1	HEAT SHRINK FILM H800	1.700	M	VM2332A1	HUMIDITY PIPES WASHE	1	PZ
Code	Description	Qty	UOM																																															
0G1041B0	XEVL-2011 FAN GUARD	1	PZ																																															
IP1508A1	POLYSTYREN E U SHAPED PROFILE 2000X60X60	3	M																																															
TB2612B0	XEVL-20XX 6TH MOTOR INT WATER PIPE	1	PZ																																															
TB2614B0	XEVL-20XX 5TH MOTOR INT WATER PIPE	1	PZ																																															
TB2616B0	BAFFLE CHIMNEY	1	PZ																																															
TB2618B0	BAFFLE CHIMNEY	1	PZ																																															
TB2620B0	XEVL-20XX 2ND MOTOR INT WATER PIPE	1	PZ																																															
TB2621B0	BAFFLE CHIMNEY	1	PZ																																															
VI1220A1	4,2X12 TCB SELF-TAPPIN G SCREW	11	PZ																																															
VM1059A1	HEAT SHRINK FILM H800	1.700	M																																															
VM2332A1	HUMIDITY PIPES WASHE	1	PZ																																															









COMPONENT			SPARE PART																																																																									
Code	Description	Image	Code	Description	Components list																																																																							
TB2616B	BAFFLE CHIMNEY		K0G1041B	BIG-L GN1/1 PLUS COMPLETE FAN GUARD KIT	<table border="1"> <thead> <tr> <th>Code</th> <th>Description</th> <th>Qty</th> <th>UOM</th> </tr> </thead> <tbody> <tr> <td>VM2571A1</td> <td>UPPER WATER DISTRIBUTOR</td> <td>5</td> <td>PZ</td> </tr> <tr> <td>VM2572A1</td> <td>LOWER WATER DISTRIBUTOR</td> <td>5</td> <td>PZ</td> </tr> </tbody> </table>	Code	Description	Qty	UOM	VM2571A1	UPPER WATER DISTRIBUTOR	5	PZ	VM2572A1	LOWER WATER DISTRIBUTOR	5	PZ																																																											
Code	Description	Qty	UOM																																																																									
VM2571A1	UPPER WATER DISTRIBUTOR	5	PZ																																																																									
VM2572A1	LOWER WATER DISTRIBUTOR	5	PZ																																																																									
TB2618B	BAFFLE CHIMNEY		K0G1059B	BIG-L GN2/1 COMPLETE FAN GUARD KIT	<table border="1"> <thead> <tr> <th>Code</th> <th>Description</th> <th>Qty</th> <th>UOM</th> </tr> </thead> <tbody> <tr> <td>0G1059B0</td> <td>XEVL-2021-EL FAN GUARD</td> <td>1</td> <td>PZ</td> </tr> <tr> <td>IP1508A1</td> <td>POLYSTYREN E U SHAPED PROFILE 2000X60X60</td> <td>1</td> <td>M</td> </tr> <tr> <td>TB2612B0</td> <td>XEVL-20XX 6TH MOTOR INT WATER PIPE</td> <td>1</td> <td>PZ</td> </tr> <tr> <td>TB2614B0</td> <td>XEVL-20XX 5TH MOTOR INT WATER PIPE</td> <td>1</td> <td>PZ</td> </tr> <tr> <td>TB2616B0</td> <td>BAFFLE CHIMNEY</td> <td>1</td> <td>PZ</td> </tr> <tr> <td>TB2618B0</td> <td>BAFFLE CHIMNEY</td> <td>1</td> <td>PZ</td> </tr> <tr> <td>TB2620B0</td> <td>XEVL-20XX 2ND MOTOR INT WATER PIPE</td> <td>1</td> <td>PZ</td> </tr> <tr> <td>TB2621B0</td> <td>BAFFLE CHIMNEY</td> <td>1</td> <td>PZ</td> </tr> <tr> <td>VI1220A1</td> <td>4,2X12 TCB SELF-TAPPING SCREW</td> <td>11</td> <td>PZ</td> </tr> <tr> <td>VM1059A1</td> <td>HEAT SHRINK FILM H800</td> <td>1.700</td> <td>M</td> </tr> <tr> <td>VM2332A1</td> <td>HUMIDITY PIPES WASHE</td> <td>1</td> <td>PZ</td> </tr> <tr> <td>VM2571A1</td> <td>UPPER WATER DISTRIBUTOR</td> <td>5</td> <td>PZ</td> </tr> <tr> <td>VM2572A1</td> <td>LOWER WATER DISTRIBUTOR</td> <td>5</td> <td>PZ</td> </tr> </tbody> </table>	Code	Description	Qty	UOM	0G1059B0	XEVL-2021-EL FAN GUARD	1	PZ	IP1508A1	POLYSTYREN E U SHAPED PROFILE 2000X60X60	1	M	TB2612B0	XEVL-20XX 6TH MOTOR INT WATER PIPE	1	PZ	TB2614B0	XEVL-20XX 5TH MOTOR INT WATER PIPE	1	PZ	TB2616B0	BAFFLE CHIMNEY	1	PZ	TB2618B0	BAFFLE CHIMNEY	1	PZ	TB2620B0	XEVL-20XX 2ND MOTOR INT WATER PIPE	1	PZ	TB2621B0	BAFFLE CHIMNEY	1	PZ	VI1220A1	4,2X12 TCB SELF-TAPPING SCREW	11	PZ	VM1059A1	HEAT SHRINK FILM H800	1.700	M	VM2332A1	HUMIDITY PIPES WASHE	1	PZ	VM2571A1	UPPER WATER DISTRIBUTOR	5	PZ	VM2572A1	LOWER WATER DISTRIBUTOR	5	PZ	K0G1041B	BIG-L GN1/1 PLUS COMPLETE FAN GUARD KIT	<table border="1"> <thead> <tr> <th>Code</th> <th>Description</th> <th>Qty</th> <th>UOM</th> </tr> </thead> <tbody> <tr> <td>0G1041B0</td> <td>XEVL-2011 FAN GUARD</td> <td>1</td> <td>PZ</td> </tr> <tr> <td>IP1508A1</td> <td>POLYSTYREN E U SHAPED PROFILE 2000X60X60</td> <td>3</td> <td>M</td> </tr> </tbody> </table>	Code	Description	Qty	UOM	0G1041B0	XEVL-2011 FAN GUARD	1	PZ	IP1508A1	POLYSTYREN E U SHAPED PROFILE 2000X60X60	3	M
Code	Description	Qty	UOM																																																																									
0G1059B0	XEVL-2021-EL FAN GUARD	1	PZ																																																																									
IP1508A1	POLYSTYREN E U SHAPED PROFILE 2000X60X60	1	M																																																																									
TB2612B0	XEVL-20XX 6TH MOTOR INT WATER PIPE	1	PZ																																																																									
TB2614B0	XEVL-20XX 5TH MOTOR INT WATER PIPE	1	PZ																																																																									
TB2616B0	BAFFLE CHIMNEY	1	PZ																																																																									
TB2618B0	BAFFLE CHIMNEY	1	PZ																																																																									
TB2620B0	XEVL-20XX 2ND MOTOR INT WATER PIPE	1	PZ																																																																									
TB2621B0	BAFFLE CHIMNEY	1	PZ																																																																									
VI1220A1	4,2X12 TCB SELF-TAPPING SCREW	11	PZ																																																																									
VM1059A1	HEAT SHRINK FILM H800	1.700	M																																																																									
VM2332A1	HUMIDITY PIPES WASHE	1	PZ																																																																									
VM2571A1	UPPER WATER DISTRIBUTOR	5	PZ																																																																									
VM2572A1	LOWER WATER DISTRIBUTOR	5	PZ																																																																									
Code	Description	Qty	UOM																																																																									
0G1041B0	XEVL-2011 FAN GUARD	1	PZ																																																																									
IP1508A1	POLYSTYREN E U SHAPED PROFILE 2000X60X60	3	M																																																																									



COMPONENT			SPARE PART																																																		
Code	Description	Image	Code	Description	Components list																																																
TB2618B	BAFFLE CHIMNEY		K0G1041B	BIG-L GN1/1 PLUS COMPLETE FAN GUARD KIT	<table border="1"> <thead> <tr> <th>Code</th> <th>Description</th> <th>Qty</th> <th>UOM</th> </tr> </thead> <tbody> <tr> <td>TB2612B0</td> <td>XEVL-20XX 6TH MOTOR INT WATER PIPE</td> <td>1</td> <td>PZ</td> </tr> <tr> <td>TB2614B0</td> <td>XEVL-20XX 5TH MOTOR INT WATER PIPE</td> <td>1</td> <td>PZ</td> </tr> <tr> <td>TB2616B0</td> <td>BAFFLE CHIMNEY</td> <td>1</td> <td>PZ</td> </tr> <tr> <td>TB2618B0</td> <td>BAFFLE CHIMNEY</td> <td>1</td> <td>PZ</td> </tr> <tr> <td>TB2620B0</td> <td>XEVL-20XX 2ND MOTOR INT WATER PIPE</td> <td>1</td> <td>PZ</td> </tr> <tr> <td>TB2621B0</td> <td>BAFFLE CHIMNEY</td> <td>1</td> <td>PZ</td> </tr> <tr> <td>V11220A1</td> <td>4,2X12 TCB SELF-TAPPIN G SCREW</td> <td>11</td> <td>PZ</td> </tr> <tr> <td>VM1059A1</td> <td>HEAT SHRINK FILM H800</td> <td>1.700</td> <td>M</td> </tr> <tr> <td>VM2332A1</td> <td>HUMIDITY PIPES WASHE</td> <td>1</td> <td>PZ</td> </tr> <tr> <td>VM2571A1</td> <td>UPPER WATER DISTRIBUTOR</td> <td>5</td> <td>PZ</td> </tr> <tr> <td>VM2572A1</td> <td>LOWER WATER DISTRIBUTOR</td> <td>5</td> <td>PZ</td> </tr> </tbody> </table>	Code	Description	Qty	UOM	TB2612B0	XEVL-20XX 6TH MOTOR INT WATER PIPE	1	PZ	TB2614B0	XEVL-20XX 5TH MOTOR INT WATER PIPE	1	PZ	TB2616B0	BAFFLE CHIMNEY	1	PZ	TB2618B0	BAFFLE CHIMNEY	1	PZ	TB2620B0	XEVL-20XX 2ND MOTOR INT WATER PIPE	1	PZ	TB2621B0	BAFFLE CHIMNEY	1	PZ	V11220A1	4,2X12 TCB SELF-TAPPIN G SCREW	11	PZ	VM1059A1	HEAT SHRINK FILM H800	1.700	M	VM2332A1	HUMIDITY PIPES WASHE	1	PZ	VM2571A1	UPPER WATER DISTRIBUTOR	5	PZ	VM2572A1	LOWER WATER DISTRIBUTOR	5	PZ
					Code	Description	Qty	UOM																																													
					TB2612B0	XEVL-20XX 6TH MOTOR INT WATER PIPE	1	PZ																																													
					TB2614B0	XEVL-20XX 5TH MOTOR INT WATER PIPE	1	PZ																																													
					TB2616B0	BAFFLE CHIMNEY	1	PZ																																													
					TB2618B0	BAFFLE CHIMNEY	1	PZ																																													
					TB2620B0	XEVL-20XX 2ND MOTOR INT WATER PIPE	1	PZ																																													
					TB2621B0	BAFFLE CHIMNEY	1	PZ																																													
					V11220A1	4,2X12 TCB SELF-TAPPIN G SCREW	11	PZ																																													
					VM1059A1	HEAT SHRINK FILM H800	1.700	M																																													
					VM2332A1	HUMIDITY PIPES WASHE	1	PZ																																													
					VM2571A1	UPPER WATER DISTRIBUTOR	5	PZ																																													
					VM2572A1	LOWER WATER DISTRIBUTOR	5	PZ																																													
TB2620B	XEVL-20XX 2ND MOTOR INT WATER PIPE		K0G1059B	BIG-L GN2/1 COMPLETE FAN GUARD KIT	<table border="1"> <thead> <tr> <th>Code</th> <th>Description</th> <th>Qty</th> <th>UOM</th> </tr> </thead> <tbody> <tr> <td>0G1059B0</td> <td>XEVL-2021-EL FAN GUARD</td> <td>1</td> <td>PZ</td> </tr> <tr> <td>IP1508A1</td> <td>POLYSTYREN E U SHAPED PROFILE 2000X60X60</td> <td>1</td> <td>M</td> </tr> <tr> <td>TB2612B0</td> <td>XEVL-20XX 6TH MOTOR INT WATER PIPE</td> <td>1</td> <td>PZ</td> </tr> <tr> <td>TB2614B0</td> <td>XEVL-20XX 5TH MOTOR INT WATER PIPE</td> <td>1</td> <td>PZ</td> </tr> <tr> <td>TB2616B0</td> <td>BAFFLE CHIMNEY</td> <td>1</td> <td>PZ</td> </tr> <tr> <td>TB2618B0</td> <td>BAFFLE CHIMNEY</td> <td>1</td> <td>PZ</td> </tr> <tr> <td>TB2620B0</td> <td>XEVL-20XX 2ND MOTOR INT WATER PIPE</td> <td>1</td> <td>PZ</td> </tr> </tbody> </table>	Code	Description	Qty	UOM	0G1059B0	XEVL-2021-EL FAN GUARD	1	PZ	IP1508A1	POLYSTYREN E U SHAPED PROFILE 2000X60X60	1	M	TB2612B0	XEVL-20XX 6TH MOTOR INT WATER PIPE	1	PZ	TB2614B0	XEVL-20XX 5TH MOTOR INT WATER PIPE	1	PZ	TB2616B0	BAFFLE CHIMNEY	1	PZ	TB2618B0	BAFFLE CHIMNEY	1	PZ	TB2620B0	XEVL-20XX 2ND MOTOR INT WATER PIPE	1	PZ																
					Code	Description	Qty	UOM																																													
					0G1059B0	XEVL-2021-EL FAN GUARD	1	PZ																																													
					IP1508A1	POLYSTYREN E U SHAPED PROFILE 2000X60X60	1	M																																													
					TB2612B0	XEVL-20XX 6TH MOTOR INT WATER PIPE	1	PZ																																													
					TB2614B0	XEVL-20XX 5TH MOTOR INT WATER PIPE	1	PZ																																													
					TB2616B0	BAFFLE CHIMNEY	1	PZ																																													
					TB2618B0	BAFFLE CHIMNEY	1	PZ																																													
					TB2620B0	XEVL-20XX 2ND MOTOR INT WATER PIPE	1	PZ																																													



COMPONENT			SPARE PART																																																							
Code	Description	Image	Code	Description	Components list																																																					
TB2620B	XEVL-20XX 2ND MOTOR INT WATER PIPE		K0G1059B	BIG-L GN2/1 COMPLETE FAN GUARD KIT	<table border="1"> <thead> <tr> <th>Code</th> <th>Description</th> <th>Qty</th> <th>UOM</th> </tr> </thead> <tbody> <tr> <td>TB2621B0</td> <td>BAFFLE CHIMNEY</td> <td>1</td> <td>PZ</td> </tr> <tr> <td>VI1220A1</td> <td>4,2X12 TCB SELF-TAPPIN G SCREW</td> <td>11</td> <td>PZ</td> </tr> <tr> <td>VM1059A1</td> <td>HEAT SHRINK FILM H800</td> <td>1.700</td> <td>M</td> </tr> <tr> <td>VM2332A1</td> <td>HUMIDITY PIPES WASHE</td> <td>1</td> <td>PZ</td> </tr> <tr> <td>VM2571A1</td> <td>UPPER WATER DISTRIBUTOR</td> <td>5</td> <td>PZ</td> </tr> <tr> <td>VM2572A1</td> <td>LOWER WATER DISTRIBUTOR</td> <td>5</td> <td>PZ</td> </tr> </tbody> </table>	Code	Description	Qty	UOM	TB2621B0	BAFFLE CHIMNEY	1	PZ	VI1220A1	4,2X12 TCB SELF-TAPPIN G SCREW	11	PZ	VM1059A1	HEAT SHRINK FILM H800	1.700	M	VM2332A1	HUMIDITY PIPES WASHE	1	PZ	VM2571A1	UPPER WATER DISTRIBUTOR	5	PZ	VM2572A1	LOWER WATER DISTRIBUTOR	5	PZ																									
			Code	Description	Qty	UOM																																																				
TB2621B0	BAFFLE CHIMNEY	1	PZ																																																							
VI1220A1	4,2X12 TCB SELF-TAPPIN G SCREW	11	PZ																																																							
VM1059A1	HEAT SHRINK FILM H800	1.700	M																																																							
VM2332A1	HUMIDITY PIPES WASHE	1	PZ																																																							
VM2571A1	UPPER WATER DISTRIBUTOR	5	PZ																																																							
VM2572A1	LOWER WATER DISTRIBUTOR	5	PZ																																																							
K0G1041B	BIG-L GN1/1 PLUS COMPLETE FAN GUARD KIT	<table border="1"> <thead> <tr> <th>Code</th> <th>Description</th> <th>Qty</th> <th>UOM</th> </tr> </thead> <tbody> <tr> <td>0G1041B0</td> <td>XEVL-2011 FAN GUARD</td> <td>1</td> <td>PZ</td> </tr> <tr> <td>IP1508A1</td> <td>POLYSTYREN E U SHAPED PROFILE 2000X60X60</td> <td>3</td> <td>M</td> </tr> <tr> <td>TB2612B0</td> <td>XEVL-20XX 6TH MOTOR INT WATER PIPE</td> <td>1</td> <td>PZ</td> </tr> <tr> <td>TB2614B0</td> <td>XEVL-20XX 5TH MOTOR INT WATER PIPE</td> <td>1</td> <td>PZ</td> </tr> <tr> <td>TB2616B0</td> <td>BAFFLE CHIMNEY</td> <td>1</td> <td>PZ</td> </tr> <tr> <td>TB2618B0</td> <td>BAFFLE CHIMNEY</td> <td>1</td> <td>PZ</td> </tr> <tr> <td>TB2620B0</td> <td>XEVL-20XX 2ND MOTOR INT WATER PIPE</td> <td>1</td> <td>PZ</td> </tr> <tr> <td>TB2621B0</td> <td>BAFFLE CHIMNEY</td> <td>1</td> <td>PZ</td> </tr> <tr> <td>VI1220A1</td> <td>4,2X12 TCB SELF-TAPPIN G SCREW</td> <td>11</td> <td>PZ</td> </tr> <tr> <td>VM1059A1</td> <td>HEAT SHRINK FILM H800</td> <td>1.700</td> <td>M</td> </tr> <tr> <td>VM2332A1</td> <td>HUMIDITY PIPES WASHE</td> <td>1</td> <td>PZ</td> </tr> <tr> <td>VM2571A1</td> <td>UPPER WATER DISTRIBUTOR</td> <td>5</td> <td>PZ</td> </tr> <tr> <td>VM2572A1</td> <td>LOWER WATER DISTRIBUTOR</td> <td>5</td> <td>PZ</td> </tr> </tbody> </table>	Code	Description	Qty	UOM	0G1041B0	XEVL-2011 FAN GUARD	1	PZ	IP1508A1	POLYSTYREN E U SHAPED PROFILE 2000X60X60	3	M	TB2612B0	XEVL-20XX 6TH MOTOR INT WATER PIPE	1	PZ	TB2614B0	XEVL-20XX 5TH MOTOR INT WATER PIPE	1	PZ	TB2616B0	BAFFLE CHIMNEY	1	PZ	TB2618B0	BAFFLE CHIMNEY	1	PZ	TB2620B0	XEVL-20XX 2ND MOTOR INT WATER PIPE	1	PZ	TB2621B0	BAFFLE CHIMNEY	1	PZ	VI1220A1	4,2X12 TCB SELF-TAPPIN G SCREW	11	PZ	VM1059A1	HEAT SHRINK FILM H800	1.700	M	VM2332A1	HUMIDITY PIPES WASHE	1	PZ	VM2571A1	UPPER WATER DISTRIBUTOR	5	PZ	VM2572A1	LOWER WATER DISTRIBUTOR	5	PZ
Code	Description	Qty	UOM																																																							
0G1041B0	XEVL-2011 FAN GUARD	1	PZ																																																							
IP1508A1	POLYSTYREN E U SHAPED PROFILE 2000X60X60	3	M																																																							
TB2612B0	XEVL-20XX 6TH MOTOR INT WATER PIPE	1	PZ																																																							
TB2614B0	XEVL-20XX 5TH MOTOR INT WATER PIPE	1	PZ																																																							
TB2616B0	BAFFLE CHIMNEY	1	PZ																																																							
TB2618B0	BAFFLE CHIMNEY	1	PZ																																																							
TB2620B0	XEVL-20XX 2ND MOTOR INT WATER PIPE	1	PZ																																																							
TB2621B0	BAFFLE CHIMNEY	1	PZ																																																							
VI1220A1	4,2X12 TCB SELF-TAPPIN G SCREW	11	PZ																																																							
VM1059A1	HEAT SHRINK FILM H800	1.700	M																																																							
VM2332A1	HUMIDITY PIPES WASHE	1	PZ																																																							
VM2571A1	UPPER WATER DISTRIBUTOR	5	PZ																																																							
VM2572A1	LOWER WATER DISTRIBUTOR	5	PZ																																																							

COMPONENT			SPARE PART																																																																																					
Code	Description	Image	Code	Description	Components list																																																																																			
TB2621B	BAFFLE CHIMNEY		K0G1059B	BIG-L GN2/1 COMPLETE FAN GUARD KIT	<table border="1"> <thead> <tr> <th>Code</th> <th>Description</th> <th>Qty</th> <th>UOM</th> </tr> </thead> <tbody> <tr> <td>0G1059B0</td> <td>XEVL-2021-EL FAN GUARD</td> <td>1</td> <td>PZ</td> </tr> <tr> <td>IP1508A1</td> <td>POLYSTYREN E U SHAPED PROFILE 2000X60X60</td> <td>1</td> <td>M</td> </tr> <tr> <td>TB2612B0</td> <td>XEVL-20XX 6TH MOTOR INT WATER PIPE</td> <td>1</td> <td>PZ</td> </tr> <tr> <td>TB2614B0</td> <td>XEVL-20XX 5TH MOTOR INT WATER PIPE</td> <td>1</td> <td>PZ</td> </tr> <tr> <td>TB2616B0</td> <td>BAFFLE CHIMNEY</td> <td>1</td> <td>PZ</td> </tr> <tr> <td>TB2618B0</td> <td>BAFFLE CHIMNEY</td> <td>1</td> <td>PZ</td> </tr> <tr> <td>TB2620B0</td> <td>XEVL-20XX 2ND MOTOR INT WATER PIPE</td> <td>1</td> <td>PZ</td> </tr> <tr> <td>TB2621B0</td> <td>BAFFLE CHIMNEY</td> <td>1</td> <td>PZ</td> </tr> <tr> <td>VI1220A1</td> <td>4,2X12 TCB SELF-TAPPIN G SCREW</td> <td>11</td> <td>PZ</td> </tr> <tr> <td>VM1059A1</td> <td>HEAT SHRINK FILM H800</td> <td>1.700</td> <td>M</td> </tr> <tr> <td>VM2332A1</td> <td>HUMIDITY PIPES WASHE</td> <td>1</td> <td>PZ</td> </tr> <tr> <td>VM2571A1</td> <td>UPPER WATER DISTRIBUTOR</td> <td>5</td> <td>PZ</td> </tr> <tr> <td>VM2572A1</td> <td>LOWER WATER DISTRIBUTOR</td> <td>5</td> <td>PZ</td> </tr> </tbody> </table>	Code	Description	Qty	UOM	0G1059B0	XEVL-2021-EL FAN GUARD	1	PZ	IP1508A1	POLYSTYREN E U SHAPED PROFILE 2000X60X60	1	M	TB2612B0	XEVL-20XX 6TH MOTOR INT WATER PIPE	1	PZ	TB2614B0	XEVL-20XX 5TH MOTOR INT WATER PIPE	1	PZ	TB2616B0	BAFFLE CHIMNEY	1	PZ	TB2618B0	BAFFLE CHIMNEY	1	PZ	TB2620B0	XEVL-20XX 2ND MOTOR INT WATER PIPE	1	PZ	TB2621B0	BAFFLE CHIMNEY	1	PZ	VI1220A1	4,2X12 TCB SELF-TAPPIN G SCREW	11	PZ	VM1059A1	HEAT SHRINK FILM H800	1.700	M	VM2332A1	HUMIDITY PIPES WASHE	1	PZ	VM2571A1	UPPER WATER DISTRIBUTOR	5	PZ	VM2572A1	LOWER WATER DISTRIBUTOR	5	PZ	K0G1041B	BIG-L GN1/1 PLUS COMPLETE FAN GUARD KIT	<table border="1"> <thead> <tr> <th>Code</th> <th>Description</th> <th>Qty</th> <th>UOM</th> </tr> </thead> <tbody> <tr> <td>0G1041B0</td> <td>XEVL-2011 FAN GUARD</td> <td>1</td> <td>PZ</td> </tr> <tr> <td>IP1508A1</td> <td>POLYSTYREN E U SHAPED PROFILE 2000X60X60</td> <td>3</td> <td>M</td> </tr> <tr> <td>TB2612B0</td> <td>XEVL-20XX 6TH MOTOR INT WATER PIPE</td> <td>1</td> <td>PZ</td> </tr> <tr> <td>TB2614B0</td> <td>XEVL-20XX 5TH MOTOR INT WATER PIPE</td> <td>1</td> <td>PZ</td> </tr> <tr> <td>TB2616B0</td> <td>BAFFLE CHIMNEY</td> <td>1</td> <td>PZ</td> </tr> </tbody> </table>	Code	Description	Qty	UOM	0G1041B0	XEVL-2011 FAN GUARD	1	PZ	IP1508A1	POLYSTYREN E U SHAPED PROFILE 2000X60X60	3	M	TB2612B0	XEVL-20XX 6TH MOTOR INT WATER PIPE	1	PZ	TB2614B0	XEVL-20XX 5TH MOTOR INT WATER PIPE	1	PZ	TB2616B0	BAFFLE CHIMNEY	1	PZ
			Code	Description	Qty	UOM																																																																																		
0G1059B0	XEVL-2021-EL FAN GUARD	1	PZ																																																																																					
IP1508A1	POLYSTYREN E U SHAPED PROFILE 2000X60X60	1	M																																																																																					
TB2612B0	XEVL-20XX 6TH MOTOR INT WATER PIPE	1	PZ																																																																																					
TB2614B0	XEVL-20XX 5TH MOTOR INT WATER PIPE	1	PZ																																																																																					
TB2616B0	BAFFLE CHIMNEY	1	PZ																																																																																					
TB2618B0	BAFFLE CHIMNEY	1	PZ																																																																																					
TB2620B0	XEVL-20XX 2ND MOTOR INT WATER PIPE	1	PZ																																																																																					
TB2621B0	BAFFLE CHIMNEY	1	PZ																																																																																					
VI1220A1	4,2X12 TCB SELF-TAPPIN G SCREW	11	PZ																																																																																					
VM1059A1	HEAT SHRINK FILM H800	1.700	M																																																																																					
VM2332A1	HUMIDITY PIPES WASHE	1	PZ																																																																																					
VM2571A1	UPPER WATER DISTRIBUTOR	5	PZ																																																																																					
VM2572A1	LOWER WATER DISTRIBUTOR	5	PZ																																																																																					
Code	Description	Qty	UOM																																																																																					
0G1041B0	XEVL-2011 FAN GUARD	1	PZ																																																																																					
IP1508A1	POLYSTYREN E U SHAPED PROFILE 2000X60X60	3	M																																																																																					
TB2612B0	XEVL-20XX 6TH MOTOR INT WATER PIPE	1	PZ																																																																																					
TB2614B0	XEVL-20XX 5TH MOTOR INT WATER PIPE	1	PZ																																																																																					
TB2616B0	BAFFLE CHIMNEY	1	PZ																																																																																					

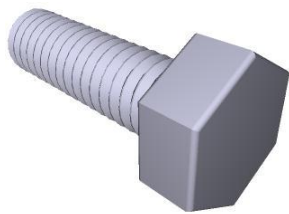
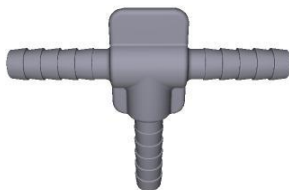

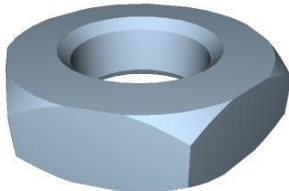
COMPONENT			SPARE PART																																																		
Code	Description	Image	Code	Description	Components list																																																
TB2621B	BAFFLE CHIMNEY		K0G1041B	BIG-L GN1/1 PLUS COMPLETE FAN GUARD KIT	<table border="1"> <thead> <tr> <th>Code</th> <th>Description</th> <th>Qty</th> <th>UOM</th> </tr> </thead> <tbody> <tr> <td>TB2618B0</td> <td>BAFFLE CHIMNEY</td> <td>1</td> <td>PZ</td> </tr> <tr> <td>TB2620B0</td> <td>XEVL-20XX 2ND MOTOR INT WATER PIPE</td> <td>1</td> <td>PZ</td> </tr> <tr> <td>TB2621B0</td> <td>BAFFLE CHIMNEY</td> <td>1</td> <td>PZ</td> </tr> <tr> <td>VI1220A1</td> <td>4,2X12 TCB SELF-TAPPING SCREW</td> <td>11</td> <td>PZ</td> </tr> <tr> <td>VM1059A1</td> <td>HEAT SHRINK FILM H800</td> <td>1.700</td> <td>M</td> </tr> <tr> <td>VM2332A1</td> <td>HUMIDITY PIPES WASHE</td> <td>1</td> <td>PZ</td> </tr> <tr> <td>VM2571A1</td> <td>UPPER WATER DISTRIBUTOR</td> <td>5</td> <td>PZ</td> </tr> <tr> <td>VM2572A1</td> <td>LOWER WATER DISTRIBUTOR</td> <td>5</td> <td>PZ</td> </tr> </tbody> </table>	Code	Description	Qty	UOM	TB2618B0	BAFFLE CHIMNEY	1	PZ	TB2620B0	XEVL-20XX 2ND MOTOR INT WATER PIPE	1	PZ	TB2621B0	BAFFLE CHIMNEY	1	PZ	VI1220A1	4,2X12 TCB SELF-TAPPING SCREW	11	PZ	VM1059A1	HEAT SHRINK FILM H800	1.700	M	VM2332A1	HUMIDITY PIPES WASHE	1	PZ	VM2571A1	UPPER WATER DISTRIBUTOR	5	PZ	VM2572A1	LOWER WATER DISTRIBUTOR	5	PZ												
Code	Description	Qty	UOM																																																		
TB2618B0	BAFFLE CHIMNEY	1	PZ																																																		
TB2620B0	XEVL-20XX 2ND MOTOR INT WATER PIPE	1	PZ																																																		
TB2621B0	BAFFLE CHIMNEY	1	PZ																																																		
VI1220A1	4,2X12 TCB SELF-TAPPING SCREW	11	PZ																																																		
VM1059A1	HEAT SHRINK FILM H800	1.700	M																																																		
VM2332A1	HUMIDITY PIPES WASHE	1	PZ																																																		
VM2571A1	UPPER WATER DISTRIBUTOR	5	PZ																																																		
VM2572A1	LOWER WATER DISTRIBUTOR	5	PZ																																																		
0G1041B	XEVL-2011 FAN GUARD		K0G1041B	BIG-L GN1/1 PLUS COMPLETE FAN GUARD KIT	<table border="1"> <thead> <tr> <th>Code</th> <th>Description</th> <th>Qty</th> <th>UOM</th> </tr> </thead> <tbody> <tr> <td>0G1041B0</td> <td>XEVL-2011 FAN GUARD</td> <td>1</td> <td>PZ</td> </tr> <tr> <td>IP1508A1</td> <td>POLYSTYREN E U SHAPED PROFILE 2000X60X60</td> <td>3</td> <td>M</td> </tr> <tr> <td>TB2612B0</td> <td>XEVL-20XX 6TH MOTOR INT WATER PIPE</td> <td>1</td> <td>PZ</td> </tr> <tr> <td>TB2614B0</td> <td>XEVL-20XX 5TH MOTOR INT WATER PIPE</td> <td>1</td> <td>PZ</td> </tr> <tr> <td>TB2616B0</td> <td>BAFFLE CHIMNEY</td> <td>1</td> <td>PZ</td> </tr> <tr> <td>TB2618B0</td> <td>BAFFLE CHIMNEY</td> <td>1</td> <td>PZ</td> </tr> <tr> <td>TB2620B0</td> <td>XEVL-20XX 2ND MOTOR INT WATER PIPE</td> <td>1</td> <td>PZ</td> </tr> <tr> <td>TB2621B0</td> <td>BAFFLE CHIMNEY</td> <td>1</td> <td>PZ</td> </tr> <tr> <td>VI1220A1</td> <td>4,2X12 TCB SELF-TAPPING SCREW</td> <td>11</td> <td>PZ</td> </tr> <tr> <td>VM1059A1</td> <td>HEAT SHRINK FILM H800</td> <td>1.700</td> <td>M</td> </tr> <tr> <td>VM2332A1</td> <td>HUMIDITY PIPES WASHE</td> <td>1</td> <td>PZ</td> </tr> </tbody> </table>	Code	Description	Qty	UOM	0G1041B0	XEVL-2011 FAN GUARD	1	PZ	IP1508A1	POLYSTYREN E U SHAPED PROFILE 2000X60X60	3	M	TB2612B0	XEVL-20XX 6TH MOTOR INT WATER PIPE	1	PZ	TB2614B0	XEVL-20XX 5TH MOTOR INT WATER PIPE	1	PZ	TB2616B0	BAFFLE CHIMNEY	1	PZ	TB2618B0	BAFFLE CHIMNEY	1	PZ	TB2620B0	XEVL-20XX 2ND MOTOR INT WATER PIPE	1	PZ	TB2621B0	BAFFLE CHIMNEY	1	PZ	VI1220A1	4,2X12 TCB SELF-TAPPING SCREW	11	PZ	VM1059A1	HEAT SHRINK FILM H800	1.700	M	VM2332A1	HUMIDITY PIPES WASHE	1	PZ
Code	Description	Qty	UOM																																																		
0G1041B0	XEVL-2011 FAN GUARD	1	PZ																																																		
IP1508A1	POLYSTYREN E U SHAPED PROFILE 2000X60X60	3	M																																																		
TB2612B0	XEVL-20XX 6TH MOTOR INT WATER PIPE	1	PZ																																																		
TB2614B0	XEVL-20XX 5TH MOTOR INT WATER PIPE	1	PZ																																																		
TB2616B0	BAFFLE CHIMNEY	1	PZ																																																		
TB2618B0	BAFFLE CHIMNEY	1	PZ																																																		
TB2620B0	XEVL-20XX 2ND MOTOR INT WATER PIPE	1	PZ																																																		
TB2621B0	BAFFLE CHIMNEY	1	PZ																																																		
VI1220A1	4,2X12 TCB SELF-TAPPING SCREW	11	PZ																																																		
VM1059A1	HEAT SHRINK FILM H800	1.700	M																																																		
VM2332A1	HUMIDITY PIPES WASHE	1	PZ																																																		



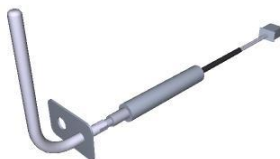
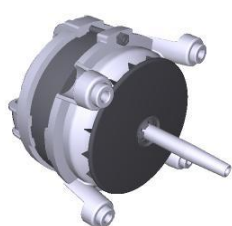

COMPONENT			SPARE PART																																						
Code	Description	Image	Code	Description	Components list																																				
OG1041B	XEVL-2011 FAN GUARD		K0G1041B	BIG-L GN1/1 PLUS COMPLETE FAN GUARD KIT	<table border="1"> <thead> <tr> <th>Code</th> <th>Description</th> <th>Qty</th> <th>UOM</th> </tr> </thead> <tbody> <tr> <td>VM2571A1</td> <td>UPPER WATER DISTRIBUTOR</td> <td>5</td> <td>PZ</td> </tr> <tr> <td>VM2572A1</td> <td>LOWER WATER DISTRIBUTOR</td> <td>5</td> <td>PZ</td> </tr> </tbody> </table>	Code	Description	Qty	UOM	VM2571A1	UPPER WATER DISTRIBUTOR	5	PZ	VM2572A1	LOWER WATER DISTRIBUTOR	5	PZ																								
Code	Description	Qty	UOM																																						
VM2571A1	UPPER WATER DISTRIBUTOR	5	PZ																																						
VM2572A1	LOWER WATER DISTRIBUTOR	5	PZ																																						
GN1668A	RS1102/RS1103 GASKET		KG1668A	RS1102/RS1103 SHOP.PRO GASKET 4PCS KIT	<table border="1"> <thead> <tr> <th>Code</th> <th>Description</th> <th>Qty</th> <th>UOM</th> </tr> </thead> <tbody> <tr> <td>GN1668A0</td> <td>RS1102/RS1103 3 GASKET</td> <td>4</td> <td>PZ</td> </tr> </tbody> </table>	Code	Description	Qty	UOM	GN1668A0	RS1102/RS1103 3 GASKET	4	PZ																												
Code	Description	Qty	UOM																																						
GN1668A0	RS1102/RS1103 3 GASKET	4	PZ																																						
0H2082A	RS1102A COUNTER FLANGE		0H2082A0	RS1102A COUNTER FLANGE																																					
RS1102B	9000W 230V L667 ELEMENT		KRS1102B	9000 W 230V LINEAR HEATING ELEMENT KIT	<table border="1"> <thead> <tr> <th>Code</th> <th>Description</th> <th>Qty</th> <th>UOM</th> </tr> </thead> <tbody> <tr> <td>0H2082A0</td> <td>RS1102A COUNTER FLANGE</td> <td>1</td> <td>PZ</td> </tr> <tr> <td>GN1668A0</td> <td>RS1102/RS1103 3 GASKET</td> <td>1</td> <td>PZ</td> </tr> <tr> <td>RS1102B0</td> <td>9000W 230V L667 ELEMEN</td> <td>1</td> <td>PZ</td> </tr> <tr> <td>VI1109A1</td> <td>316 A4 M5X16 HEXAGONAL SCREW</td> <td>8</td> <td>PZ</td> </tr> <tr> <td>VI1119A0</td> <td>ST.STEEL M6 H8 GRUB SCREW</td> <td>2</td> <td>PZ</td> </tr> <tr> <td>VI1836A0</td> <td>M6X12 OT63 ROTOR SCRE</td> <td>2</td> <td>PZ</td> </tr> <tr> <td>VM1794A0</td> <td>250X4.8 PA66 BLACK CLAMP</td> <td>2</td> <td>PZ</td> </tr> <tr> <td>VM2103A0</td> <td>CLAMP LOCK</td> <td>2</td> <td>PZ</td> </tr> </tbody> </table>	Code	Description	Qty	UOM	0H2082A0	RS1102A COUNTER FLANGE	1	PZ	GN1668A0	RS1102/RS1103 3 GASKET	1	PZ	RS1102B0	9000W 230V L667 ELEMEN	1	PZ	VI1109A1	316 A4 M5X16 HEXAGONAL SCREW	8	PZ	VI1119A0	ST.STEEL M6 H8 GRUB SCREW	2	PZ	VI1836A0	M6X12 OT63 ROTOR SCRE	2	PZ	VM1794A0	250X4.8 PA66 BLACK CLAMP	2	PZ	VM2103A0	CLAMP LOCK	2	PZ
Code	Description	Qty	UOM																																						
0H2082A0	RS1102A COUNTER FLANGE	1	PZ																																						
GN1668A0	RS1102/RS1103 3 GASKET	1	PZ																																						
RS1102B0	9000W 230V L667 ELEMEN	1	PZ																																						
VI1109A1	316 A4 M5X16 HEXAGONAL SCREW	8	PZ																																						
VI1119A0	ST.STEEL M6 H8 GRUB SCREW	2	PZ																																						
VI1836A0	M6X12 OT63 ROTOR SCRE	2	PZ																																						
VM1794A0	250X4.8 PA66 BLACK CLAMP	2	PZ																																						
VM2103A0	CLAMP LOCK	2	PZ																																						

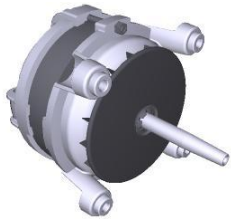

COMPONENT			SPARE PART														
Code	Description	Image	Code	Description	Components list												
VI1109A	316 A4 M5X16 HEXAGONAL SCRE		VI1109A1	316 A4 M5X16 HEXAGONAL SCRE													
VL1127A	6MM BARBED T-SHAPED FITTING		KVL1127A	6MM BARBED T-SHAPED FITTING 10 PCS KIT	<table border="1"> <thead> <tr> <th>Code</th> <th>Description</th> <th>Qty</th> <th>UOM</th> </tr> </thead> <tbody> <tr> <td>VL1127A1</td> <td>6MM BARBED T-SHAPED FITTING</td> <td>10</td> <td>PZ</td> </tr> <tr> <td>VM1224A0</td> <td>65MY 220MM 2 COLOURS SHRINK TUBE</td> <td>0.200</td> <td>M</td> </tr> </tbody> </table>	Code	Description	Qty	UOM	VL1127A1	6MM BARBED T-SHAPED FITTING	10	PZ	VM1224A0	65MY 220MM 2 COLOURS SHRINK TUBE	0.200	M
Code	Description	Qty	UOM														
VL1127A1	6MM BARBED T-SHAPED FITTING	10	PZ														
VM1224A0	65MY 220MM 2 COLOURS SHRINK TUBE	0.200	M														
TB3253A	TB3131A-T SHAPED EXT HUM PIPE CONNECTION		KTB3131A	WHITE-BLACK 6X12 REINFORCED PIPE 3M KIT	<table border="1"> <thead> <tr> <th>Code</th> <th>Description</th> <th>Qty</th> <th>UOM</th> </tr> </thead> <tbody> <tr> <td>TB3131A0</td> <td>WHITE-BLACK EPDM TEXTILE BRAID HOSE 6X12</td> <td>3</td> <td>M</td> </tr> <tr> <td>VM1794A0</td> <td>250X4.8 PA66 BLACK CLAMP</td> <td>1</td> <td>PZ</td> </tr> </tbody> </table>	Code	Description	Qty	UOM	TB3131A0	WHITE-BLACK EPDM TEXTILE BRAID HOSE 6X12	3	M	VM1794A0	250X4.8 PA66 BLACK CLAMP	1	PZ
Code	Description	Qty	UOM														
TB3131A0	WHITE-BLACK EPDM TEXTILE BRAID HOSE 6X12	3	M														
VM1794A0	250X4.8 PA66 BLACK CLAMP	1	PZ														
TB3429A	XEVL EL D10 EXT WATER PIPE + CONNECTOR		TB3429A0	XEVL EL D10 EXT WATER PIPE + CONNECTOR													
VI1121A	A4 CH22 M14X2 H6.4		VI1121A0	A4 CH22 M14X2 H6.4													

COMPONENT			SPARE PART																																																		
Code	Description	Image	Code	Description	Components list																																																
VL1220A			KVL1037A	WASHING SYSTEM ROTOR KIT	<table border="1"> <thead> <tr> <th>Code</th> <th>Description</th> <th>Qty</th> <th>UOM</th> </tr> </thead> <tbody> <tr> <td>GN1416B0</td> <td>WASHING SYSTEM ROTOR BEARING</td> <td>1</td> <td>PZ</td> </tr> <tr> <td>MOV0015A0</td> <td>HOOD RING GASKET GN1110A2</td> <td>0.100</td> <td>PZ</td> </tr> <tr> <td>TF1065B0</td> <td>WASHING SYSTEM ROTOR PIVOT</td> <td>1</td> <td>PZ</td> </tr> <tr> <td>TF1066A1</td> <td>WASHING SYSTEM ROTOR BUSH</td> <td>1</td> <td>PZ</td> </tr> <tr> <td>UG1005B1</td> <td>LONG RAY ROTOR WATER NOZZL</td> <td>1</td> <td>PZ</td> </tr> <tr> <td>UG1006B3</td> <td>LONG RAY ROTOR WATER NOZZL</td> <td>1</td> <td>PZ</td> </tr> <tr> <td>VI1220A1</td> <td>4,2X12 TCB SELF-TAPPIN G SCREW</td> <td>8</td> <td>PZ</td> </tr> <tr> <td>VM1224A0</td> <td>65MY 220MM 2 COLOURS SHRINK TUBE</td> <td>0.250</td> <td>M</td> </tr> <tr> <td>VM1955C0</td> <td>WASHING SYSTEM ROTOR</td> <td>1</td> <td>PZ</td> </tr> <tr> <td>VM1985C1</td> <td>WASHING SYSTEM ROTOR COVE</td> <td>1</td> <td>PZ</td> </tr> <tr> <td>VM1986A0</td> <td>NOZZLE COVE</td> <td>2</td> <td>PZ</td> </tr> </tbody> </table>	Code	Description	Qty	UOM	GN1416B0	WASHING SYSTEM ROTOR BEARING	1	PZ	MOV0015A0	HOOD RING GASKET GN1110A2	0.100	PZ	TF1065B0	WASHING SYSTEM ROTOR PIVOT	1	PZ	TF1066A1	WASHING SYSTEM ROTOR BUSH	1	PZ	UG1005B1	LONG RAY ROTOR WATER NOZZL	1	PZ	UG1006B3	LONG RAY ROTOR WATER NOZZL	1	PZ	VI1220A1	4,2X12 TCB SELF-TAPPIN G SCREW	8	PZ	VM1224A0	65MY 220MM 2 COLOURS SHRINK TUBE	0.250	M	VM1955C0	WASHING SYSTEM ROTOR	1	PZ	VM1985C1	WASHING SYSTEM ROTOR COVE	1	PZ	VM1986A0	NOZZLE COVE	2	PZ
					Code	Description	Qty	UOM																																													
					GN1416B0	WASHING SYSTEM ROTOR BEARING	1	PZ																																													
					MOV0015A0	HOOD RING GASKET GN1110A2	0.100	PZ																																													
					TF1065B0	WASHING SYSTEM ROTOR PIVOT	1	PZ																																													
					TF1066A1	WASHING SYSTEM ROTOR BUSH	1	PZ																																													
					UG1005B1	LONG RAY ROTOR WATER NOZZL	1	PZ																																													
					UG1006B3	LONG RAY ROTOR WATER NOZZL	1	PZ																																													
					VI1220A1	4,2X12 TCB SELF-TAPPIN G SCREW	8	PZ																																													
					VM1224A0	65MY 220MM 2 COLOURS SHRINK TUBE	0.250	M																																													
					VM1955C0	WASHING SYSTEM ROTOR	1	PZ																																													
					VM1985C1	WASHING SYSTEM ROTOR COVE	1	PZ																																													
					VM1986A0	NOZZLE COVE	2	PZ																																													
SN1022A	BENT PT100 CHAMBER TEMPERATURE		KSN1022A	BENT PT100 CHAMBER TEMPERATURE KIT	<table border="1"> <thead> <tr> <th>Code</th> <th>Description</th> <th>Qty</th> <th>UOM</th> </tr> </thead> <tbody> <tr> <td>0H8028A0</td> <td>BIG OVENS CHAMBER PROBE PLATE</td> <td>1</td> <td>PZ</td> </tr> <tr> <td>0H8028A1</td> <td>BIG OVENS CHAMBER PROBE PLATE</td> <td>1</td> <td>PZ</td> </tr> <tr> <td>JEM0620A0</td> <td>SN1022A CHAMBER PROBE SET</td> <td>1</td> <td>PZ</td> </tr> <tr> <td>RC1130A0</td> <td>130X2,6 CLAM</td> <td>2</td> <td>PZ</td> </tr> <tr> <td>SL1045A0</td> <td>S57 BLACK SILICONE - 80ML CARTRIDGE</td> <td>1</td> <td>PZ</td> </tr> <tr> <td>SL1170A1</td> <td>S57 BLACK SILICON - 310ML CARTRIDGE</td> <td>3</td> <td>ML</td> </tr> <tr> <td>SN1022A0</td> <td>BENT PT100 CHAMBER TEMPERATUR</td> <td>1</td> <td>PZ</td> </tr> <tr> <td>VI1220A1</td> <td>4,2X12 TCB SELF-TAPPIN G SCREW</td> <td>2</td> <td>PZ</td> </tr> </tbody> </table>	Code	Description	Qty	UOM	0H8028A0	BIG OVENS CHAMBER PROBE PLATE	1	PZ	0H8028A1	BIG OVENS CHAMBER PROBE PLATE	1	PZ	JEM0620A0	SN1022A CHAMBER PROBE SET	1	PZ	RC1130A0	130X2,6 CLAM	2	PZ	SL1045A0	S57 BLACK SILICONE - 80ML CARTRIDGE	1	PZ	SL1170A1	S57 BLACK SILICON - 310ML CARTRIDGE	3	ML	SN1022A0	BENT PT100 CHAMBER TEMPERATUR	1	PZ	VI1220A1	4,2X12 TCB SELF-TAPPIN G SCREW	2	PZ												
					Code	Description	Qty	UOM																																													
					0H8028A0	BIG OVENS CHAMBER PROBE PLATE	1	PZ																																													
					0H8028A1	BIG OVENS CHAMBER PROBE PLATE	1	PZ																																													
					JEM0620A0	SN1022A CHAMBER PROBE SET	1	PZ																																													
					RC1130A0	130X2,6 CLAM	2	PZ																																													
					SL1045A0	S57 BLACK SILICONE - 80ML CARTRIDGE	1	PZ																																													
					SL1170A1	S57 BLACK SILICON - 310ML CARTRIDGE	3	ML																																													
					SN1022A0	BENT PT100 CHAMBER TEMPERATUR	1	PZ																																													
					VI1220A1	4,2X12 TCB SELF-TAPPIN G SCREW	2	PZ																																													

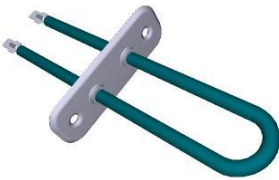

COMPONENT			SPARE PART																																														
Code	Description	Image	Code	Description	Components list																																												
SN1026A	PT100 L2000 CHAMBER TEMPERATURE PROBE		KSN1026A	L=2M PT100 CHAMBER TEMPERATURE PROBE KIT	<table border="1"> <thead> <tr> <th>Code</th> <th>Description</th> <th>Qty</th> <th>UOM</th> </tr> </thead> <tbody> <tr> <td>0H8028A0</td> <td>BIG OVENS CHAMBER PROBE PLATE</td> <td>1</td> <td>PZ</td> </tr> <tr> <td>0H8028A1</td> <td>BIG OVENS CHAMBER PROBE PLATE</td> <td>1</td> <td>PZ</td> </tr> <tr> <td>JEM0621A0</td> <td>SN1026A CHAMBER PROBE SET</td> <td>1</td> <td>PZ</td> </tr> <tr> <td>RC1130A0</td> <td>130X2,6 CLAM</td> <td>2</td> <td>PZ</td> </tr> <tr> <td>SL1045A0</td> <td>S57 BLACK SILICONE - 80ML CARTRIDGE</td> <td>1</td> <td>PZ</td> </tr> <tr> <td>SL1170A1</td> <td>S57 BLACK SILICON - 310ML CARTRIDGE</td> <td>3</td> <td>ML</td> </tr> <tr> <td>SN1026A0</td> <td>PT100 L2000 CHAMBER TEMPERATUR E PROBE</td> <td>1</td> <td>PZ</td> </tr> <tr> <td>VI1220A1</td> <td>4,2X12 TCB SELF-TAPPIN G SCREW</td> <td>2</td> <td>PZ</td> </tr> </tbody> </table>	Code	Description	Qty	UOM	0H8028A0	BIG OVENS CHAMBER PROBE PLATE	1	PZ	0H8028A1	BIG OVENS CHAMBER PROBE PLATE	1	PZ	JEM0621A0	SN1026A CHAMBER PROBE SET	1	PZ	RC1130A0	130X2,6 CLAM	2	PZ	SL1045A0	S57 BLACK SILICONE - 80ML CARTRIDGE	1	PZ	SL1170A1	S57 BLACK SILICON - 310ML CARTRIDGE	3	ML	SN1026A0	PT100 L2000 CHAMBER TEMPERATUR E PROBE	1	PZ	VI1220A1	4,2X12 TCB SELF-TAPPIN G SCREW	2	PZ								
Code	Description	Qty	UOM																																														
0H8028A0	BIG OVENS CHAMBER PROBE PLATE	1	PZ																																														
0H8028A1	BIG OVENS CHAMBER PROBE PLATE	1	PZ																																														
JEM0621A0	SN1026A CHAMBER PROBE SET	1	PZ																																														
RC1130A0	130X2,6 CLAM	2	PZ																																														
SL1045A0	S57 BLACK SILICONE - 80ML CARTRIDGE	1	PZ																																														
SL1170A1	S57 BLACK SILICON - 310ML CARTRIDGE	3	ML																																														
SN1026A0	PT100 L2000 CHAMBER TEMPERATUR E PROBE	1	PZ																																														
VI1220A1	4,2X12 TCB SELF-TAPPIN G SCREW	2	PZ																																														
MT1012A	330W 230V MOTOR		KVN1130A	LUX =08.2017/S.5/S.5E 330W MOTOR KIT	<table border="1"> <thead> <tr> <th>Code</th> <th>Description</th> <th>Qty</th> <th>UOM</th> </tr> </thead> <tbody> <tr> <td>0H4305A1</td> <td>ST. STEEL MOTOR SHAFT SEALING DISC</td> <td>1</td> <td>PZ</td> </tr> <tr> <td>GN1140A2</td> <td>MOTOR HOLDER GASKET</td> <td>1</td> <td>PZ</td> </tr> <tr> <td>GN1140A3</td> <td>MOLDED HOLDER GASKET</td> <td>1</td> <td>PZ</td> </tr> <tr> <td>VI1045A0</td> <td>16X8,4 TH=1,6 ST.STEEL WASHER</td> <td>1</td> <td>PZ</td> </tr> <tr> <td>VI1256A0</td> <td>M8 DIN 980M ST. STEEL SELF LOCKING NUT</td> <td>1</td> <td>PZ</td> </tr> <tr> <td>VM1794A0</td> <td>250X4.8 PA66 BLACK CLAMP</td> <td>4</td> <td>PZ</td> </tr> <tr> <td>VM2103A0</td> <td>CLAMP LOCK</td> <td>4</td> <td>PZ</td> </tr> <tr> <td>VM2196A0</td> <td>MOTOR NUT FASTENING BUSHING</td> <td>1</td> <td>PZ</td> </tr> <tr> <td>VN1130A1</td> <td>330W 230V 50/60HZ MOTO</td> <td>1</td> <td>PZ</td> </tr> <tr> <td>VN1130A1</td> <td>330W 230V 50/60HZ MOTO</td> <td>1</td> <td>PZ</td> </tr> </tbody> </table>	Code	Description	Qty	UOM	0H4305A1	ST. STEEL MOTOR SHAFT SEALING DISC	1	PZ	GN1140A2	MOTOR HOLDER GASKET	1	PZ	GN1140A3	MOLDED HOLDER GASKET	1	PZ	VI1045A0	16X8,4 TH=1,6 ST.STEEL WASHER	1	PZ	VI1256A0	M8 DIN 980M ST. STEEL SELF LOCKING NUT	1	PZ	VM1794A0	250X4.8 PA66 BLACK CLAMP	4	PZ	VM2103A0	CLAMP LOCK	4	PZ	VM2196A0	MOTOR NUT FASTENING BUSHING	1	PZ	VN1130A1	330W 230V 50/60HZ MOTO	1	PZ	VN1130A1	330W 230V 50/60HZ MOTO	1	PZ
Code	Description	Qty	UOM																																														
0H4305A1	ST. STEEL MOTOR SHAFT SEALING DISC	1	PZ																																														
GN1140A2	MOTOR HOLDER GASKET	1	PZ																																														
GN1140A3	MOLDED HOLDER GASKET	1	PZ																																														
VI1045A0	16X8,4 TH=1,6 ST.STEEL WASHER	1	PZ																																														
VI1256A0	M8 DIN 980M ST. STEEL SELF LOCKING NUT	1	PZ																																														
VM1794A0	250X4.8 PA66 BLACK CLAMP	4	PZ																																														
VM2103A0	CLAMP LOCK	4	PZ																																														
VM2196A0	MOTOR NUT FASTENING BUSHING	1	PZ																																														
VN1130A1	330W 230V 50/60HZ MOTO	1	PZ																																														
VN1130A1	330W 230V 50/60HZ MOTO	1	PZ																																														

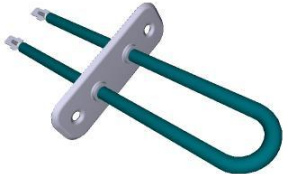
COMPONENT			SPARE PART																																																										
Code	Description	Image	Code	Description	Components list																																																								
MT1012A	330W 230V MOTOR		KMT1012A	MIND.MAPS 330W 230V MOTOR KIT	<table border="1"> <thead> <tr> <th>Code</th> <th>Description</th> <th>Qty</th> <th>UOM</th> </tr> </thead> <tbody> <tr> <td>0H2842A0</td> <td>MT1012 CENTERING JI</td> <td>1</td> <td>PZ</td> </tr> <tr> <td>0H4305A1</td> <td>ST. STEEL MOTOR SHAFT SEALING DISC</td> <td>1</td> <td>PZ</td> </tr> <tr> <td>GN1140A2</td> <td>MOTOR HOLDER GASKET</td> <td>1</td> <td>PZ</td> </tr> <tr> <td>GN1140A3</td> <td>MOLDED MOTOR HOLDER GASKET</td> <td>1</td> <td>PZ</td> </tr> <tr> <td>MOV0007A0</td> <td>HOOD RING GASKET GN1110A2</td> <td>0.100</td> <td>PZ</td> </tr> <tr> <td>MT1012A0</td> <td>330W 230V MOTOR</td> <td>1</td> <td>PZ</td> </tr> <tr> <td>VE1550A0</td> <td>5X3 MM NEODYMIUM MAGNET</td> <td>1</td> <td>PZ</td> </tr> <tr> <td>VI1077A1</td> <td>SCREW M6X12 TE INOX</td> <td>1</td> <td>PZ</td> </tr> <tr> <td>VI1521A0</td> <td>STAINLESS STEEL WASHER D=6 6592</td> <td>1</td> <td>PZ</td> </tr> <tr> <td>VI1966A0</td> <td>M4X14 FLATHEAD SCREW</td> <td>1</td> <td>PZ</td> </tr> <tr> <td>VM1635A0</td> <td>MAGNET HOLDING DIS</td> <td>1</td> <td>PZ</td> </tr> <tr> <td>VM1794A0</td> <td>250X4.8 PA66 BLACK CLAMP</td> <td>4</td> <td>PZ</td> </tr> <tr> <td>VM2103A0</td> <td>CLAMP LOCK</td> <td>4</td> <td>PZ</td> </tr> </tbody> </table>	Code	Description	Qty	UOM	0H2842A0	MT1012 CENTERING JI	1	PZ	0H4305A1	ST. STEEL MOTOR SHAFT SEALING DISC	1	PZ	GN1140A2	MOTOR HOLDER GASKET	1	PZ	GN1140A3	MOLDED MOTOR HOLDER GASKET	1	PZ	MOV0007A0	HOOD RING GASKET GN1110A2	0.100	PZ	MT1012A0	330W 230V MOTOR	1	PZ	VE1550A0	5X3 MM NEODYMIUM MAGNET	1	PZ	VI1077A1	SCREW M6X12 TE INOX	1	PZ	VI1521A0	STAINLESS STEEL WASHER D=6 6592	1	PZ	VI1966A0	M4X14 FLATHEAD SCREW	1	PZ	VM1635A0	MAGNET HOLDING DIS	1	PZ	VM1794A0	250X4.8 PA66 BLACK CLAMP	4	PZ	VM2103A0	CLAMP LOCK	4	PZ
					Code	Description	Qty	UOM																																																					
					0H2842A0	MT1012 CENTERING JI	1	PZ																																																					
					0H4305A1	ST. STEEL MOTOR SHAFT SEALING DISC	1	PZ																																																					
					GN1140A2	MOTOR HOLDER GASKET	1	PZ																																																					
					GN1140A3	MOLDED MOTOR HOLDER GASKET	1	PZ																																																					
					MOV0007A0	HOOD RING GASKET GN1110A2	0.100	PZ																																																					
					MT1012A0	330W 230V MOTOR	1	PZ																																																					
					VE1550A0	5X3 MM NEODYMIUM MAGNET	1	PZ																																																					
					VI1077A1	SCREW M6X12 TE INOX	1	PZ																																																					
					VI1521A0	STAINLESS STEEL WASHER D=6 6592	1	PZ																																																					
					VI1966A0	M4X14 FLATHEAD SCREW	1	PZ																																																					
					VM1635A0	MAGNET HOLDING DIS	1	PZ																																																					
VM1794A0	250X4.8 PA66 BLACK CLAMP	4	PZ																																																										
VM2103A0	CLAMP LOCK	4	PZ																																																										
VN1170B	D195 H80 8 BLADES FAN+RING		KVN1170B	D195 H80 8 BLADES FAN + RING KIT	<table border="1"> <thead> <tr> <th>Code</th> <th>Description</th> <th>Qty</th> <th>UOM</th> </tr> </thead> <tbody> <tr> <td>VI1077A1</td> <td>SCREW M6X12 TE INOX</td> <td>1</td> <td>PZ</td> </tr> <tr> <td>VI1521A0</td> <td>STAINLESS STEEL WASHER D=6 6592</td> <td>1</td> <td>PZ</td> </tr> <tr> <td>VN1170B0</td> <td>D195 H80 8 BLADES FAN+RING</td> <td>1</td> <td>PZ</td> </tr> <tr> <td>VN1170B0</td> <td>D195 H80 8 BLADES FAN+RING</td> <td>1</td> <td>PZ</td> </tr> </tbody> </table>	Code	Description	Qty	UOM	VI1077A1	SCREW M6X12 TE INOX	1	PZ	VI1521A0	STAINLESS STEEL WASHER D=6 6592	1	PZ	VN1170B0	D195 H80 8 BLADES FAN+RING	1	PZ	VN1170B0	D195 H80 8 BLADES FAN+RING	1	PZ																																				
					Code	Description	Qty	UOM																																																					
					VI1077A1	SCREW M6X12 TE INOX	1	PZ																																																					
					VI1521A0	STAINLESS STEEL WASHER D=6 6592	1	PZ																																																					
VN1170B0	D195 H80 8 BLADES FAN+RING	1	PZ																																																										
VN1170B0	D195 H80 8 BLADES FAN+RING	1	PZ																																																										

COMPONENT			SPARE PART																		
Code	Description	Image	Code	Description	Components list																
GN1140A	MOLDED MOTOR HOLDER GASKET		KGN1140A	5 PCS. MOTOR HOLDER GASKET KI	<table border="1"> <thead> <tr> <th>Code</th> <th>Description</th> <th>Qty</th> <th>UOM</th> </tr> </thead> <tbody> <tr> <td>GN1140A2</td> <td>MOTOR HOLDER GASKET</td> <td>5</td> <td>PZ</td> </tr> <tr> <td>GN1140A3</td> <td>MOLDED MOTOR HOLDER GASKET</td> <td>5</td> <td>PZ</td> </tr> <tr> <td>VM1224A0</td> <td>65MY 220MM 2 COLOURS SHRINK TUBE</td> <td>0.200</td> <td>M</td> </tr> </tbody> </table>	Code	Description	Qty	UOM	GN1140A2	MOTOR HOLDER GASKET	5	PZ	GN1140A3	MOLDED MOTOR HOLDER GASKET	5	PZ	VM1224A0	65MY 220MM 2 COLOURS SHRINK TUBE	0.200	M
					Code	Description	Qty	UOM													
					GN1140A2	MOTOR HOLDER GASKET	5	PZ													
GN1140A3	MOLDED MOTOR HOLDER GASKET	5	PZ																		
VM1224A0	65MY 220MM 2 COLOURS SHRINK TUBE	0.200	M																		
0H8118A	XEVL MOTOR SHAFT DISC		0H8118A0	XEVL MOTOR SHAFT DISC																	
VM1387A	THERMOSTAT LOCKING WASHER		KVM1387A	THERMOSTAT LOCKING WASHER KIT																	
0H2163B	TR1161 SAFETY THERMOSTAT BULB HOLDER		KTR1161A	350 °C SAFETY THERMOSTAT KIT	<table border="1"> <thead> <tr> <th>Code</th> <th>Description</th> <th>Qty</th> <th>UOM</th> </tr> </thead> <tbody> <tr> <td>0H2163B0</td> <td>TR1161 SAFETY THERMOSTAT BULB HOLDER</td> <td>1</td> <td>PZ</td> </tr> <tr> <td>TR1161A0</td> <td></td> <td>1</td> <td>PZ</td> </tr> <tr> <td>TR1161A1</td> <td>350 °C UNIPOLAR SAFETY THERMOSTAT</td> <td>1</td> <td>PZ</td> </tr> </tbody> </table>	Code	Description	Qty	UOM	0H2163B0	TR1161 SAFETY THERMOSTAT BULB HOLDER	1	PZ	TR1161A0		1	PZ	TR1161A1	350 °C UNIPOLAR SAFETY THERMOSTAT	1	PZ
					Code	Description	Qty	UOM													
					0H2163B0	TR1161 SAFETY THERMOSTAT BULB HOLDER	1	PZ													
TR1161A0		1	PZ																		
TR1161A1	350 °C UNIPOLAR SAFETY THERMOSTAT	1	PZ																		
RS1215B	1 TURN 147W 105V FLAT ELEMENT		KRS1215B	147W MOTOR BRAKING ELEMENT KIT	<table border="1"> <thead> <tr> <th>Code</th> <th>Description</th> <th>Qty</th> <th>UOM</th> </tr> </thead> <tbody> <tr> <td>GN1672A1</td> <td>RS1274A ELEMENT GASKET</td> <td>1</td> <td>PZ</td> </tr> <tr> <td>MOV0009A0</td> <td>HOOD RING GASKET</td> <td>0.100</td> <td>PZ</td> </tr> <tr> <td>RS1215B0</td> <td>1 TURN 147W 105V FLAT ELEMENT</td> <td>1</td> <td>PZ</td> </tr> </tbody> </table>	Code	Description	Qty	UOM	GN1672A1	RS1274A ELEMENT GASKET	1	PZ	MOV0009A0	HOOD RING GASKET	0.100	PZ	RS1215B0	1 TURN 147W 105V FLAT ELEMENT	1	PZ
					Code	Description	Qty	UOM													
					GN1672A1	RS1274A ELEMENT GASKET	1	PZ													
MOV0009A0	HOOD RING GASKET	0.100	PZ																		
RS1215B0	1 TURN 147W 105V FLAT ELEMENT	1	PZ																		

COMPONENT			SPARE PART																							
Code	Description	Image	Code	Description	Components list																					
RS1215B	1 TURN 147W 105V FLAT ELEMENT		KRS1215B	147W MOTOR BRAKING ELEMENT KIT	<table border="1"> <thead> <tr> <th>Code</th> <th>Description</th> <th>Qty</th> <th>UOM</th> </tr> </thead> <tbody> <tr> <td>SL1045A0</td> <td>S57 BLACK SILICONE - 80ML CARTRIDGE</td> <td>1</td> <td>PZ</td> </tr> <tr> <td>VI1220A1</td> <td>4,2X12 TCB SELF-TAPPIN G SCREW</td> <td>2</td> <td>PZ</td> </tr> </tbody> </table>	Code	Description	Qty	UOM	SL1045A0	S57 BLACK SILICONE - 80ML CARTRIDGE	1	PZ	VI1220A1	4,2X12 TCB SELF-TAPPIN G SCREW	2	PZ									
			Code	Description	Qty	UOM																				
SL1045A0	S57 BLACK SILICONE - 80ML CARTRIDGE	1	PZ																							
VI1220A1	4,2X12 TCB SELF-TAPPIN G SCREW	2	PZ																							
KRS0026A	BIG-L 147W MOTOR BRAKING ELEMENT KIT	<table border="1"> <thead> <tr> <th>Code</th> <th>Description</th> <th>Qty</th> <th>UOM</th> </tr> </thead> <tbody> <tr> <td>GN1672A0</td> <td>RS1274A/RS12 15A BREAKING ELEMENT GASKET</td> <td>1</td> <td>PZ</td> </tr> <tr> <td>GN1672A1</td> <td>RS1274A ELEMENT GASKET</td> <td>1</td> <td>PZ</td> </tr> <tr> <td>RS1215A1</td> <td>147W 105V BRAKING ELEMENT</td> <td>1</td> <td>PZ</td> </tr> <tr> <td>SL1045A0</td> <td>S57 BLACK SILICONE - 80ML CARTRIDGE</td> <td>1</td> <td>PZ</td> </tr> <tr> <td>VI1220A1</td> <td>4,2X12 TCB SELF-TAPPIN G SCREW</td> <td>2</td> <td>PZ</td> </tr> </tbody> </table>	Code	Description	Qty	UOM	GN1672A0	RS1274A/RS12 15A BREAKING ELEMENT GASKET	1	PZ	GN1672A1	RS1274A ELEMENT GASKET	1	PZ	RS1215A1	147W 105V BRAKING ELEMENT	1	PZ	SL1045A0	S57 BLACK SILICONE - 80ML CARTRIDGE	1	PZ	VI1220A1	4,2X12 TCB SELF-TAPPIN G SCREW	2	PZ
Code	Description	Qty	UOM																							
GN1672A0	RS1274A/RS12 15A BREAKING ELEMENT GASKET	1	PZ																							
GN1672A1	RS1274A ELEMENT GASKET	1	PZ																							
RS1215A1	147W 105V BRAKING ELEMENT	1	PZ																							
SL1045A0	S57 BLACK SILICONE - 80ML CARTRIDGE	1	PZ																							
VI1220A1	4,2X12 TCB SELF-TAPPIN G SCREW	2	PZ																							
GN1672A	RS1274A ELEMENT GASKET		KG1672A	71X19 HEATING ELEMENT GASKET 5 PCS KIT	<table border="1"> <thead> <tr> <th>Code</th> <th>Description</th> <th>Qty</th> <th>UOM</th> </tr> </thead> <tbody> <tr> <td>GN1672A0</td> <td>RS1274A/RS12 15A BREAKING ELEMENT GASKET</td> <td>5</td> <td>PZ</td> </tr> <tr> <td>GN1672A1</td> <td>RS1274A ELEMENT GASKET</td> <td>5</td> <td>PZ</td> </tr> <tr> <td>VM1224A0</td> <td>65MY 220MM 2 COLOURS SHRINK TUBE</td> <td>0.250</td> <td>M</td> </tr> </tbody> </table>	Code	Description	Qty	UOM	GN1672A0	RS1274A/RS12 15A BREAKING ELEMENT GASKET	5	PZ	GN1672A1	RS1274A ELEMENT GASKET	5	PZ	VM1224A0	65MY 220MM 2 COLOURS SHRINK TUBE	0.250	M					
Code	Description	Qty	UOM																							
GN1672A0	RS1274A/RS12 15A BREAKING ELEMENT GASKET	5	PZ																							
GN1672A1	RS1274A ELEMENT GASKET	5	PZ																							
VM1224A0	65MY 220MM 2 COLOURS SHRINK TUBE	0.250	M																							
RS1274B	1 TURN 100W 60V FLAT ELEMENT		KRS1274B	100W MOTOR BRAKING ELEMENT KIT	<table border="1"> <thead> <tr> <th>Code</th> <th>Description</th> <th>Qty</th> <th>UOM</th> </tr> </thead> <tbody> <tr> <td>GN1672A1</td> <td>RS1274A ELEMENT GASKET</td> <td>1</td> <td>PZ</td> </tr> <tr> <td>MOV0009A0</td> <td>HOOD RING GASKET GN1110A2</td> <td>0.100</td> <td>PZ</td> </tr> <tr> <td>RS1274B0</td> <td>1 TURN 100W 60V FLAT ELEMENT</td> <td>1</td> <td>PZ</td> </tr> </tbody> </table>	Code	Description	Qty	UOM	GN1672A1	RS1274A ELEMENT GASKET	1	PZ	MOV0009A0	HOOD RING GASKET GN1110A2	0.100	PZ	RS1274B0	1 TURN 100W 60V FLAT ELEMENT	1	PZ					
Code	Description	Qty	UOM																							
GN1672A1	RS1274A ELEMENT GASKET	1	PZ																							
MOV0009A0	HOOD RING GASKET GN1110A2	0.100	PZ																							
RS1274B0	1 TURN 100W 60V FLAT ELEMENT	1	PZ																							



COMPONENT			SPARE PART																		
Code	Description	Image	Code	Description	Components list																
RS1274B	1 TURN 100W 60V FLAT ELEMENT		KRS1274B	100W MOTOR BRAKING ELEMENT KIT	<table border="1"> <thead> <tr> <th>Code</th> <th>Description</th> <th>Qty</th> <th>UOM</th> </tr> </thead> <tbody> <tr> <td>SL1045A0</td> <td>S57 BLACK SILICONE - 80ML CARTRIDGE</td> <td>1</td> <td>PZ</td> </tr> <tr> <td>VI1220A1</td> <td>4,2X12 TCB SELF-TAPPIN G SCREW</td> <td>2</td> <td>PZ</td> </tr> </tbody> </table>	Code	Description	Qty	UOM	SL1045A0	S57 BLACK SILICONE - 80ML CARTRIDGE	1	PZ	VI1220A1	4,2X12 TCB SELF-TAPPIN G SCREW	2	PZ				
					Code	Description	Qty	UOM													
SL1045A0	S57 BLACK SILICONE - 80ML CARTRIDGE	1	PZ																		
VI1220A1	4,2X12 TCB SELF-TAPPIN G SCREW	2	PZ																		
GN1672A	RS1274A ELEMENT GASKET		KGN1672A	71X19 HEATING ELEMENT GASKET 5 PCS KIT	<table border="1"> <thead> <tr> <th>Code</th> <th>Description</th> <th>Qty</th> <th>UOM</th> </tr> </thead> <tbody> <tr> <td>GN1672A0</td> <td>RS1274A/RS12 15A BREAKING ELEMENT GASKET</td> <td>5</td> <td>PZ</td> </tr> <tr> <td>GN1672A1</td> <td>RS1274A ELEMENT GASKET</td> <td>5</td> <td>PZ</td> </tr> <tr> <td>VM1224A0</td> <td>65MY 220MM 2 COLOURS SHRINK TUBE</td> <td>0.250</td> <td>M</td> </tr> </tbody> </table>	Code	Description	Qty	UOM	GN1672A0	RS1274A/RS12 15A BREAKING ELEMENT GASKET	5	PZ	GN1672A1	RS1274A ELEMENT GASKET	5	PZ	VM1224A0	65MY 220MM 2 COLOURS SHRINK TUBE	0.250	M
Code	Description	Qty	UOM																		
GN1672A0	RS1274A/RS12 15A BREAKING ELEMENT GASKET	5	PZ																		
GN1672A1	RS1274A ELEMENT GASKET	5	PZ																		
VM1224A0	65MY 220MM 2 COLOURS SHRINK TUBE	0.250	M																		



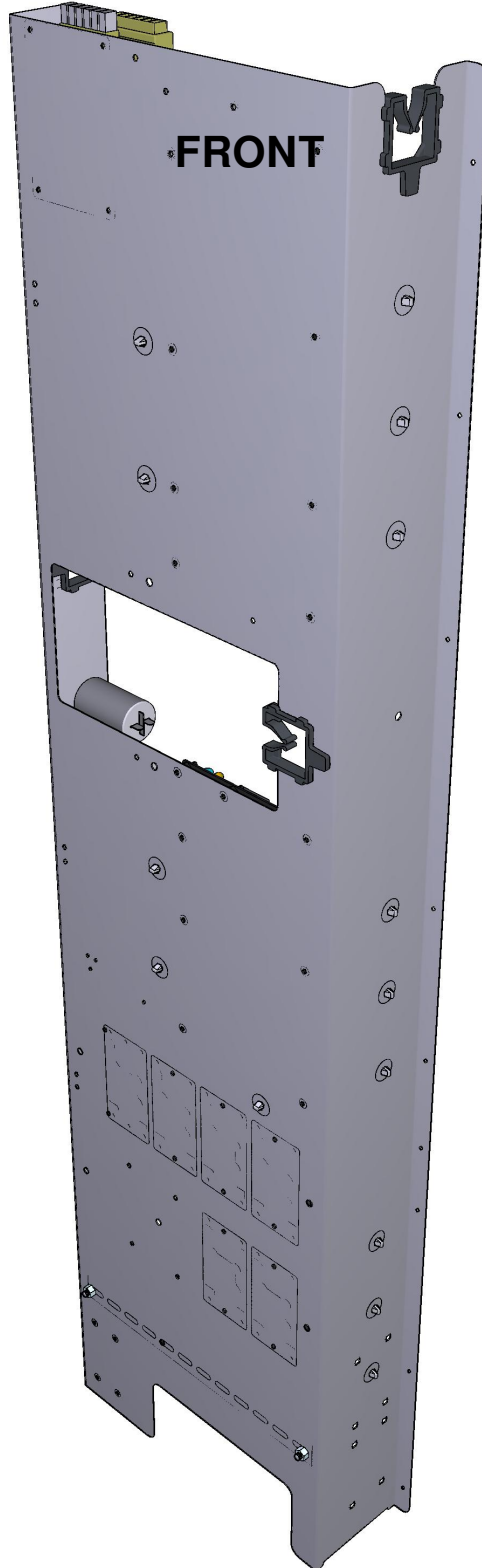

ASM3308A/0.D02 - Electrical system

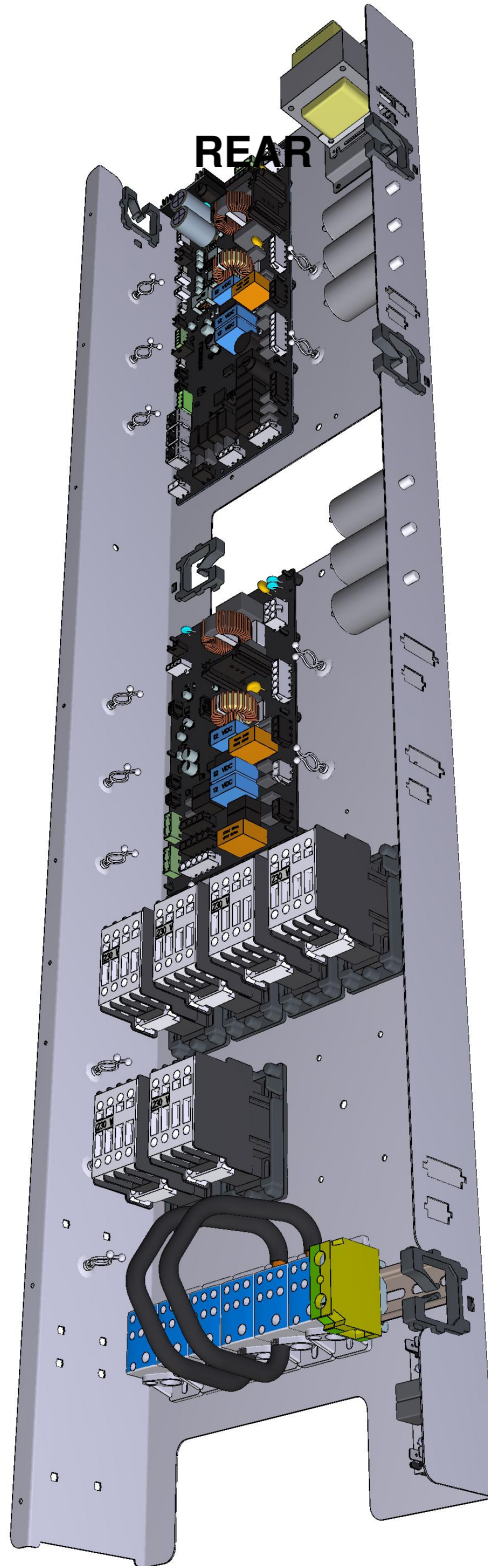



ASM3308A/0.D02 - Electrical system

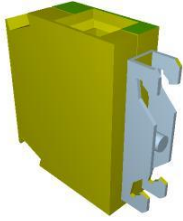

COMPONENT			SPARE PART																										
Code	Description	Image	Code	Description	Components list																								
CN1003A	6,3 UF MOTOR CAPACITOR		KCN1003A	6,3 UF MOTOR CAPACITOR KIT	<table border="1"> <thead> <tr> <th>Code</th> <th>Description</th> <th>Qty</th> <th>UOM</th> </tr> </thead> <tbody> <tr> <td>CN1003A0</td> <td>6,3 UF MOTOR CAPACITOR</td> <td>1</td> <td>PZ</td> </tr> <tr> <td>VI1931A0</td> <td>M8 NUT+INDENTE D WASHER D=8 X COND.</td> <td>1</td> <td>PZ</td> </tr> <tr> <td>VI1932A0</td> <td>M8 NUT+INDENTE D WASHER D=8 X COND.</td> <td>1</td> <td>PZ</td> </tr> <tr> <td>VM1224A0</td> <td>65MY 220MM 2 COLOURS SHRINK TUBE</td> <td>0.200</td> <td>M</td> </tr> </tbody> </table>	Code	Description	Qty	UOM	CN1003A0	6,3 UF MOTOR CAPACITOR	1	PZ	VI1931A0	M8 NUT+INDENTE D WASHER D=8 X COND.	1	PZ	VI1932A0	M8 NUT+INDENTE D WASHER D=8 X COND.	1	PZ	VM1224A0	65MY 220MM 2 COLOURS SHRINK TUBE	0.200	M				
Code	Description	Qty	UOM																										
CN1003A0	6,3 UF MOTOR CAPACITOR	1	PZ																										
VI1931A0	M8 NUT+INDENTE D WASHER D=8 X COND.	1	PZ																										
VI1932A0	M8 NUT+INDENTE D WASHER D=8 X COND.	1	PZ																										
VM1224A0	65MY 220MM 2 COLOURS SHRINK TUBE	0.200	M																										
VM1745A	CARD SUPPORT		KVM1745A	BOARD SUPPORT 10 PCS KIT	<table border="1"> <thead> <tr> <th>Code</th> <th>Description</th> <th>Qty</th> <th>UOM</th> </tr> </thead> <tbody> <tr> <td>VM1224A0</td> <td>65MY 220MM 2 COLOURS SHRINK TUBE</td> <td>0.200</td> <td>M</td> </tr> <tr> <td>VM1745A0</td> <td>CARD SUPPORT</td> <td>10</td> <td>PZ</td> </tr> </tbody> </table>	Code	Description	Qty	UOM	VM1224A0	65MY 220MM 2 COLOURS SHRINK TUBE	0.200	M	VM1745A0	CARD SUPPORT	10	PZ												
Code	Description	Qty	UOM																										
VM1224A0	65MY 220MM 2 COLOURS SHRINK TUBE	0.200	M																										
VM1745A0	CARD SUPPORT	10	PZ																										
PE2038A	MIND.MAPS PLUS POWER BOARD		KPE2038A	MIND.MAPS PLUS POWER BOARD KIT	<table border="1"> <thead> <tr> <th>Code</th> <th>Description</th> <th>Qty</th> <th>UOM</th> </tr> </thead> <tbody> <tr> <td>MOV0003A0</td> <td>HOOD RING GASKET GN1110A2</td> <td>0.100</td> <td>PZ</td> </tr> <tr> <td>PE2038A0</td> <td>MIND.MAPS PLUS POWER BOARD</td> <td>1</td> <td>PZ</td> </tr> <tr> <td>VI1850A0</td> <td>M4X6 NICKEL PLATED FIXING SCRE</td> <td>12</td> <td>PZ</td> </tr> <tr> <td>VM1745A0</td> <td>CARD SUPPORT</td> <td>12</td> <td>PZ</td> </tr> <tr> <td>VM2147A0</td> <td>410X343X15 MM PINK SMOOTH ESD SPONGE</td> <td>1</td> <td>PZ</td> </tr> </tbody> </table>	Code	Description	Qty	UOM	MOV0003A0	HOOD RING GASKET GN1110A2	0.100	PZ	PE2038A0	MIND.MAPS PLUS POWER BOARD	1	PZ	VI1850A0	M4X6 NICKEL PLATED FIXING SCRE	12	PZ	VM1745A0	CARD SUPPORT	12	PZ	VM2147A0	410X343X15 MM PINK SMOOTH ESD SPONGE	1	PZ
Code	Description	Qty	UOM																										
MOV0003A0	HOOD RING GASKET GN1110A2	0.100	PZ																										
PE2038A0	MIND.MAPS PLUS POWER BOARD	1	PZ																										
VI1850A0	M4X6 NICKEL PLATED FIXING SCRE	12	PZ																										
VM1745A0	CARD SUPPORT	12	PZ																										
VM2147A0	410X343X15 MM PINK SMOOTH ESD SPONGE	1	PZ																										
VE1026A	230-21-12VAC 80VA TRANSFORMER		KVE1026A	230-21-12VAC 90VA TRANSFORMER KIT	<table border="1"> <thead> <tr> <th>Code</th> <th>Description</th> <th>Qty</th> <th>UOM</th> </tr> </thead> <tbody> <tr> <td>MOV0012A0</td> <td>HOOD RING GASKET GN1110A2</td> <td>0.100</td> <td>PZ</td> </tr> <tr> <td>VE1026A0</td> <td>230-21-12VAC 80VA TRANSFORME</td> <td>1</td> <td>PZ</td> </tr> <tr> <td>VI1950A0</td> <td>ST. STEEL 4,2X13 TCB SELF-DRILLIN G SCREW</td> <td>4</td> <td>PZ</td> </tr> </tbody> </table>	Code	Description	Qty	UOM	MOV0012A0	HOOD RING GASKET GN1110A2	0.100	PZ	VE1026A0	230-21-12VAC 80VA TRANSFORME	1	PZ	VI1950A0	ST. STEEL 4,2X13 TCB SELF-DRILLIN G SCREW	4	PZ								
Code	Description	Qty	UOM																										
MOV0012A0	HOOD RING GASKET GN1110A2	0.100	PZ																										
VE1026A0	230-21-12VAC 80VA TRANSFORME	1	PZ																										
VI1950A0	ST. STEEL 4,2X13 TCB SELF-DRILLIN G SCREW	4	PZ																										

COMPONENT			SPARE PART																						
Code	Description	Image	Code	Description	Components list																				
VM1188A	BL SHOP.PRO POWER BOARD WIRE PASSAGE		KVM1188A	BL SP POWER BOARD WIRE PASSAGE 10 PC KIT	<table border="1"> <thead> <tr> <th>Code</th> <th>Description</th> <th>Qty</th> <th>UOM</th> </tr> </thead> <tbody> <tr> <td>VM1188A0</td> <td>BL SHOP.PRO POWER BOARD WIRE PASSAGE</td> <td>10</td> <td>PZ</td> </tr> <tr> <td>VM1224A0</td> <td>65MY 220MM 2 COLOURS SHRINK TUBE</td> <td>0.200</td> <td>M</td> </tr> </tbody> </table>	Code	Description	Qty	UOM	VM1188A0	BL SHOP.PRO POWER BOARD WIRE PASSAGE	10	PZ	VM1224A0	65MY 220MM 2 COLOURS SHRINK TUBE	0.200	M								
Code	Description	Qty	UOM																						
VM1188A0	BL SHOP.PRO POWER BOARD WIRE PASSAGE	10	PZ																						
VM1224A0	65MY 220MM 2 COLOURS SHRINK TUBE	0.200	M																						
PE1039A	220-240V TWO-PHASE EMC FILTER CARD		KPE1039A	220-240V EMC TWO-PHASE FILTER CARD KIT	<table border="1"> <thead> <tr> <th>Code</th> <th>Description</th> <th>Qty</th> <th>UOM</th> </tr> </thead> <tbody> <tr> <td>PE1039A0</td> <td>220-240V TWO-PHASE EMC FILTER CARD</td> <td>1</td> <td>PZ</td> </tr> <tr> <td>VM2147A0</td> <td>410X343X15 MM PINK SMOOTH ESD SPONGE</td> <td>1</td> <td>PZ</td> </tr> </tbody> </table>	Code	Description	Qty	UOM	PE1039A0	220-240V TWO-PHASE EMC FILTER CARD	1	PZ	VM2147A0	410X343X15 MM PINK SMOOTH ESD SPONGE	1	PZ								
Code	Description	Qty	UOM																						
PE1039A0	220-240V TWO-PHASE EMC FILTER CARD	1	PZ																						
VM2147A0	410X343X15 MM PINK SMOOTH ESD SPONGE	1	PZ																						
0H2122A	XEVL BIG TRANSFORMERS SUPPORT		0H2122A0	XEVL BIG TRANSFORMERS SUPPORT																					
PE2143B	POWER CARD 3 MOTOR L2 MM+PT1000		KPE2143B	3 MOTORS POWER CARD+CORE PROBE KIT	<table border="1"> <thead> <tr> <th>Code</th> <th>Description</th> <th>Qty</th> <th>UOM</th> </tr> </thead> <tbody> <tr> <td>PE2143B0</td> <td>POWER CARD 3 MOTOR L2 MM+PT1000</td> <td>1</td> <td>PZ</td> </tr> <tr> <td>VI1850A0</td> <td>M4X6 NICKEL PLATED FIXING SCORE</td> <td>8</td> <td>PZ</td> </tr> <tr> <td>VM1745A0</td> <td>CARD SUPPORT</td> <td>8</td> <td>PZ</td> </tr> <tr> <td>VM2147A0</td> <td>410X343X15 MM PINK SMOOTH ESD SPONGE</td> <td>1</td> <td>PZ</td> </tr> </tbody> </table>	Code	Description	Qty	UOM	PE2143B0	POWER CARD 3 MOTOR L2 MM+PT1000	1	PZ	VI1850A0	M4X6 NICKEL PLATED FIXING SCORE	8	PZ	VM1745A0	CARD SUPPORT	8	PZ	VM2147A0	410X343X15 MM PINK SMOOTH ESD SPONGE	1	PZ
Code	Description	Qty	UOM																						
PE2143B0	POWER CARD 3 MOTOR L2 MM+PT1000	1	PZ																						
VI1850A0	M4X6 NICKEL PLATED FIXING SCORE	8	PZ																						
VM1745A0	CARD SUPPORT	8	PZ																						
VM2147A0	410X343X15 MM PINK SMOOTH ESD SPONGE	1	PZ																						
VM2191A	VE1095 BIG SWITCH BRACKET		VM2191A0	VE1095 BIG SWITCH BRACKET																					



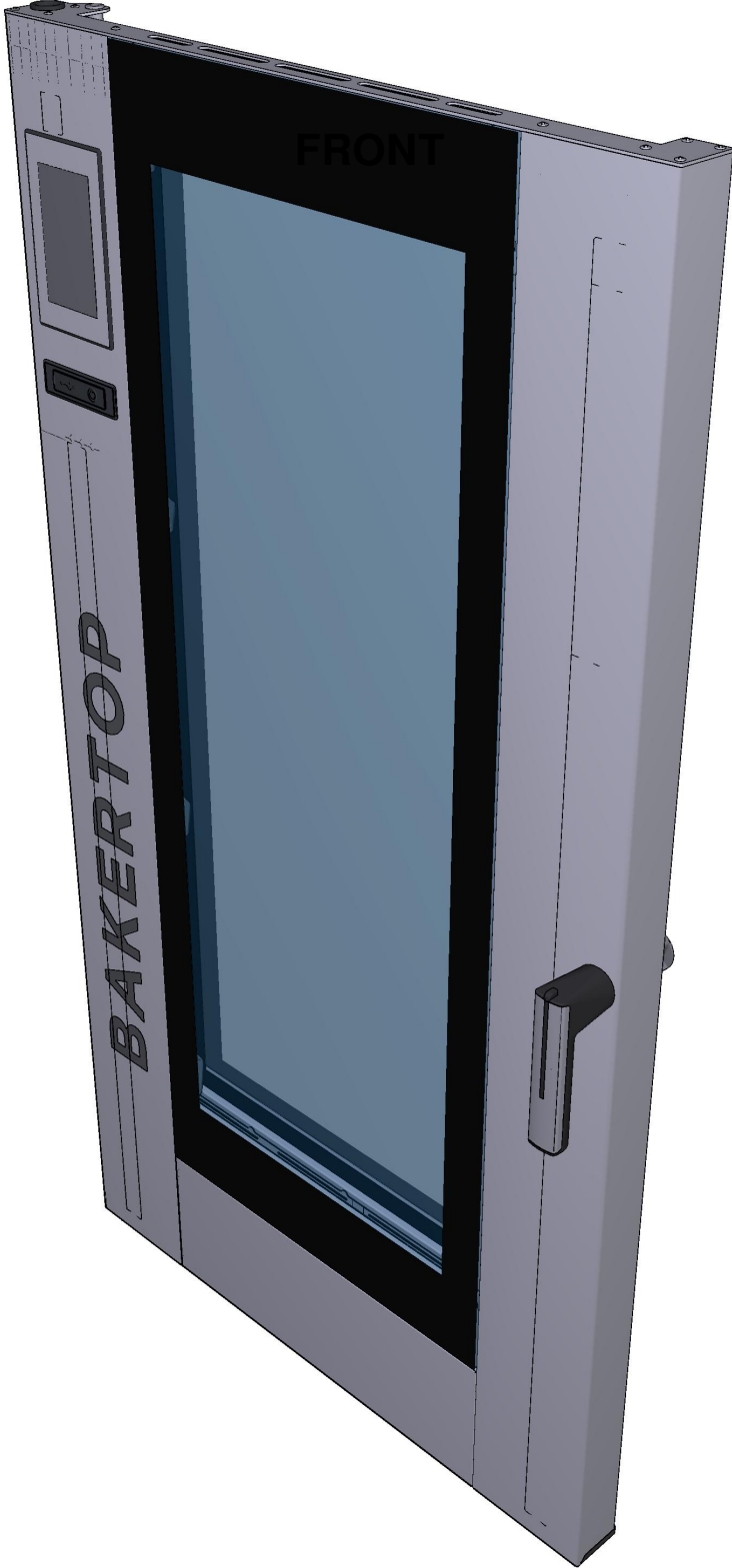

COMPONENT			SPARE PART																						
Code	Description	Image	Code	Description	Components list																				
VE1095A	GE 25A 230V REMOTE CONTROL SWITCH		KVE1095A	HEATING ELEMENT CONTACTOR KIT	<table border="1"> <thead> <tr> <th>Code</th> <th>Description</th> <th>Qty</th> <th>UOM</th> </tr> </thead> <tbody> <tr> <td>MOV0013A0</td> <td>HOOD RING GASKET GN1110A2</td> <td>0.100</td> <td>PZ</td> </tr> <tr> <td>VE1095A0</td> <td>GE 25A 230V REMOTE CONTROL SWITCH</td> <td>1</td> <td>PZ</td> </tr> <tr> <td>VM1075A1</td> <td>PLASTIC CLIP TO FIX CONTACTORS</td> <td>4</td> <td>PZ</td> </tr> <tr> <td>VM1224A0</td> <td>65MY 220MM 2 COLOURS SHRINK TUBE</td> <td>0.250</td> <td>M</td> </tr> </tbody> </table>	Code	Description	Qty	UOM	MOV0013A0	HOOD RING GASKET GN1110A2	0.100	PZ	VE1095A0	GE 25A 230V REMOTE CONTROL SWITCH	1	PZ	VM1075A1	PLASTIC CLIP TO FIX CONTACTORS	4	PZ	VM1224A0	65MY 220MM 2 COLOURS SHRINK TUBE	0.250	M
					Code	Description	Qty	UOM																	
					MOV0013A0	HOOD RING GASKET GN1110A2	0.100	PZ																	
					VE1095A0	GE 25A 230V REMOTE CONTROL SWITCH	1	PZ																	
VM1075A1	PLASTIC CLIP TO FIX CONTACTORS	4	PZ																						
VM1224A0	65MY 220MM 2 COLOURS SHRINK TUBE	0.250	M																						
MR1011A	UL 125A GROUND TERMINAL		KMR1011A	UL 125A GROUND TERMINAL KIT	<table border="1"> <thead> <tr> <th>Code</th> <th>Description</th> <th>Qty</th> <th>UOM</th> </tr> </thead> <tbody> <tr> <td>MR1011A0</td> <td>UL 125A GROUND TERMINAL</td> <td>1</td> <td>PZ</td> </tr> <tr> <td>VM1224A0</td> <td>65MY 220MM 2 COLOURS SHRINK TUBE</td> <td>0.300</td> <td>M</td> </tr> </tbody> </table>	Code	Description	Qty	UOM	MR1011A0	UL 125A GROUND TERMINAL	1	PZ	VM1224A0	65MY 220MM 2 COLOURS SHRINK TUBE	0.300	M								
					Code	Description	Qty	UOM																	
MR1011A0	UL 125A GROUND TERMINAL	1	PZ																						
VM1224A0	65MY 220MM 2 COLOURS SHRINK TUBE	0.300	M																						
MR1010A	UNIPOLAR TERMINAL BOARD UL ERICO UDJ160A		KMR1010A	UNIPOLAR TERMINAL BOARD KIT	<table border="1"> <thead> <tr> <th>Code</th> <th>Description</th> <th>Qty</th> <th>UOM</th> </tr> </thead> <tbody> <tr> <td>MR1010A0</td> <td>UNIPOLAR TERMINAL BOARD UL ERICO UDJ160</td> <td>1</td> <td>PZ</td> </tr> <tr> <td>VM1224A0</td> <td>65MY 220MM 2 COLOURS SHRINK TUBE</td> <td>0.300</td> <td>M</td> </tr> </tbody> </table>	Code	Description	Qty	UOM	MR1010A0	UNIPOLAR TERMINAL BOARD UL ERICO UDJ160	1	PZ	VM1224A0	65MY 220MM 2 COLOURS SHRINK TUBE	0.300	M								
					Code	Description	Qty	UOM																	
MR1010A0	UNIPOLAR TERMINAL BOARD UL ERICO UDJ160	1	PZ																						
VM1224A0	65MY 220MM 2 COLOURS SHRINK TUBE	0.300	M																						
0H2053A			0H2053A0																						



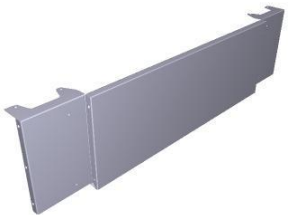

ASM2415C/0.D00 - Door





ASM2415C/0.D00 - Door

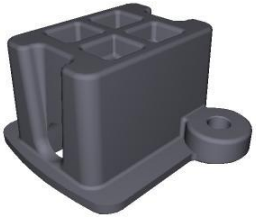

COMPONENT			SPARE PART																		
Code	Description	Image	Code	Description	Components list																
LP1029A	L=1199 S6 NO LED LIGHT BAR COVER		KLP1029A	L119 MM NO LED LIGHT HOLDER KIT	<table border="1"> <thead> <tr> <th>Code</th> <th>Description</th> <th>Qty</th> <th>UOM</th> </tr> </thead> <tbody> <tr> <td>IP1385A1</td> <td>CORNER POLYSTYREN E PACKING 110X80X2000</td> <td>2.540</td> <td>M</td> </tr> <tr> <td>LP1029A0</td> <td>L=1199 S6 NO LED LIGHT BAR COVER</td> <td>1</td> <td>PZ</td> </tr> <tr> <td>VM1059A1</td> <td>HEAT SHRINK FILM H800</td> <td>2.540</td> <td>M</td> </tr> </tbody> </table>	Code	Description	Qty	UOM	IP1385A1	CORNER POLYSTYREN E PACKING 110X80X2000	2.540	M	LP1029A0	L=1199 S6 NO LED LIGHT BAR COVER	1	PZ	VM1059A1	HEAT SHRINK FILM H800	2.540	M
Code	Description	Qty	UOM																		
IP1385A1	CORNER POLYSTYREN E PACKING 110X80X2000	2.540	M																		
LP1029A0	L=1199 S6 NO LED LIGHT BAR COVER	1	PZ																		
VM1059A1	HEAT SHRINK FILM H800	2.540	M																		
0B1344A	XEVL BIG DOOR FRONT LOWER PLATE		0B1344A0	XEVL BIG DOOR FRONT LOWER PLATE																	
0B1383A	XEVL BIG DOOR UPPER COVER PLAT		0B1383A0	XEVL BIG DOOR UPPER COVER PLAT																	
0H1996A	BIG DOOR-TROLLEY PUSHING CAM PLAT		0H1996A0	BIG DOOR-TROLLEY PUSHING CAM PLAT																	
VM2555A	BIG OVEN RIGHT DOOR GROOVED LOWER CAP		VM2555A0	BIG OVEN RIGHT DOOR GROOVED LOWER CAP																	

COMPONENT			SPARE PART		
Code	Description	Image	Code	Description	Components list
VI1930A	ST. STEEL 5X20 CHIP SCREW		VI1930A1	ST. STEEL 5X20 CHIP SCREW	
VM1326A	BIG DOOR LOWER ROLLER PIN		KVM1326A	BIG DOOR LOWER ROLLER + PIN KIT	
VM1332A	BIG DOOR LOWER ROLLER		KVM1326A	BIG DOOR LOWER ROLLER + PIN KIT	
VM2557A	BIG - DOOR LOWER CAP ROLLERWHEEL SUPPORT		VM2557A0	BIG - DOOR LOWER CAP ROLLERWHEEL SUPPORT	
VI1930A	ST. STEEL 5X20 CHIP SCREW		VI1930A1	ST. STEEL 5X20 CHIP SCREW	

COMPONENT			SPARE PART		
Code	Description	Image	Code	Description	Components list
TB3334A	UPPER DOOR CROSS TUBE		TB3334A0	UPPER DOOR CROSS TUBE	
ML1013A	BIG TROLLEY GASKET FLIPPER LEFT SPRING		ML1013A0	BIG TROLLEY GASKET FLIPPER LEFT SPRING	
ML1014A	BIG TROLLEY GASKET FLIPPER RIGHT SPRING		ML1014A0	BIG TROLLEY GASKET FLIPPER RIGHT SPRING	
VM1297A	BIG GASKET PLATE PUSHER		VM1297A0	BIG GASKET PLATE PUSHER	
VM1298A	TROLLEY GASKET PUSHER LEFT SUPPORT		VM1298A0	TROLLEY GASKET PUSHER LEFT SUPPORT	

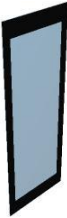
COMPONENT			SPARE PART																																										
Code	Description	Image	Code	Description	Components list																																								
VM1299A	RIGHT SUPPORT GASKET BIG		VM1299A0	RIGHT SUPPORT GASKET BIG																																									
VI1930A	ST. STEEL 5X20 CHIP SCREW		VI1930A1	ST. STEEL 5X20 CHIP SCREW																																									
VT1341A	XEVL BIG S. EXTERNAL GLASS		KVT1341A	BIG-L EXTERNAL GLASS KIT	<table border="1"> <thead> <tr> <th>Code</th> <th>Description</th> <th>Qty</th> <th>UOM</th> </tr> </thead> <tbody> <tr> <td>OB1340A0</td> <td>XEVL BIG EXTERNAL GLASS SUPPORT PROFILE</td> <td>2</td> <td>PZ</td> </tr> <tr> <td>ED1090A0</td> <td>COATED WHITE LABEL 100X45</td> <td>1</td> <td>PZ</td> </tr> <tr> <td>IL1050B0</td> <td>WOODEN PALLET 965X875X123</td> <td>1</td> <td>PZ</td> </tr> <tr> <td>IP1385A1</td> <td>CORNER POLYSTYREN E PACKING 110X80X2000</td> <td>2.500</td> <td>M</td> </tr> <tr> <td>IP1508A1</td> <td>POLYSTYREN E U SHAPED PROFILE 2000X60X60</td> <td>2</td> <td>M</td> </tr> <tr> <td>SL1155A1</td> <td>LOCTITE BICOMPONEN T SILICON</td> <td>300</td> <td>ML</td> </tr> <tr> <td>SL1156A0</td> <td>NOZZLE FOR SILICON GUN</td> <td>1</td> <td>PZ</td> </tr> <tr> <td>VM1059A1</td> <td>HEAT SHRINK FILM H800</td> <td>2</td> <td>M</td> </tr> <tr> <td>VT1341A0</td> <td>XEVL BIG S. EXTERNAL GLASS</td> <td>1</td> <td>PZ</td> </tr> </tbody> </table>	Code	Description	Qty	UOM	OB1340A0	XEVL BIG EXTERNAL GLASS SUPPORT PROFILE	2	PZ	ED1090A0	COATED WHITE LABEL 100X45	1	PZ	IL1050B0	WOODEN PALLET 965X875X123	1	PZ	IP1385A1	CORNER POLYSTYREN E PACKING 110X80X2000	2.500	M	IP1508A1	POLYSTYREN E U SHAPED PROFILE 2000X60X60	2	M	SL1155A1	LOCTITE BICOMPONEN T SILICON	300	ML	SL1156A0	NOZZLE FOR SILICON GUN	1	PZ	VM1059A1	HEAT SHRINK FILM H800	2	M	VT1341A0	XEVL BIG S. EXTERNAL GLASS	1	PZ
Code	Description	Qty	UOM																																										
OB1340A0	XEVL BIG EXTERNAL GLASS SUPPORT PROFILE	2	PZ																																										
ED1090A0	COATED WHITE LABEL 100X45	1	PZ																																										
IL1050B0	WOODEN PALLET 965X875X123	1	PZ																																										
IP1385A1	CORNER POLYSTYREN E PACKING 110X80X2000	2.500	M																																										
IP1508A1	POLYSTYREN E U SHAPED PROFILE 2000X60X60	2	M																																										
SL1155A1	LOCTITE BICOMPONEN T SILICON	300	ML																																										
SL1156A0	NOZZLE FOR SILICON GUN	1	PZ																																										
VM1059A1	HEAT SHRINK FILM H800	2	M																																										
VT1341A0	XEVL BIG S. EXTERNAL GLASS	1	PZ																																										
			KDR1310A	BIG-L CHEFTOP DOOR KIT	<table border="1"> <thead> <tr> <th>Code</th> <th>Description</th> <th>Qty</th> <th>UOM</th> </tr> </thead> <tbody> <tr> <td>OB1335A0</td> <td></td> <td>1</td> <td>PZ</td> </tr> </tbody> </table>	Code	Description	Qty	UOM	OB1335A0		1	PZ																																
Code	Description	Qty	UOM																																										
OB1335A0		1	PZ																																										







COMPONENT			SPARE PART																																																																														
Code	Description	Image	Code	Description	Components list																																																																												
VT1341A	XEVL BIG S. EXTERNAL GLASS		KDR1310A	BIG-L CHEFTOP DOOR KIT	<table border="1"> <thead> <tr> <th>Code</th> <th>Description</th> <th>Qty</th> <th>UOM</th> </tr> </thead> <tbody> <tr> <td>0B1335B0</td> <td>XEVL BIG RIGHT DOOR LEFT EXT. COLUMN</td> <td>1</td> <td>PZ</td> </tr> <tr> <td>0B1336A0</td> <td>XEVL BIG RIGHT DOOR RIGHT EXT. COLUMN</td> <td>1</td> <td>PZ</td> </tr> <tr> <td>0B1338A0</td> <td>XEVL BIG RIGHT DOOR LEFT INNER COLUMN</td> <td>1</td> <td>PZ</td> </tr> <tr> <td>0B1339A0</td> <td>XEVL BIG RIGHT DOOR RIGHT INNER COLUMN</td> <td>1</td> <td>PZ</td> </tr> <tr> <td>0B1340A0</td> <td>XEVL BIG EXTERNAL GLASS SUPPORT PROFILE</td> <td>2</td> <td>PZ</td> </tr> <tr> <td>0B1344A0</td> <td>XEVL BIG DOOR FRONT LOWER PLATE</td> <td>1</td> <td>PZ</td> </tr> <tr> <td>0B1383A0</td> <td>XEVL BIG DOOR UPPER COVER PLATE</td> <td>1</td> <td>PZ</td> </tr> <tr> <td>0B1390A0</td> <td></td> <td>1</td> <td>PZ</td> </tr> <tr> <td>0H1989A0</td> <td>BIG INNER DOUBLE GLASS LOCKING CLIP</td> <td>2</td> <td>PZ</td> </tr> <tr> <td>0H1996A0</td> <td>BIG DOOR-TROLL EY PUSHING CAM PLATE</td> <td>1</td> <td>PZ</td> </tr> <tr> <td>0H8033A0</td> <td>BIG HANDLE FIXING WASHER</td> <td>1</td> <td>PZ</td> </tr> <tr> <td>ED1240A0</td> <td>TECHNICAL DATA LABEL</td> <td>1</td> <td>PZ</td> </tr> <tr> <td>IP1508A1</td> <td>POLYSTYREN E U SHAPED PROFILE 2000X60X60</td> <td>4</td> <td>M</td> </tr> <tr> <td>LP1016A0</td> <td>E1199 L1000 LED BAR KIT</td> <td>1</td> <td>PZ</td> </tr> <tr> <td>LP1029A0</td> <td>L=1199 S6 NO LED LIGHT BAR COVER</td> <td>1</td> <td>PZ</td> </tr> <tr> <td>MG1095A1</td> <td></td> <td>1</td> <td>PZ</td> </tr> <tr> <td>MG1095A2</td> <td></td> <td>1</td> <td>PZ</td> </tr> <tr> <td>MG1095A3</td> <td></td> <td>1</td> <td>PZ</td> </tr> </tbody> </table>	Code	Description	Qty	UOM	0B1335B0	XEVL BIG RIGHT DOOR LEFT EXT. COLUMN	1	PZ	0B1336A0	XEVL BIG RIGHT DOOR RIGHT EXT. COLUMN	1	PZ	0B1338A0	XEVL BIG RIGHT DOOR LEFT INNER COLUMN	1	PZ	0B1339A0	XEVL BIG RIGHT DOOR RIGHT INNER COLUMN	1	PZ	0B1340A0	XEVL BIG EXTERNAL GLASS SUPPORT PROFILE	2	PZ	0B1344A0	XEVL BIG DOOR FRONT LOWER PLATE	1	PZ	0B1383A0	XEVL BIG DOOR UPPER COVER PLATE	1	PZ	0B1390A0		1	PZ	0H1989A0	BIG INNER DOUBLE GLASS LOCKING CLIP	2	PZ	0H1996A0	BIG DOOR-TROLL EY PUSHING CAM PLATE	1	PZ	0H8033A0	BIG HANDLE FIXING WASHER	1	PZ	ED1240A0	TECHNICAL DATA LABEL	1	PZ	IP1508A1	POLYSTYREN E U SHAPED PROFILE 2000X60X60	4	M	LP1016A0	E1199 L1000 LED BAR KIT	1	PZ	LP1029A0	L=1199 S6 NO LED LIGHT BAR COVER	1	PZ	MG1095A1		1	PZ	MG1095A2		1	PZ	MG1095A3		1	PZ
Code	Description	Qty	UOM																																																																														
0B1335B0	XEVL BIG RIGHT DOOR LEFT EXT. COLUMN	1	PZ																																																																														
0B1336A0	XEVL BIG RIGHT DOOR RIGHT EXT. COLUMN	1	PZ																																																																														
0B1338A0	XEVL BIG RIGHT DOOR LEFT INNER COLUMN	1	PZ																																																																														
0B1339A0	XEVL BIG RIGHT DOOR RIGHT INNER COLUMN	1	PZ																																																																														
0B1340A0	XEVL BIG EXTERNAL GLASS SUPPORT PROFILE	2	PZ																																																																														
0B1344A0	XEVL BIG DOOR FRONT LOWER PLATE	1	PZ																																																																														
0B1383A0	XEVL BIG DOOR UPPER COVER PLATE	1	PZ																																																																														
0B1390A0		1	PZ																																																																														
0H1989A0	BIG INNER DOUBLE GLASS LOCKING CLIP	2	PZ																																																																														
0H1996A0	BIG DOOR-TROLL EY PUSHING CAM PLATE	1	PZ																																																																														
0H8033A0	BIG HANDLE FIXING WASHER	1	PZ																																																																														
ED1240A0	TECHNICAL DATA LABEL	1	PZ																																																																														
IP1508A1	POLYSTYREN E U SHAPED PROFILE 2000X60X60	4	M																																																																														
LP1016A0	E1199 L1000 LED BAR KIT	1	PZ																																																																														
LP1029A0	L=1199 S6 NO LED LIGHT BAR COVER	1	PZ																																																																														
MG1095A1		1	PZ																																																																														
MG1095A2		1	PZ																																																																														
MG1095A3		1	PZ																																																																														

COMPONENT			SPARE PART																																																																																		
Code	Description	Image	Code	Description	Components list																																																																																
VT1341A	XEVL BIG S. EXTERNAL GLASS		KDR1310A	BIG-L CHEFTOP DOOR KIT	<table border="1"> <thead> <tr> <th>Code</th> <th>Description</th> <th>Qty</th> <th>UOM</th> </tr> </thead> <tbody> <tr> <td>MG1095A4</td> <td>BIG RIGHT SLAM DOOR HANDLE</td> <td>1</td> <td>PZ</td> </tr> <tr> <td>ML1013A0</td> <td>BIG TROLLEY GASKET FLIPPER LEFT SPRING</td> <td>2</td> <td>PZ</td> </tr> <tr> <td>ML1014A0</td> <td>BIG TROLLEY GASKET FLIPPER RIGHT SPRIN</td> <td>2</td> <td>PZ</td> </tr> <tr> <td>TB3334A0</td> <td>UPPER DOOR CROSS TUBE</td> <td>1</td> <td>PZ</td> </tr> <tr> <td>TB3337A0</td> <td></td> <td>1</td> <td>PZ</td> </tr> <tr> <td>VE1550A0</td> <td>5X3 MM NEODYMIUM MAGNET</td> <td>2</td> <td>PZ</td> </tr> <tr> <td>VI1014A0</td> <td>STAINLESS STEEL WASHER 4.5X9X0.8</td> <td>4</td> <td>PZ</td> </tr> <tr> <td>VI1074A0</td> <td>4X16 SCREW FOR PLASTIC</td> <td>14</td> <td>PZ</td> </tr> <tr> <td>VI1101A0</td> <td>M5X20 TSP-EI ST.STEEL DIN 7991 SCREW</td> <td>1</td> <td>PZ</td> </tr> <tr> <td>VI1220A1</td> <td>4,2X12 TCB SELF-TAPPIN G SCREW</td> <td>58</td> <td>PZ</td> </tr> <tr> <td>VI1300A0</td> <td>SCREW M6X12 T1/2T+INOX</td> <td>14</td> <td>PZ</td> </tr> <tr> <td>VI1310A0</td> <td>ZINC THREAD INSERT M6 FTR/E</td> <td>14</td> <td>PZ</td> </tr> <tr> <td>VI1930A0</td> <td>5X25 ST. STEEL SCREW CHIP</td> <td>16</td> <td>PZ</td> </tr> <tr> <td>VM1059A1</td> <td>HEAT SHRINK FILM H800</td> <td>4</td> <td>M</td> </tr> <tr> <td>VM1297A0</td> <td>BIG GASKET PLATE PUSHE</td> <td>2</td> <td>PZ</td> </tr> <tr> <td>VM1298A0</td> <td>TROLLEY GASKET PUSHER LEFT SUPPORT</td> <td>2</td> <td>PZ</td> </tr> <tr> <td>VM1299A0</td> <td>RIGHT SUPPORT GASKET BIG</td> <td>2</td> <td>PZ</td> </tr> <tr> <td>VM1326A0</td> <td>BIG DOOR LOWER ROLLER PIN</td> <td>1</td> <td>PZ</td> </tr> <tr> <td>VM1327A0</td> <td>BIG DOOR SIDE LOCKING PIN</td> <td>1</td> <td>PZ</td> </tr> </tbody> </table>	Code	Description	Qty	UOM	MG1095A4	BIG RIGHT SLAM DOOR HANDLE	1	PZ	ML1013A0	BIG TROLLEY GASKET FLIPPER LEFT SPRING	2	PZ	ML1014A0	BIG TROLLEY GASKET FLIPPER RIGHT SPRIN	2	PZ	TB3334A0	UPPER DOOR CROSS TUBE	1	PZ	TB3337A0		1	PZ	VE1550A0	5X3 MM NEODYMIUM MAGNET	2	PZ	VI1014A0	STAINLESS STEEL WASHER 4.5X9X0.8	4	PZ	VI1074A0	4X16 SCREW FOR PLASTIC	14	PZ	VI1101A0	M5X20 TSP-EI ST.STEEL DIN 7991 SCREW	1	PZ	VI1220A1	4,2X12 TCB SELF-TAPPIN G SCREW	58	PZ	VI1300A0	SCREW M6X12 T1/2T+INOX	14	PZ	VI1310A0	ZINC THREAD INSERT M6 FTR/E	14	PZ	VI1930A0	5X25 ST. STEEL SCREW CHIP	16	PZ	VM1059A1	HEAT SHRINK FILM H800	4	M	VM1297A0	BIG GASKET PLATE PUSHE	2	PZ	VM1298A0	TROLLEY GASKET PUSHER LEFT SUPPORT	2	PZ	VM1299A0	RIGHT SUPPORT GASKET BIG	2	PZ	VM1326A0	BIG DOOR LOWER ROLLER PIN	1	PZ	VM1327A0	BIG DOOR SIDE LOCKING PIN	1	PZ
Code	Description	Qty	UOM																																																																																		
MG1095A4	BIG RIGHT SLAM DOOR HANDLE	1	PZ																																																																																		
ML1013A0	BIG TROLLEY GASKET FLIPPER LEFT SPRING	2	PZ																																																																																		
ML1014A0	BIG TROLLEY GASKET FLIPPER RIGHT SPRIN	2	PZ																																																																																		
TB3334A0	UPPER DOOR CROSS TUBE	1	PZ																																																																																		
TB3337A0		1	PZ																																																																																		
VE1550A0	5X3 MM NEODYMIUM MAGNET	2	PZ																																																																																		
VI1014A0	STAINLESS STEEL WASHER 4.5X9X0.8	4	PZ																																																																																		
VI1074A0	4X16 SCREW FOR PLASTIC	14	PZ																																																																																		
VI1101A0	M5X20 TSP-EI ST.STEEL DIN 7991 SCREW	1	PZ																																																																																		
VI1220A1	4,2X12 TCB SELF-TAPPIN G SCREW	58	PZ																																																																																		
VI1300A0	SCREW M6X12 T1/2T+INOX	14	PZ																																																																																		
VI1310A0	ZINC THREAD INSERT M6 FTR/E	14	PZ																																																																																		
VI1930A0	5X25 ST. STEEL SCREW CHIP	16	PZ																																																																																		
VM1059A1	HEAT SHRINK FILM H800	4	M																																																																																		
VM1297A0	BIG GASKET PLATE PUSHE	2	PZ																																																																																		
VM1298A0	TROLLEY GASKET PUSHER LEFT SUPPORT	2	PZ																																																																																		
VM1299A0	RIGHT SUPPORT GASKET BIG	2	PZ																																																																																		
VM1326A0	BIG DOOR LOWER ROLLER PIN	1	PZ																																																																																		
VM1327A0	BIG DOOR SIDE LOCKING PIN	1	PZ																																																																																		



COMPONENT			SPARE PART																																																																							
Code	Description	Image	Code	Description	Components list																																																																					
VT1341A	XEVL BIG S. EXTERNAL GLASS		KDR1310A	BIG-L CHEFTOP DOOR KIT	<table border="1"> <thead> <tr> <th>Code</th> <th>Description</th> <th>Qty</th> <th>UOM</th> </tr> </thead> <tbody> <tr> <td>VM1332A0</td> <td>BIG DOOR LOWER ROLLE</td> <td>1</td> <td>PZ</td> </tr> <tr> <td>VM1379A0</td> <td>BIG TROLLEY GASKET BUSHING PAD</td> <td>3</td> <td>PZ</td> </tr> <tr> <td>VM1631A0</td> <td>PLUS INNER GLASS PUSHING CAP</td> <td>8</td> <td>PZ</td> </tr> <tr> <td>VM2550A0</td> <td>BIG DOOR LEFT UPPER CAP</td> <td>1</td> <td>PZ</td> </tr> <tr> <td>VM2550A1</td> <td>BIG DOOR LEFT UPPER CAP</td> <td>1</td> <td>PZ</td> </tr> <tr> <td>VM2551A0</td> <td>BIG RIGHT UPPER DOOR CAP</td> <td>1</td> <td>PZ</td> </tr> <tr> <td>VM2551A1</td> <td>BIG DOOR RIGHT UPPER CAP</td> <td>1</td> <td>PZ</td> </tr> <tr> <td>VM2552A0</td> <td>BIG DOOR LEFT LOWER CAP</td> <td>1</td> <td>PZ</td> </tr> <tr> <td>VM2553A0</td> <td>BIG DOOR RIGHT LOWER CAP</td> <td>1</td> <td>PZ</td> </tr> <tr> <td>VM2554A0</td> <td>BIG OVEN DOOR FULCRUM UPPER BUSHING</td> <td>1</td> <td>PZ</td> </tr> <tr> <td>VM2555A0</td> <td>BIG OVEN RIGHT DOOR GROOVED LOWER CAP</td> <td>1</td> <td>PZ</td> </tr> <tr> <td>VM2557A0</td> <td>BIG - DOOR LOWER CAP ROLLERWHEEL L SUPPORT</td> <td>1</td> <td>PZ</td> </tr> <tr> <td>VM2570B0</td> <td>BIG 6+6 INTERNAL GLASS SUPPORT KIT</td> <td>8</td> <td>PZ</td> </tr> <tr> <td>VM2587B0</td> <td>BIG OVEN PUSH-TO-CLO SE RIGHT HANDLE PIN</td> <td>1</td> <td>PZ</td> </tr> <tr> <td>VM2615A0</td> <td>HANDLE FIXING COVER</td> <td>1</td> <td>PZ</td> </tr> <tr> <td>VT1341A0</td> <td>XEVL BIG S. EXTERNAL GLASS</td> <td></td> <td></td> <td></td> </tr> </tbody> </table>	Code	Description	Qty	UOM	VM1332A0	BIG DOOR LOWER ROLLE	1	PZ	VM1379A0	BIG TROLLEY GASKET BUSHING PAD	3	PZ	VM1631A0	PLUS INNER GLASS PUSHING CAP	8	PZ	VM2550A0	BIG DOOR LEFT UPPER CAP	1	PZ	VM2550A1	BIG DOOR LEFT UPPER CAP	1	PZ	VM2551A0	BIG RIGHT UPPER DOOR CAP	1	PZ	VM2551A1	BIG DOOR RIGHT UPPER CAP	1	PZ	VM2552A0	BIG DOOR LEFT LOWER CAP	1	PZ	VM2553A0	BIG DOOR RIGHT LOWER CAP	1	PZ	VM2554A0	BIG OVEN DOOR FULCRUM UPPER BUSHING	1	PZ	VM2555A0	BIG OVEN RIGHT DOOR GROOVED LOWER CAP	1	PZ	VM2557A0	BIG - DOOR LOWER CAP ROLLERWHEEL L SUPPORT	1	PZ	VM2570B0	BIG 6+6 INTERNAL GLASS SUPPORT KIT	8	PZ	VM2587B0	BIG OVEN PUSH-TO-CLO SE RIGHT HANDLE PIN	1	PZ	VM2615A0	HANDLE FIXING COVER	1	PZ	VT1341A0	XEVL BIG S. EXTERNAL GLASS			
Code	Description	Qty	UOM																																																																							
VM1332A0	BIG DOOR LOWER ROLLE	1	PZ																																																																							
VM1379A0	BIG TROLLEY GASKET BUSHING PAD	3	PZ																																																																							
VM1631A0	PLUS INNER GLASS PUSHING CAP	8	PZ																																																																							
VM2550A0	BIG DOOR LEFT UPPER CAP	1	PZ																																																																							
VM2550A1	BIG DOOR LEFT UPPER CAP	1	PZ																																																																							
VM2551A0	BIG RIGHT UPPER DOOR CAP	1	PZ																																																																							
VM2551A1	BIG DOOR RIGHT UPPER CAP	1	PZ																																																																							
VM2552A0	BIG DOOR LEFT LOWER CAP	1	PZ																																																																							
VM2553A0	BIG DOOR RIGHT LOWER CAP	1	PZ																																																																							
VM2554A0	BIG OVEN DOOR FULCRUM UPPER BUSHING	1	PZ																																																																							
VM2555A0	BIG OVEN RIGHT DOOR GROOVED LOWER CAP	1	PZ																																																																							
VM2557A0	BIG - DOOR LOWER CAP ROLLERWHEEL L SUPPORT	1	PZ																																																																							
VM2570B0	BIG 6+6 INTERNAL GLASS SUPPORT KIT	8	PZ																																																																							
VM2587B0	BIG OVEN PUSH-TO-CLO SE RIGHT HANDLE PIN	1	PZ																																																																							
VM2615A0	HANDLE FIXING COVER	1	PZ																																																																							
VT1341A0	XEVL BIG S. EXTERNAL GLASS																																																																									





COMPONENT			SPARE PART																						
Code	Description	Image	Code	Description	Components list																				
VN1179A	CONTROL BOARD 40X40X20MM 12V COOLING FAN		KVN1179A	CONTROL BOARD COOLING FAN KIT	<table border="1"> <thead> <tr> <th>Code</th> <th>Description</th> <th>Qty</th> <th>UOM</th> </tr> </thead> <tbody> <tr> <td>VM1224A0</td> <td>65MY 220MM 2 COLOURS SHRINK TUBE</td> <td>0.150</td> <td>M</td> </tr> <tr> <td>VN1179A0</td> <td>CONTROL BOARD 40X40X20MM 12V COOLING FAN</td> <td>1</td> <td>PZ</td> </tr> <tr> <td>VN1179A0</td> <td>CONTROL BOARD 40X40X20MM 12V COOLING FAN</td> <td>1</td> <td>PZ</td> </tr> <tr> <td>VN1179A1</td> <td>CONTROL BOARD 40X40X20MM 12V COOLING FAN</td> <td>1</td> <td>PZ</td> </tr> </tbody> </table>	Code	Description	Qty	UOM	VM1224A0	65MY 220MM 2 COLOURS SHRINK TUBE	0.150	M	VN1179A0	CONTROL BOARD 40X40X20MM 12V COOLING FAN	1	PZ	VN1179A0	CONTROL BOARD 40X40X20MM 12V COOLING FAN	1	PZ	VN1179A1	CONTROL BOARD 40X40X20MM 12V COOLING FAN	1	PZ
Code	Description	Qty	UOM																						
VM1224A0	65MY 220MM 2 COLOURS SHRINK TUBE	0.150	M																						
VN1179A0	CONTROL BOARD 40X40X20MM 12V COOLING FAN	1	PZ																						
VN1179A0	CONTROL BOARD 40X40X20MM 12V COOLING FAN	1	PZ																						
VN1179A1	CONTROL BOARD 40X40X20MM 12V COOLING FAN	1	PZ																						
VP1007A	20X20 H 20 BIG-L BOARD FAN SUPPORT		KVP1007A	20X20 H20 CONTROL BOARD FAN SUPPORT KIT																					
LP1016A	E1199 L1000 LED BAR KIT		LP1016A0	E1199 L1000 LED BAR KIT																					
VM1327A	BIG DOOR SIDE LOCKING PIN		KVM1327A	BIG DOOR SIDE LOCKING PIN KIT																					





COMPONENT			SPARE PART																		
Code	Description	Image	Code	Description	Components list																
VM2552A	BIG DOOR LEFT LOWER CAP		VM2552A0	BIG DOOR LEFT LOWER CAP																	
VM2553A	BIG DOOR RIGHT LOWER CAP		VM2553A0	BIG DOOR RIGHT LOWER CAP																	
VM2554A	BIG OVEN DOOR FULCRUM UPPER BUSHING		VM2554A0	BIG OVEN DOOR FULCRUM UPPER BUSHING																	
0H1989A	BIG INNER DOUBLE GLASS LOCKING CLIP		0H1989A0	BIG INNER DOUBLE GLASS LOCKING CLIP																	
PE1059A	MM USB-RESET SUPPORT		KPE1059A	MM USB-RESET SUPPORT KIT	<table border="1"> <thead> <tr> <th>Code</th> <th>Description</th> <th>Qty</th> <th>UOM</th> </tr> </thead> <tbody> <tr> <td>PE1059A0</td> <td>MM USB-RESET SUPPORT</td> <td>1</td> <td>PZ</td> </tr> <tr> <td>V11220A1</td> <td>4,2X12 TCB SELF-TAPPING SCREW</td> <td>2</td> <td>PZ</td> </tr> <tr> <td>VM2147A0</td> <td>410X343X15 MM PINK SMOOTH ESD SPONGE</td> <td>0.250</td> <td>PZ</td> </tr> </tbody> </table>	Code	Description	Qty	UOM	PE1059A0	MM USB-RESET SUPPORT	1	PZ	V11220A1	4,2X12 TCB SELF-TAPPING SCREW	2	PZ	VM2147A0	410X343X15 MM PINK SMOOTH ESD SPONGE	0.250	PZ
Code	Description	Qty	UOM																		
PE1059A0	MM USB-RESET SUPPORT	1	PZ																		
V11220A1	4,2X12 TCB SELF-TAPPING SCREW	2	PZ																		
VM2147A0	410X343X15 MM PINK SMOOTH ESD SPONGE	0.250	PZ																		



COMPONENT			SPARE PART														
Code	Description	Image	Code	Description	Components list												
VM2550A	BIG DOOR LEFT UPPER CAP		VM2550A1	BIG DOOR LEFT UPPER CAP													
VM2551A	BIG DOOR RIGHT UPPER CAP		VM2551A1	BIG DOOR RIGHT UPPER CAP													
VI1930A	ST. STEEL 5X20 CHIP SCREW		VI1930A1	ST. STEEL 5X20 CHIP SCREW													
0H3056A	DOUBLE GLASS CLIP SHIM		0H3056A0	DOUBLE GLASS CLIP SHIM													
VM1631A	PLUS INNER GLASS PUSHING CAP		KVM1631A	CAP FOR INTERNAL GLASS 10 PCS KIT	<table border="1"> <thead> <tr> <th>Code</th> <th>Description</th> <th>Qty</th> <th>UOM</th> </tr> </thead> <tbody> <tr> <td>VM1224A0</td> <td>65MY 220MM 2 COLOURS SHRINK TUBE</td> <td>0.200</td> <td>M</td> </tr> <tr> <td>VM1631A0</td> <td>PLUS INNER GLASS PUSHING CAP</td> <td>10</td> <td>PZ</td> </tr> </tbody> </table>	Code	Description	Qty	UOM	VM1224A0	65MY 220MM 2 COLOURS SHRINK TUBE	0.200	M	VM1631A0	PLUS INNER GLASS PUSHING CAP	10	PZ
Code	Description	Qty	UOM														
VM1224A0	65MY 220MM 2 COLOURS SHRINK TUBE	0.200	M														
VM1631A0	PLUS INNER GLASS PUSHING CAP	10	PZ														

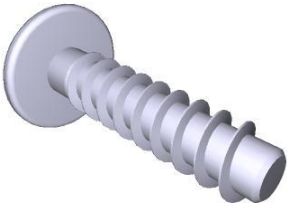

COMPONENT			SPARE PART																																														
Code	Description	Image	Code	Description	Components list																																												
VM2570C	XEVL INTERNAL GLASS CAP SUPPORT		KVM2570C	XEVL INTERNAL GLASS CAP SUPPORT 4PCS KIT																																													
VM1379B	XEVL BIG TROLLEY GASKET WASHER		KVM1376A	XF023-XF043 RIGHT DOOR COLUMN KIT	<table border="1"> <thead> <tr> <th>Code</th> <th>Description</th> <th>Qty</th> <th>UOM</th> </tr> </thead> <tbody> <tr> <td>0H3110A1</td> <td>GLASS HOLDING ST.STEEL UPPER PLATE</td> <td>1</td> <td>PZ</td> </tr> <tr> <td>0H3111A2</td> <td>GLASS HOLDING ST.STEEL LOWER PLATE</td> <td>1</td> <td>PZ</td> </tr> <tr> <td>GN1240A0</td> <td>COLUMN-GLA SS BLACK SILICON SEAL</td> <td>2</td> <td>PZ</td> </tr> <tr> <td>VI1865A0</td> <td>5X10 TCB+ SELF-THREADING SCREW</td> <td>1</td> <td>PZ</td> </tr> <tr> <td>VI1870A0</td> <td>50X50 SELF-THREADING SCREW FOR PLASTIC</td> <td>1</td> <td>PZ</td> </tr> <tr> <td>VM1376A0</td> <td>L. MICRO ANNA RIGHT DOOR COLUMN</td> <td>1</td> <td>PZ</td> </tr> <tr> <td>VM1376A1</td> <td>H381 LMC RIGHT DOOR COLUMN</td> <td>1</td> <td>PZ</td> </tr> <tr> <td>VM1380B0</td> <td>L.MICRO GLASS-DOOR FIXING CAP</td> <td>1</td> <td>PZ</td> </tr> <tr> <td>VM1794A0</td> <td>250X4.8 PA66 BLACK CLAMP</td> <td>2</td> <td>PZ</td> </tr> <tr> <td>VM2103A0</td> <td>CLAMP LOCK</td> <td>2</td> <td>PZ</td> </tr> </tbody> </table>	Code	Description	Qty	UOM	0H3110A1	GLASS HOLDING ST.STEEL UPPER PLATE	1	PZ	0H3111A2	GLASS HOLDING ST.STEEL LOWER PLATE	1	PZ	GN1240A0	COLUMN-GLA SS BLACK SILICON SEAL	2	PZ	VI1865A0	5X10 TCB+ SELF-THREADING SCREW	1	PZ	VI1870A0	50X50 SELF-THREADING SCREW FOR PLASTIC	1	PZ	VM1376A0	L. MICRO ANNA RIGHT DOOR COLUMN	1	PZ	VM1376A1	H381 LMC RIGHT DOOR COLUMN	1	PZ	VM1380B0	L.MICRO GLASS-DOOR FIXING CAP	1	PZ	VM1794A0	250X4.8 PA66 BLACK CLAMP	2	PZ	VM2103A0	CLAMP LOCK	2	PZ
Code	Description	Qty	UOM																																														
0H3110A1	GLASS HOLDING ST.STEEL UPPER PLATE	1	PZ																																														
0H3111A2	GLASS HOLDING ST.STEEL LOWER PLATE	1	PZ																																														
GN1240A0	COLUMN-GLA SS BLACK SILICON SEAL	2	PZ																																														
VI1865A0	5X10 TCB+ SELF-THREADING SCREW	1	PZ																																														
VI1870A0	50X50 SELF-THREADING SCREW FOR PLASTIC	1	PZ																																														
VM1376A0	L. MICRO ANNA RIGHT DOOR COLUMN	1	PZ																																														
VM1376A1	H381 LMC RIGHT DOOR COLUMN	1	PZ																																														
VM1380B0	L.MICRO GLASS-DOOR FIXING CAP	1	PZ																																														
VM1794A0	250X4.8 PA66 BLACK CLAMP	2	PZ																																														
VM2103A0	CLAMP LOCK	2	PZ																																														
TB3337B	XEVL BIG RIGHT DOOR LOWER CROSS TUBE		TB3337B0	XEVL BIG RIGHT DOOR LOWER CROSS TUBE																																													

COMPONENT			SPARE PART										
Code	Description	Image	Code	Description	Components list								
VI1074A	4X16 SCREW FOR PLASTIC		VI1074A0	4X16 SCREW FOR PLASTIC									
0B1390B	XEVL BIG RIGHT DOOR UPPER PROFILE		0B1390B0	XEVL BIG RIGHT DOOR UPPER PROFILE									
VI0515A	STAINLESS STEEL WASHER D=5 6592		VI0515A0	STAINLESS STEEL WASHER D=5 6592									
0H8010A	DOUBLE GLASS COUNTER BRACKET		0H8010A0	DOUBLE GLASS COUNTER BRACKET									
CR1109A	XEVL DOUBLE GLASS LOWER HINGE		KCR1109A	BIG DOUBLE GLASS LOWER HINGE KIT	<table border="1"> <thead> <tr> <th>Code</th> <th>Description</th> <th>Qty</th> <th>UOM</th> </tr> </thead> <tbody> <tr> <td>CR1109A0</td> <td>XEVL DOUBLE GLASS LOWER HINGE</td> <td>1</td> <td>PZ</td> </tr> </tbody> </table>	Code	Description	Qty	UOM	CR1109A0	XEVL DOUBLE GLASS LOWER HINGE	1	PZ
Code	Description	Qty	UOM										
CR1109A0	XEVL DOUBLE GLASS LOWER HINGE	1	PZ										



COMPONENT			SPARE PART																																																																										
Code	Description	Image	Code	Description	Components list																																																																								
VT1376A	BIG S. INTERNAL GLASS TH.6		KVT1379A	BIG-L INTERNAL GLASS KIT LEFT 2GLASSES	<table border="1"> <thead> <tr> <th>Code</th> <th>Description</th> <th>Qty</th> <th>UOM</th> </tr> </thead> <tbody> <tr> <td>0B1387A0</td> <td>XEVL BIG DOUBLE GLASS UPPER EXT. PROFILE</td> <td>1</td> <td>PZ</td> </tr> <tr> <td>0B1388A0</td> <td>XEVL BIG DOUBLE GLASS LAT. EXT. PROFILE</td> <td>2</td> <td>PZ</td> </tr> <tr> <td>0B1389A0</td> <td></td> <td>2</td> <td>PZ</td> </tr> <tr> <td>0B1389A1</td> <td></td> <td>1</td> <td>PZ</td> </tr> <tr> <td>0B1389A2</td> <td>XEVL BIG DOUBLE GLASS LOWER PLATE</td> <td>1</td> <td>PZ</td> </tr> <tr> <td>0B1391A0</td> <td>XEVL BIG DOUBLE GLASS UPPER PROFILE</td> <td>2</td> <td>PZ</td> </tr> <tr> <td>0B1392A0</td> <td>XEVL BIG DOUBLE GLASS LATERAL PROFILE</td> <td>4</td> <td>PZ</td> </tr> <tr> <td>0H8010A0</td> <td>DOUBLE GLASS COUNTER BRACKET</td> <td>3</td> <td>PZ</td> </tr> <tr> <td>CR1109A0</td> <td>XEVL DOUBLE GLASS LOWER HINGE</td> <td>1</td> <td>PZ</td> </tr> <tr> <td>CR1118A0</td> <td>XEVL DOUBLE GLASS LOWER HINGE</td> <td>1</td> <td>PZ</td> </tr> <tr> <td>ED1090A0</td> <td>COATED WHITE LABEL 100X45</td> <td>1</td> <td>PZ</td> </tr> <tr> <td>IL1050B0</td> <td>WOODEN PALLET 965X875X123</td> <td>2</td> <td>PZ</td> </tr> <tr> <td>IP1508A1</td> <td>POLYSTYREN E U SHAPED PROFILE 2000X60X60</td> <td>2</td> <td>M</td> </tr> <tr> <td>SL1170A1</td> <td>S57 BLACK SILICON - 310ML CARTRIDGE</td> <td>500</td> <td>ML</td> </tr> <tr> <td>VI0055A0</td> <td>ST.STEEL TCEI M5X12 SCREW</td> <td>5</td> <td>PZ</td> </tr> <tr> <td>VI1091A0</td> <td>ST.STEEL 4X12 RIVET</td> <td>2</td> <td>PZ</td> </tr> <tr> <td>VI1094A0</td> <td>ST. STEEL M5X15 STUD</td> <td>10</td> <td>PZ</td> </tr> </tbody> </table>	Code	Description	Qty	UOM	0B1387A0	XEVL BIG DOUBLE GLASS UPPER EXT. PROFILE	1	PZ	0B1388A0	XEVL BIG DOUBLE GLASS LAT. EXT. PROFILE	2	PZ	0B1389A0		2	PZ	0B1389A1		1	PZ	0B1389A2	XEVL BIG DOUBLE GLASS LOWER PLATE	1	PZ	0B1391A0	XEVL BIG DOUBLE GLASS UPPER PROFILE	2	PZ	0B1392A0	XEVL BIG DOUBLE GLASS LATERAL PROFILE	4	PZ	0H8010A0	DOUBLE GLASS COUNTER BRACKET	3	PZ	CR1109A0	XEVL DOUBLE GLASS LOWER HINGE	1	PZ	CR1118A0	XEVL DOUBLE GLASS LOWER HINGE	1	PZ	ED1090A0	COATED WHITE LABEL 100X45	1	PZ	IL1050B0	WOODEN PALLET 965X875X123	2	PZ	IP1508A1	POLYSTYREN E U SHAPED PROFILE 2000X60X60	2	M	SL1170A1	S57 BLACK SILICON - 310ML CARTRIDGE	500	ML	VI0055A0	ST.STEEL TCEI M5X12 SCREW	5	PZ	VI1091A0	ST.STEEL 4X12 RIVET	2	PZ	VI1094A0	ST. STEEL M5X15 STUD	10	PZ
Code	Description	Qty	UOM																																																																										
0B1387A0	XEVL BIG DOUBLE GLASS UPPER EXT. PROFILE	1	PZ																																																																										
0B1388A0	XEVL BIG DOUBLE GLASS LAT. EXT. PROFILE	2	PZ																																																																										
0B1389A0		2	PZ																																																																										
0B1389A1		1	PZ																																																																										
0B1389A2	XEVL BIG DOUBLE GLASS LOWER PLATE	1	PZ																																																																										
0B1391A0	XEVL BIG DOUBLE GLASS UPPER PROFILE	2	PZ																																																																										
0B1392A0	XEVL BIG DOUBLE GLASS LATERAL PROFILE	4	PZ																																																																										
0H8010A0	DOUBLE GLASS COUNTER BRACKET	3	PZ																																																																										
CR1109A0	XEVL DOUBLE GLASS LOWER HINGE	1	PZ																																																																										
CR1118A0	XEVL DOUBLE GLASS LOWER HINGE	1	PZ																																																																										
ED1090A0	COATED WHITE LABEL 100X45	1	PZ																																																																										
IL1050B0	WOODEN PALLET 965X875X123	2	PZ																																																																										
IP1508A1	POLYSTYREN E U SHAPED PROFILE 2000X60X60	2	M																																																																										
SL1170A1	S57 BLACK SILICON - 310ML CARTRIDGE	500	ML																																																																										
VI0055A0	ST.STEEL TCEI M5X12 SCREW	5	PZ																																																																										
VI1091A0	ST.STEEL 4X12 RIVET	2	PZ																																																																										
VI1094A0	ST. STEEL M5X15 STUD	10	PZ																																																																										



COMPONENT			SPARE PART																																																			
Code	Description	Image	Code	Description	Components list																																																	
VT1376A	BIG S. INTERNAL GLASS TH.6		KVT1379A	BIG-L INTERNAL GLASS KIT LEFT 2GLASSES	<table border="1"> <thead> <tr> <th>Code</th> <th>Description</th> <th>Qty</th> <th>UOM</th> </tr> </thead> <tbody> <tr> <td>VI1225A0</td> <td>STAINLESS STEEL STRUCTURE RIVET 4X10.1</td> <td>25</td> <td>PZ</td> </tr> <tr> <td>VM1059A1</td> <td>HEAT SHRINK FILM H800</td> <td>2</td> <td>M</td> </tr> <tr> <td>VT1376A0</td> <td>BIG S. INTERNAL GLASS TH.6</td> <td>1</td> <td>PZ</td> </tr> <tr> <td>VT1377A0</td> <td>BIG S. INTERNAL INTERMEDIAT E GLASS TH.6</td> <td>1</td> <td>PZ</td> </tr> </tbody> </table>	Code	Description	Qty	UOM	VI1225A0	STAINLESS STEEL STRUCTURE RIVET 4X10.1	25	PZ	VM1059A1	HEAT SHRINK FILM H800	2	M	VT1376A0	BIG S. INTERNAL GLASS TH.6	1	PZ	VT1377A0	BIG S. INTERNAL INTERMEDIAT E GLASS TH.6	1	PZ																													
			Code	Description	Qty	UOM																																																
VI1225A0	STAINLESS STEEL STRUCTURE RIVET 4X10.1	25	PZ																																																			
VM1059A1	HEAT SHRINK FILM H800	2	M																																																			
VT1376A0	BIG S. INTERNAL GLASS TH.6	1	PZ																																																			
VT1377A0	BIG S. INTERNAL INTERMEDIAT E GLASS TH.6	1	PZ																																																			
KVT1378A	BIG-L INTERNAL GLASS KIT 2GLASSES RIGHT	<table border="1"> <thead> <tr> <th>Code</th> <th>Description</th> <th>Qty</th> <th>UOM</th> </tr> </thead> <tbody> <tr> <td>0B1387A0</td> <td>XEVL BIG DOUBLE GLASS UPPER EXT. PROFILE</td> <td>1</td> <td>PZ</td> </tr> <tr> <td>0B1388A0</td> <td>XEVL BIG DOUBLE GLASS LAT. EXT. PROFILE</td> <td>2</td> <td>PZ</td> </tr> <tr> <td>0B1389A0</td> <td></td> <td>1</td> <td>PZ</td> </tr> <tr> <td>0B1389A1</td> <td></td> <td>1</td> <td>PZ</td> </tr> <tr> <td>0B1389A2</td> <td>XEVL BIG DOUBLE GLASS LOWER PLATE</td> <td>1</td> <td>PZ</td> </tr> <tr> <td>0B1391A0</td> <td>XEVL BIG DOUBLE GLASS UPPER PROFILE</td> <td>1</td> <td>PZ</td> </tr> <tr> <td>0B1392A0</td> <td>XEVL BIG DOUBLE GLASS LATERAL PROFILE</td> <td>2</td> <td>PZ</td> </tr> <tr> <td>0H8010A0</td> <td>DOUBLE GLASS COUNTER BRACKET</td> <td>2</td> <td>PZ</td> </tr> <tr> <td>CR1109A0</td> <td>XEVL DOUBLE GLASS LOWER HINGE</td> <td>1</td> <td>PZ</td> </tr> <tr> <td>CR1118A0</td> <td>XEVL DOUBLE GLASS LOWER HINGE</td> <td>1</td> <td>PZ</td> </tr> <tr> <td>ED1090A0</td> <td>COATED WHITE LABEL 100X45</td> <td>1</td> <td>PZ</td> </tr> <tr> <td>IL1050B0</td> <td>WOODEN PALLET 965X875X123</td> <td>2</td> <td>PZ</td> </tr> </tbody> </table>	Code	Description	Qty	UOM	0B1387A0	XEVL BIG DOUBLE GLASS UPPER EXT. PROFILE	1	PZ	0B1388A0	XEVL BIG DOUBLE GLASS LAT. EXT. PROFILE	2	PZ	0B1389A0		1	PZ	0B1389A1		1	PZ	0B1389A2	XEVL BIG DOUBLE GLASS LOWER PLATE	1	PZ	0B1391A0	XEVL BIG DOUBLE GLASS UPPER PROFILE	1	PZ	0B1392A0	XEVL BIG DOUBLE GLASS LATERAL PROFILE	2	PZ	0H8010A0	DOUBLE GLASS COUNTER BRACKET	2	PZ	CR1109A0	XEVL DOUBLE GLASS LOWER HINGE	1	PZ	CR1118A0	XEVL DOUBLE GLASS LOWER HINGE	1	PZ	ED1090A0	COATED WHITE LABEL 100X45	1	PZ	IL1050B0	WOODEN PALLET 965X875X123	2	PZ
Code	Description	Qty	UOM																																																			
0B1387A0	XEVL BIG DOUBLE GLASS UPPER EXT. PROFILE	1	PZ																																																			
0B1388A0	XEVL BIG DOUBLE GLASS LAT. EXT. PROFILE	2	PZ																																																			
0B1389A0		1	PZ																																																			
0B1389A1		1	PZ																																																			
0B1389A2	XEVL BIG DOUBLE GLASS LOWER PLATE	1	PZ																																																			
0B1391A0	XEVL BIG DOUBLE GLASS UPPER PROFILE	1	PZ																																																			
0B1392A0	XEVL BIG DOUBLE GLASS LATERAL PROFILE	2	PZ																																																			
0H8010A0	DOUBLE GLASS COUNTER BRACKET	2	PZ																																																			
CR1109A0	XEVL DOUBLE GLASS LOWER HINGE	1	PZ																																																			
CR1118A0	XEVL DOUBLE GLASS LOWER HINGE	1	PZ																																																			
ED1090A0	COATED WHITE LABEL 100X45	1	PZ																																																			
IL1050B0	WOODEN PALLET 965X875X123	2	PZ																																																			





COMPONENT			SPARE PART																																						
Code	Description	Image	Code	Description	Components list																																				
VT1376A	BIG S. INTERNAL GLASS TH.6		KVT1378A	BIG-L INTERNAL GLASS KIT 2GLASSES RIGHT	<table border="1"> <thead> <tr> <th>Code</th> <th>Description</th> <th>Qty</th> <th>UOM</th> </tr> </thead> <tbody> <tr> <td>IP1508A1</td> <td>POLYSTYREN E U SHAPED PROFILE 2000X60X60</td> <td>2</td> <td>M</td> </tr> <tr> <td>SL1170A1</td> <td>S57 BLACK SILICON - 310ML CARTRIDGE</td> <td>500</td> <td>ML</td> </tr> <tr> <td>VI0055A0</td> <td>ST.STEEL TCEI M5X12 SCREW</td> <td>5</td> <td>PZ</td> </tr> <tr> <td>VI1091A0</td> <td>ST.STEEL 4X12 RIVET</td> <td>1</td> <td>PZ</td> </tr> <tr> <td>VI1094A0</td> <td>ST. STEEL M5X15 STUD</td> <td>5</td> <td>PZ</td> </tr> <tr> <td>VI1225A0</td> <td>STAINLESS STEEL STRUCTURE RIVET 4X10.1</td> <td>19</td> <td>PZ</td> </tr> <tr> <td>VT1376A0</td> <td>BIG S. INTERNAL GLASS TH.6</td> <td>1</td> <td>PZ</td> </tr> <tr> <td>VT1377A0</td> <td>BIG S. INTERNAL INTERMEDIAT E GLASS TH.6</td> <td>1</td> <td>PZ</td> </tr> </tbody> </table>	Code	Description	Qty	UOM	IP1508A1	POLYSTYREN E U SHAPED PROFILE 2000X60X60	2	M	SL1170A1	S57 BLACK SILICON - 310ML CARTRIDGE	500	ML	VI0055A0	ST.STEEL TCEI M5X12 SCREW	5	PZ	VI1091A0	ST.STEEL 4X12 RIVET	1	PZ	VI1094A0	ST. STEEL M5X15 STUD	5	PZ	VI1225A0	STAINLESS STEEL STRUCTURE RIVET 4X10.1	19	PZ	VT1376A0	BIG S. INTERNAL GLASS TH.6	1	PZ	VT1377A0	BIG S. INTERNAL INTERMEDIAT E GLASS TH.6	1	PZ
Code	Description	Qty	UOM																																						
IP1508A1	POLYSTYREN E U SHAPED PROFILE 2000X60X60	2	M																																						
SL1170A1	S57 BLACK SILICON - 310ML CARTRIDGE	500	ML																																						
VI0055A0	ST.STEEL TCEI M5X12 SCREW	5	PZ																																						
VI1091A0	ST.STEEL 4X12 RIVET	1	PZ																																						
VI1094A0	ST. STEEL M5X15 STUD	5	PZ																																						
VI1225A0	STAINLESS STEEL STRUCTURE RIVET 4X10.1	19	PZ																																						
VT1376A0	BIG S. INTERNAL GLASS TH.6	1	PZ																																						
VT1377A0	BIG S. INTERNAL INTERMEDIAT E GLASS TH.6	1	PZ																																						
VT1377A	BIG S. INTERNAL INTERMEDIATE GLASS TH.6		KVT1379A	BIG-L INTERNAL GLASS KIT LEFT 2GLASSES	<table border="1"> <thead> <tr> <th>Code</th> <th>Description</th> <th>Qty</th> <th>UOM</th> </tr> </thead> <tbody> <tr> <td>OB1387A0</td> <td>XEVL BIG DOUBLE GLASS UPPER EXT. PROFILE</td> <td>1</td> <td>PZ</td> </tr> <tr> <td>OB1388A0</td> <td>XEVL BIG DOUBLE GLASS LAT. EXT. PROFILE</td> <td>2</td> <td>PZ</td> </tr> <tr> <td>OB1389A0</td> <td></td> <td>2</td> <td>PZ</td> </tr> <tr> <td>OB1389A1</td> <td></td> <td>1</td> <td>PZ</td> </tr> <tr> <td>OB1389A2</td> <td>XEVL BIG DOUBLE GLASS LOWER PLATE</td> <td>1</td> <td>PZ</td> </tr> <tr> <td>OB1391A0</td> <td>XEVL BIG DOUBLE GLASS UPPER PROFILE</td> <td>2</td> <td>PZ</td> </tr> <tr> <td>OB1392A0</td> <td>XEVL BIG DOUBLE GLASS LATERAL PROFILE</td> <td>4</td> <td>PZ</td> </tr> <tr> <td>OH8010A0</td> <td>DOUBLE GLASS COUNTER BRACKET</td> <td>3</td> <td>PZ</td> </tr> </tbody> </table>	Code	Description	Qty	UOM	OB1387A0	XEVL BIG DOUBLE GLASS UPPER EXT. PROFILE	1	PZ	OB1388A0	XEVL BIG DOUBLE GLASS LAT. EXT. PROFILE	2	PZ	OB1389A0		2	PZ	OB1389A1		1	PZ	OB1389A2	XEVL BIG DOUBLE GLASS LOWER PLATE	1	PZ	OB1391A0	XEVL BIG DOUBLE GLASS UPPER PROFILE	2	PZ	OB1392A0	XEVL BIG DOUBLE GLASS LATERAL PROFILE	4	PZ	OH8010A0	DOUBLE GLASS COUNTER BRACKET	3	PZ
Code	Description	Qty	UOM																																						
OB1387A0	XEVL BIG DOUBLE GLASS UPPER EXT. PROFILE	1	PZ																																						
OB1388A0	XEVL BIG DOUBLE GLASS LAT. EXT. PROFILE	2	PZ																																						
OB1389A0		2	PZ																																						
OB1389A1		1	PZ																																						
OB1389A2	XEVL BIG DOUBLE GLASS LOWER PLATE	1	PZ																																						
OB1391A0	XEVL BIG DOUBLE GLASS UPPER PROFILE	2	PZ																																						
OB1392A0	XEVL BIG DOUBLE GLASS LATERAL PROFILE	4	PZ																																						
OH8010A0	DOUBLE GLASS COUNTER BRACKET	3	PZ																																						







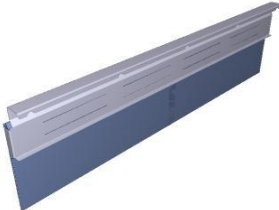
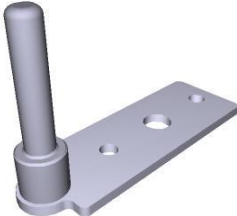

COMPONENT			SPARE PART																																																																																	
Code	Description	Image	Code	Description	Components list																																																																															
VT1377A	BIG S. INTERNAL INTERMEDIATE GLASS TH.6		KVT1379A	BIG-L INTERNAL GLASS KIT LEFT 2GLASSES	<table border="1"> <thead> <tr> <th>Code</th> <th>Description</th> <th>Qty</th> <th>UOM</th> </tr> </thead> <tbody> <tr> <td>CR1109A0</td> <td>XEVL DOUBLE GLASS LOWER HINGE</td> <td>1</td> <td>PZ</td> </tr> <tr> <td>CR1118A0</td> <td>XEVL DOUBLE GLASS LOWER HINGE</td> <td>1</td> <td>PZ</td> </tr> <tr> <td>ED1090A0</td> <td>COATED WHITE LABEL 100X45</td> <td>1</td> <td>PZ</td> </tr> <tr> <td>IL1050B0</td> <td>WOODEN PALLET 965X875X123</td> <td>2</td> <td>PZ</td> </tr> <tr> <td>IP1508A1</td> <td>POLYSTYREN E U SHAPED PROFILE 2000X60X60</td> <td>2</td> <td>M</td> </tr> <tr> <td>SL1170A1</td> <td>S57 BLACK SILICON - 310ML CARTRIDGE</td> <td>500</td> <td>ML</td> </tr> <tr> <td>VI0055A0</td> <td>ST.STEEL TCEI M5X12 SCREW</td> <td>5</td> <td>PZ</td> </tr> <tr> <td>VI1091A0</td> <td>ST.STEEL 4X12 RIVET</td> <td>2</td> <td>PZ</td> </tr> <tr> <td>VI1094A0</td> <td>ST. STEEL M5X15 STUD</td> <td>10</td> <td>PZ</td> </tr> <tr> <td>VI1225A0</td> <td>STAINLESS STEEL STRUCTURE RIVET 4X10.1</td> <td>25</td> <td>PZ</td> </tr> <tr> <td>VM1059A1</td> <td>HEAT SHRINK FILM H800</td> <td>2</td> <td>M</td> </tr> <tr> <td>VT1376A0</td> <td>BIG S. INTERNAL GLASS TH.6</td> <td>1</td> <td>PZ</td> </tr> <tr> <td>VT1377A0</td> <td>BIG S. INTERNAL INTERMEDIAT E GLASS TH.6</td> <td>1</td> <td>PZ</td> </tr> </tbody> </table>	Code	Description	Qty	UOM	CR1109A0	XEVL DOUBLE GLASS LOWER HINGE	1	PZ	CR1118A0	XEVL DOUBLE GLASS LOWER HINGE	1	PZ	ED1090A0	COATED WHITE LABEL 100X45	1	PZ	IL1050B0	WOODEN PALLET 965X875X123	2	PZ	IP1508A1	POLYSTYREN E U SHAPED PROFILE 2000X60X60	2	M	SL1170A1	S57 BLACK SILICON - 310ML CARTRIDGE	500	ML	VI0055A0	ST.STEEL TCEI M5X12 SCREW	5	PZ	VI1091A0	ST.STEEL 4X12 RIVET	2	PZ	VI1094A0	ST. STEEL M5X15 STUD	10	PZ	VI1225A0	STAINLESS STEEL STRUCTURE RIVET 4X10.1	25	PZ	VM1059A1	HEAT SHRINK FILM H800	2	M	VT1376A0	BIG S. INTERNAL GLASS TH.6	1	PZ	VT1377A0	BIG S. INTERNAL INTERMEDIAT E GLASS TH.6	1	PZ	KVT1378A	BIG-L INTERNAL GLASS KIT 2GLASSES RIGHT	<table border="1"> <thead> <tr> <th>Code</th> <th>Description</th> <th>Qty</th> <th>UOM</th> </tr> </thead> <tbody> <tr> <td>0B1387A0</td> <td>XEVL BIG DOUBLE GLASS UPPER EXT. PROFILE</td> <td>1</td> <td>PZ</td> </tr> <tr> <td>0B1388A0</td> <td>XEVL BIG DOUBLE GLASS LAT. EXT. PROFILE</td> <td>2</td> <td>PZ</td> </tr> <tr> <td>0B1389A0</td> <td></td> <td>1</td> <td>PZ</td> </tr> <tr> <td>0B1389A1</td> <td></td> <td>1</td> <td>PZ</td> </tr> </tbody> </table>	Code	Description	Qty	UOM	0B1387A0	XEVL BIG DOUBLE GLASS UPPER EXT. PROFILE	1	PZ	0B1388A0	XEVL BIG DOUBLE GLASS LAT. EXT. PROFILE	2	PZ	0B1389A0		1	PZ	0B1389A1		1	PZ
			Code	Description	Qty	UOM																																																																														
CR1109A0	XEVL DOUBLE GLASS LOWER HINGE	1	PZ																																																																																	
CR1118A0	XEVL DOUBLE GLASS LOWER HINGE	1	PZ																																																																																	
ED1090A0	COATED WHITE LABEL 100X45	1	PZ																																																																																	
IL1050B0	WOODEN PALLET 965X875X123	2	PZ																																																																																	
IP1508A1	POLYSTYREN E U SHAPED PROFILE 2000X60X60	2	M																																																																																	
SL1170A1	S57 BLACK SILICON - 310ML CARTRIDGE	500	ML																																																																																	
VI0055A0	ST.STEEL TCEI M5X12 SCREW	5	PZ																																																																																	
VI1091A0	ST.STEEL 4X12 RIVET	2	PZ																																																																																	
VI1094A0	ST. STEEL M5X15 STUD	10	PZ																																																																																	
VI1225A0	STAINLESS STEEL STRUCTURE RIVET 4X10.1	25	PZ																																																																																	
VM1059A1	HEAT SHRINK FILM H800	2	M																																																																																	
VT1376A0	BIG S. INTERNAL GLASS TH.6	1	PZ																																																																																	
VT1377A0	BIG S. INTERNAL INTERMEDIAT E GLASS TH.6	1	PZ																																																																																	
Code	Description	Qty	UOM																																																																																	
0B1387A0	XEVL BIG DOUBLE GLASS UPPER EXT. PROFILE	1	PZ																																																																																	
0B1388A0	XEVL BIG DOUBLE GLASS LAT. EXT. PROFILE	2	PZ																																																																																	
0B1389A0		1	PZ																																																																																	
0B1389A1		1	PZ																																																																																	

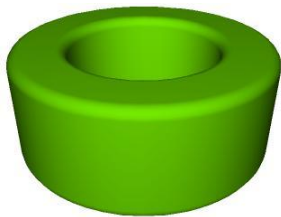

COMPONENT			SPARE PART																																																																						
Code	Description	Image	Code	Description	Components list																																																																				
VT1377A	BIG S. INTERNAL INTERMEDIATE GLASS TH.6		KVT1378A	BIG-L INTERNAL GLASS KIT 2GLASSES RIGHT	<table border="1"> <thead> <tr> <th>Code</th> <th>Description</th> <th>Qty</th> <th>UOM</th> </tr> </thead> <tbody> <tr> <td>0B1389A2</td> <td>XEVL BIG DOUBLE GLASS LOWER PLATE</td> <td>1</td> <td>PZ</td> </tr> <tr> <td>0B1391A0</td> <td>XEVL BIG DOUBLE GLASS UPPER PROFILE</td> <td>1</td> <td>PZ</td> </tr> <tr> <td>0B1392A0</td> <td>XEVL BIG DOUBLE GLASS LATERAL PROFILE</td> <td>2</td> <td>PZ</td> </tr> <tr> <td>0H8010A0</td> <td>DOUBLE GLASS COUNTER BRACKET</td> <td>2</td> <td>PZ</td> </tr> <tr> <td>CR1109A0</td> <td>XEVL DOUBLE GLASS LOWER HINGE</td> <td>1</td> <td>PZ</td> </tr> <tr> <td>CR1118A0</td> <td>XEVL DOUBLE GLASS LOWER HINGE</td> <td>1</td> <td>PZ</td> </tr> <tr> <td>ED1090A0</td> <td>COATED WHITE LABEL 100X45</td> <td>1</td> <td>PZ</td> </tr> <tr> <td>IL1050B0</td> <td>WOODEN PALLET 965X875X123</td> <td>2</td> <td>PZ</td> </tr> <tr> <td>IP1508A1</td> <td>POLYSTYREN E U SHAPED PROFILE 2000X60X60</td> <td>2</td> <td>M</td> </tr> <tr> <td>SL1170A1</td> <td>S57 BLACK SILICON - 310ML CARTRIDGE</td> <td>500</td> <td>ML</td> </tr> <tr> <td>VI0055A0</td> <td>ST.STEEL TCEI M5X12 SCREW</td> <td>5</td> <td>PZ</td> </tr> <tr> <td>VI1091A0</td> <td>ST.STEEL 4X12 RIVET</td> <td>1</td> <td>PZ</td> </tr> <tr> <td>VI1094A0</td> <td>ST. STEEL M5X15 STUD</td> <td>5</td> <td>PZ</td> </tr> <tr> <td>VI1225A0</td> <td>STAINLESS STEEL STRUCTURE RIVET 4X10.1</td> <td>19</td> <td>PZ</td> </tr> <tr> <td>VT1376A0</td> <td>BIG S. INTERNAL GLASS TH.6</td> <td>1</td> <td>PZ</td> </tr> <tr> <td>VT1377A0</td> <td>BIG S. INTERNAL INTERMEDIAT E GLASS TH.6</td> <td>1</td> <td>PZ</td> </tr> </tbody> </table>	Code	Description	Qty	UOM	0B1389A2	XEVL BIG DOUBLE GLASS LOWER PLATE	1	PZ	0B1391A0	XEVL BIG DOUBLE GLASS UPPER PROFILE	1	PZ	0B1392A0	XEVL BIG DOUBLE GLASS LATERAL PROFILE	2	PZ	0H8010A0	DOUBLE GLASS COUNTER BRACKET	2	PZ	CR1109A0	XEVL DOUBLE GLASS LOWER HINGE	1	PZ	CR1118A0	XEVL DOUBLE GLASS LOWER HINGE	1	PZ	ED1090A0	COATED WHITE LABEL 100X45	1	PZ	IL1050B0	WOODEN PALLET 965X875X123	2	PZ	IP1508A1	POLYSTYREN E U SHAPED PROFILE 2000X60X60	2	M	SL1170A1	S57 BLACK SILICON - 310ML CARTRIDGE	500	ML	VI0055A0	ST.STEEL TCEI M5X12 SCREW	5	PZ	VI1091A0	ST.STEEL 4X12 RIVET	1	PZ	VI1094A0	ST. STEEL M5X15 STUD	5	PZ	VI1225A0	STAINLESS STEEL STRUCTURE RIVET 4X10.1	19	PZ	VT1376A0	BIG S. INTERNAL GLASS TH.6	1	PZ	VT1377A0	BIG S. INTERNAL INTERMEDIAT E GLASS TH.6	1	PZ
Code	Description	Qty	UOM																																																																						
0B1389A2	XEVL BIG DOUBLE GLASS LOWER PLATE	1	PZ																																																																						
0B1391A0	XEVL BIG DOUBLE GLASS UPPER PROFILE	1	PZ																																																																						
0B1392A0	XEVL BIG DOUBLE GLASS LATERAL PROFILE	2	PZ																																																																						
0H8010A0	DOUBLE GLASS COUNTER BRACKET	2	PZ																																																																						
CR1109A0	XEVL DOUBLE GLASS LOWER HINGE	1	PZ																																																																						
CR1118A0	XEVL DOUBLE GLASS LOWER HINGE	1	PZ																																																																						
ED1090A0	COATED WHITE LABEL 100X45	1	PZ																																																																						
IL1050B0	WOODEN PALLET 965X875X123	2	PZ																																																																						
IP1508A1	POLYSTYREN E U SHAPED PROFILE 2000X60X60	2	M																																																																						
SL1170A1	S57 BLACK SILICON - 310ML CARTRIDGE	500	ML																																																																						
VI0055A0	ST.STEEL TCEI M5X12 SCREW	5	PZ																																																																						
VI1091A0	ST.STEEL 4X12 RIVET	1	PZ																																																																						
VI1094A0	ST. STEEL M5X15 STUD	5	PZ																																																																						
VI1225A0	STAINLESS STEEL STRUCTURE RIVET 4X10.1	19	PZ																																																																						
VT1376A0	BIG S. INTERNAL GLASS TH.6	1	PZ																																																																						
VT1377A0	BIG S. INTERNAL INTERMEDIAT E GLASS TH.6	1	PZ																																																																						

COMPONENT			SPARE PART																																																						
Code	Description	Image	Code	Description	Components list																																																				
0H8010A	DOUBLE GLASS COUNTER BRACKET		0H8010A0	DOUBLE GLASS COUNTER BRACKET																																																					
GN1690A	XEVL BIG DOOR-TROLLEY SINGLE GASKET SE		KG1678A	BIG-L TROLLEY DOOR GASKET KIT	<table border="1"> <thead> <tr> <th>Code</th> <th>Description</th> <th>Qty</th> <th>UOM</th> </tr> </thead> <tbody> <tr> <td>0B1345A0</td> <td></td> <td>1</td> <td>PZ</td> </tr> <tr> <td>0B1345A1</td> <td>XEVL BIG TROLLEY GASKET BONDING PLATE</td> <td>1</td> <td>PZ</td> </tr> <tr> <td>GN1618A0</td> <td></td> <td>0.750</td> <td>M</td> </tr> <tr> <td>GN1619A0</td> <td></td> <td>1</td> <td>PZ</td> </tr> <tr> <td>GN1620A0</td> <td></td> <td>0.750</td> <td>M</td> </tr> <tr> <td>GN1621A0</td> <td></td> <td>1</td> <td>PZ</td> </tr> <tr> <td>GN1677A0</td> <td>XEVL DOOR-TROLL EY GASKET</td> <td>0.750</td> <td>M</td> </tr> <tr> <td>SL1170A1</td> <td>S57 BLACK SILICON - 310ML CARTRIDGE</td> <td>180</td> <td>ML</td> </tr> <tr> <td>TB2629A0</td> <td>XEVL DOOR-TROLL EY GASKET ROD</td> <td>2</td> <td>PZ</td> </tr> <tr> <td>VI0515A0</td> <td>STAINLESS STEEL WASHER D=5 6592</td> <td>5</td> <td>PZ</td> </tr> <tr> <td>VI1770A0</td> <td>STAINLESS STEEL NUT M5 H=5 CH=8</td> <td>5</td> <td>PZ</td> </tr> <tr> <td>VI1992A0</td> <td>ST STEEL WASHER M5X15</td> <td>5</td> <td>PZ</td> </tr> </tbody> </table>	Code	Description	Qty	UOM	0B1345A0		1	PZ	0B1345A1	XEVL BIG TROLLEY GASKET BONDING PLATE	1	PZ	GN1618A0		0.750	M	GN1619A0		1	PZ	GN1620A0		0.750	M	GN1621A0		1	PZ	GN1677A0	XEVL DOOR-TROLL EY GASKET	0.750	M	SL1170A1	S57 BLACK SILICON - 310ML CARTRIDGE	180	ML	TB2629A0	XEVL DOOR-TROLL EY GASKET ROD	2	PZ	VI0515A0	STAINLESS STEEL WASHER D=5 6592	5	PZ	VI1770A0	STAINLESS STEEL NUT M5 H=5 CH=8	5	PZ	VI1992A0	ST STEEL WASHER M5X15	5	PZ
Code	Description	Qty	UOM																																																						
0B1345A0		1	PZ																																																						
0B1345A1	XEVL BIG TROLLEY GASKET BONDING PLATE	1	PZ																																																						
GN1618A0		0.750	M																																																						
GN1619A0		1	PZ																																																						
GN1620A0		0.750	M																																																						
GN1621A0		1	PZ																																																						
GN1677A0	XEVL DOOR-TROLL EY GASKET	0.750	M																																																						
SL1170A1	S57 BLACK SILICON - 310ML CARTRIDGE	180	ML																																																						
TB2629A0	XEVL DOOR-TROLL EY GASKET ROD	2	PZ																																																						
VI0515A0	STAINLESS STEEL WASHER D=5 6592	5	PZ																																																						
VI1770A0	STAINLESS STEEL NUT M5 H=5 CH=8	5	PZ																																																						
VI1992A0	ST STEEL WASHER M5X15	5	PZ																																																						
CR1118A	XEVL DOUBLE GLASS LOWER HINGE		KCR1118A	BIG DOUBLE GLASS UPPER HINGE KIT	<table border="1"> <thead> <tr> <th>Code</th> <th>Description</th> <th>Qty</th> <th>UOM</th> </tr> </thead> <tbody> <tr> <td>CR1118A0</td> <td>XEVL DOUBLE GLASS LOWER HINGE</td> <td>1</td> <td>PZ</td> </tr> </tbody> </table>	Code	Description	Qty	UOM	CR1118A0	XEVL DOUBLE GLASS LOWER HINGE	1	PZ																																												
Code	Description	Qty	UOM																																																						
CR1118A0	XEVL DOUBLE GLASS LOWER HINGE	1	PZ																																																						

COMPONENT			SPARE PART																		
Code	Description	Image	Code	Description	Components list																
CE1285A	EMI ROUND FERRITE MOD.2643801502		CE1285A0	EMI ROUND FERRITE MOD.2643801502																	
CE1053B	MM MICROFIT LED BAR POWER SUPPLY CABLE		KCE1053B	LED BAR EXTENSION CABLE KIT	<table border="1"> <thead> <tr> <th>Code</th> <th>Description</th> <th>Qty</th> <th>UOM</th> </tr> </thead> <tbody> <tr> <td>CE1053B0</td> <td>MM MICROFIT LED BAR POWER SUPPLY CABL</td> <td>1</td> <td>PZ</td> </tr> </tbody> </table>	Code	Description	Qty	UOM	CE1053B0	MM MICROFIT LED BAR POWER SUPPLY CABL	1	PZ								
Code	Description	Qty	UOM																		
CE1053B0	MM MICROFIT LED BAR POWER SUPPLY CABL	1	PZ																		
CE1054A	CONTROL BOARD-USB CONNECTING CABLE L=150		KCE1054A	MM L150 CONTROL USB CONNECTION CABLE KIT	<table border="1"> <thead> <tr> <th>Code</th> <th>Description</th> <th>Qty</th> <th>UOM</th> </tr> </thead> <tbody> <tr> <td>CE1054A0</td> <td>CONTROL BOARD-USB CONNECTING CABLE L=150</td> <td>1</td> <td>PZ</td> </tr> <tr> <td>VM1224A0</td> <td>65MY 220MM 2 COLOURS SHRINK TUBE</td> <td>0.250</td> <td>M</td> </tr> </tbody> </table>	Code	Description	Qty	UOM	CE1054A0	CONTROL BOARD-USB CONNECTING CABLE L=150	1	PZ	VM1224A0	65MY 220MM 2 COLOURS SHRINK TUBE	0.250	M				
Code	Description	Qty	UOM																		
CE1054A0	CONTROL BOARD-USB CONNECTING CABLE L=150	1	PZ																		
VM1224A0	65MY 220MM 2 COLOURS SHRINK TUBE	0.250	M																		
VI1074A	4X16 SCREW FOR PLASTIC		VI1074A0	4X16 SCREW FOR PLASTIC																	
CE1097A	4M SIHF 4 POLES MICROFIT CANBUS		KCE1097A	4 POLES MICROFIT 4 METRES BUS CABLE KIT	<table border="1"> <thead> <tr> <th>Code</th> <th>Description</th> <th>Qty</th> <th>UOM</th> </tr> </thead> <tbody> <tr> <td>CE1097A0</td> <td>4M SIHF 4 POLES MICROFIT CANBUS</td> <td>1</td> <td>PZ</td> </tr> <tr> <td>CE1285A0</td> <td>EMI ROUND FERRITE MOD.26438015 02</td> <td>1</td> <td>PZ</td> </tr> <tr> <td>VM1224A0</td> <td>65MY 220MM 2 COLOURS SHRINK TUBE</td> <td>0.300</td> <td>M</td> </tr> </tbody> </table>	Code	Description	Qty	UOM	CE1097A0	4M SIHF 4 POLES MICROFIT CANBUS	1	PZ	CE1285A0	EMI ROUND FERRITE MOD.26438015 02	1	PZ	VM1224A0	65MY 220MM 2 COLOURS SHRINK TUBE	0.300	M
Code	Description	Qty	UOM																		
CE1097A0	4M SIHF 4 POLES MICROFIT CANBUS	1	PZ																		
CE1285A0	EMI ROUND FERRITE MOD.26438015 02	1	PZ																		
VM1224A0	65MY 220MM 2 COLOURS SHRINK TUBE	0.300	M																		

COMPONENT			SPARE PART																																														
Code	Description	Image	Code	Description	Components list																																												
PE1062A	MM PLUS BIG CAPACITIVE CONTROL PANEL		KPE1062A	MM PLUS BIG CAPACITIVE CONTROL BOARD KIT	<table border="1"> <thead> <tr> <th>Code</th> <th>Description</th> <th>Qty</th> <th>UOM</th> </tr> </thead> <tbody> <tr> <td>CE2007A0</td> <td>4PM-MINIFIT 4PF 100mm MICROFIT CABLE</td> <td>1</td> <td>PZ</td> </tr> <tr> <td>PE1062A0</td> <td>MM PLUS BIG CAPACITIVE CONTROL PANEL</td> <td>1</td> <td>PZ</td> </tr> <tr> <td>VI1074A0</td> <td>4X16 SCREW FOR PLASTIC</td> <td>2</td> <td>PZ</td> </tr> <tr> <td>VI1103A0</td> <td>40X12 TBSP SCREW FOR PLASTIC</td> <td>2</td> <td>PZ</td> </tr> <tr> <td>VM2147A0</td> <td>410X343X15 MM PINK SMOOTH ESD SPONGE</td> <td>1</td> <td>PZ</td> </tr> <tr> <td>VM2295A1</td> <td>MIND.MAPS TOUCH CONTROL STYLUS KIT</td> <td>1</td> <td>PZ</td> </tr> <tr> <td>VM2583A1</td> <td></td> <td>1</td> <td>PZ</td> </tr> <tr> <td>VP1005A0</td> <td>BIG-L DOOR CONTROL BOARD SUPPPORT</td> <td>1</td> <td>PZ</td> </tr> <tr> <td>VP1005B0</td> <td>70 MM BIG-L DOOR CONTROL SUPPORT</td> <td>1</td> <td>PZ</td> </tr> <tr> <td>VP1078A0</td> <td>MM CONTROL BOARD PARTITION FRAME</td> <td>1</td> <td>PZ</td> </tr> </tbody> </table>	Code	Description	Qty	UOM	CE2007A0	4PM-MINIFIT 4PF 100mm MICROFIT CABLE	1	PZ	PE1062A0	MM PLUS BIG CAPACITIVE CONTROL PANEL	1	PZ	VI1074A0	4X16 SCREW FOR PLASTIC	2	PZ	VI1103A0	40X12 TBSP SCREW FOR PLASTIC	2	PZ	VM2147A0	410X343X15 MM PINK SMOOTH ESD SPONGE	1	PZ	VM2295A1	MIND.MAPS TOUCH CONTROL STYLUS KIT	1	PZ	VM2583A1		1	PZ	VP1005A0	BIG-L DOOR CONTROL BOARD SUPPPORT	1	PZ	VP1005B0	70 MM BIG-L DOOR CONTROL SUPPORT	1	PZ	VP1078A0	MM CONTROL BOARD PARTITION FRAME	1	PZ
					Code	Description	Qty	UOM																																									
					CE2007A0	4PM-MINIFIT 4PF 100mm MICROFIT CABLE	1	PZ																																									
					PE1062A0	MM PLUS BIG CAPACITIVE CONTROL PANEL	1	PZ																																									
					VI1074A0	4X16 SCREW FOR PLASTIC	2	PZ																																									
					VI1103A0	40X12 TBSP SCREW FOR PLASTIC	2	PZ																																									
					VM2147A0	410X343X15 MM PINK SMOOTH ESD SPONGE	1	PZ																																									
					VM2295A1	MIND.MAPS TOUCH CONTROL STYLUS KIT	1	PZ																																									
					VM2583A1		1	PZ																																									
					VP1005A0	BIG-L DOOR CONTROL BOARD SUPPPORT	1	PZ																																									
					VP1005B0	70 MM BIG-L DOOR CONTROL SUPPORT	1	PZ																																									
					VP1078A0	MM CONTROL BOARD PARTITION FRAME	1	PZ																																									
					VE1550A	5X3 MM NEODYMIUM MAGNET		KPE1710B	MOTOR REVOLUTIONS SENSOR KIT	<table border="1"> <thead> <tr> <th>Code</th> <th>Description</th> <th>Qty</th> <th>UOM</th> </tr> </thead> <tbody> <tr> <td>CE1119A0</td> <td>AMPMODU2 4P 4XAWG22 L1500 RAST 4P CABLE</td> <td>1</td> <td>PZ</td> </tr> <tr> <td>PE1040A0</td> <td>RAST MOTOR SENSOR</td> <td>1</td> <td>PZ</td> </tr> <tr> <td>PE1710B0</td> <td>MOTOR REVOLUTION AND DIRECTION SENSOR</td> <td>1</td> <td>PZ</td> </tr> <tr> <td>VE1550A0</td> <td>5X3 MM NEODYMIUM MAGNET</td> <td>1</td> <td>PZ</td> </tr> <tr> <td>VI1966A0</td> <td>M4X14 FLATHEAD SCREW</td> <td>1</td> <td>PZ</td> </tr> <tr> <td>VM1635A0</td> <td>MAGNET HOLDING DIS</td> <td>1</td> <td>PZ</td> </tr> </tbody> </table>	Code	Description	Qty	UOM	CE1119A0	AMPMODU2 4P 4XAWG22 L1500 RAST 4P CABLE	1	PZ	PE1040A0	RAST MOTOR SENSOR	1	PZ	PE1710B0	MOTOR REVOLUTION AND DIRECTION SENSOR	1	PZ	VE1550A0	5X3 MM NEODYMIUM MAGNET	1	PZ	VI1966A0	M4X14 FLATHEAD SCREW	1	PZ	VM1635A0	MAGNET HOLDING DIS	1	PZ											
Code	Description	Qty	UOM																																														
CE1119A0	AMPMODU2 4P 4XAWG22 L1500 RAST 4P CABLE	1	PZ																																														
PE1040A0	RAST MOTOR SENSOR	1	PZ																																														
PE1710B0	MOTOR REVOLUTION AND DIRECTION SENSOR	1	PZ																																														
VE1550A0	5X3 MM NEODYMIUM MAGNET	1	PZ																																														
VI1966A0	M4X14 FLATHEAD SCREW	1	PZ																																														
VM1635A0	MAGNET HOLDING DIS	1	PZ																																														

COMPONENT			SPARE PART																										
Code	Description	Image	Code	Description	Components list																								
VI1074A	4X16 SCREW FOR PLASTIC		VI1074A0	4X16 SCREW FOR PLASTIC																									
VM2615A	HANDLE FIXING COVER		VM2615A0	HANDLE FIXING COVER																									
0H8033A	BIG HANDLE FIXING WASHER		0H8033A0	BIG HANDLE FIXING WASHER																									
VM2587B	BIG OVEN PUSH-TO-CLOSE RIGHT HANDLE PIN		KVM2587B	BIG OVEN PUSH-TO-CLOSE RIGHT HANDLE PIN	<table border="1"> <thead> <tr> <th>Code</th> <th>Description</th> <th>Qty</th> <th>UOM</th> </tr> </thead> <tbody> <tr> <td>0H8033A0</td> <td>BIG HANDLE FIXING WASHER</td> <td>1</td> <td>PZ</td> </tr> <tr> <td>VE1550A0</td> <td>5X3 MM NEODYMIUM MAGNET</td> <td>2</td> <td>PZ</td> </tr> <tr> <td>VI1101A0</td> <td>M5X20 TSP-EI ST.STEEL DIN 7991 SCREW</td> <td>1</td> <td>PZ</td> </tr> <tr> <td>VM1224A0</td> <td>65MY 220MM 2 COLOURS SHRINK TUBE</td> <td>0.300</td> <td>M</td> </tr> <tr> <td>VM2587B0</td> <td>BIG OVEN PUSH-TO-CLOSE RIGHT HANDLE PIN</td> <td>1</td> <td>PZ</td> </tr> </tbody> </table>	Code	Description	Qty	UOM	0H8033A0	BIG HANDLE FIXING WASHER	1	PZ	VE1550A0	5X3 MM NEODYMIUM MAGNET	2	PZ	VI1101A0	M5X20 TSP-EI ST.STEEL DIN 7991 SCREW	1	PZ	VM1224A0	65MY 220MM 2 COLOURS SHRINK TUBE	0.300	M	VM2587B0	BIG OVEN PUSH-TO-CLOSE RIGHT HANDLE PIN	1	PZ
Code	Description	Qty	UOM																										
0H8033A0	BIG HANDLE FIXING WASHER	1	PZ																										
VE1550A0	5X3 MM NEODYMIUM MAGNET	2	PZ																										
VI1101A0	M5X20 TSP-EI ST.STEEL DIN 7991 SCREW	1	PZ																										
VM1224A0	65MY 220MM 2 COLOURS SHRINK TUBE	0.300	M																										
VM2587B0	BIG OVEN PUSH-TO-CLOSE RIGHT HANDLE PIN	1	PZ																										

COMPONENT			SPARE PART																																																																																																		
Code	Description	Image	Code	Description	Components list																																																																																																
VI1117A			VI1117A0																																																																																																		
MG1100A			KMG1095A	BIG-L PUSH-TO-CLOSE RIGHT HANDLE KIT	<table border="1"> <thead> <tr> <th>Code</th> <th>Description</th> <th>Qty</th> <th>UOM</th> </tr> </thead> <tbody> <tr> <td>0H8030A0</td> <td></td> <td>1</td> <td>PZ</td> </tr> <tr> <td>0H8033A0</td> <td>BIG HANDLE FIXING WASHER</td> <td>1</td> <td>PZ</td> </tr> <tr> <td>MG1095A0</td> <td>BIG PUSH-TO-CLO SE RIGHT HANDLE ASM</td> <td>1</td> <td>PZ</td> </tr> <tr> <td>MG1095A1</td> <td></td> <td>1</td> <td>PZ</td> </tr> <tr> <td>MG1095A2</td> <td></td> <td>1</td> <td>PZ</td> </tr> <tr> <td>MG1095A3</td> <td></td> <td>1</td> <td>PZ</td> </tr> <tr> <td>MG1095A4</td> <td>BIG RIGHT SLAM DOOR HANDLE</td> <td>1</td> <td>PZ</td> </tr> <tr> <td>ML1009A0</td> <td></td> <td>3</td> <td>PZ</td> </tr> <tr> <td>SL1155A1</td> <td>LOCTITE BICOMPONEN T SILICON</td> <td>10</td> <td>ML</td> </tr> <tr> <td>TF1073A0</td> <td></td> <td>1</td> <td>PZ</td> </tr> <tr> <td>VE1550A0</td> <td>5X3 MM NEODYMIUM MAGNET</td> <td>2</td> <td>PZ</td> </tr> <tr> <td>VI1042A0</td> <td>SCREW M5X20 TCEI ZN</td> <td>1</td> <td>PZ</td> </tr> <tr> <td>VI1074A0</td> <td>4X16 SCREW FOR PLASTIC</td> <td>7</td> <td>PZ</td> </tr> <tr> <td>VI1101A0</td> <td>M5X20 TSP-EI ST.STEEL DIN 7991 SCREW</td> <td>1</td> <td>PZ</td> </tr> <tr> <td>VM2580A0</td> <td></td> <td>1</td> <td>PZ</td> </tr> <tr> <td>VM2581A0</td> <td></td> <td>1</td> <td>PZ</td> </tr> <tr> <td>VM2582A0</td> <td></td> <td>1</td> <td>PZ</td> </tr> <tr> <td>VM2583A0</td> <td>BIG PUSH-TO-CLO SE HANDLE PE</td> <td>1</td> <td>PZ</td> </tr> <tr> <td>VM2584A0</td> <td></td> <td>1</td> <td>PZ</td> </tr> <tr> <td>VM2585B0</td> <td>BIG HANDLE COVER SUPPORT</td> <td>1</td> <td>PZ</td> </tr> <tr> <td>VM2586A0</td> <td></td> <td>2</td> <td>PZ</td> </tr> <tr> <td>VM2587B0</td> <td>BIG OVEN PUSH-TO-CLO SE RIGHT HANDLE PIN</td> <td>1</td> <td>PZ</td> </tr> <tr> <td>VM2615A0</td> <td>HANDLE FIXING COVER</td> <td>1</td> <td>PZ</td> </tr> </tbody> </table>	Code	Description	Qty	UOM	0H8030A0		1	PZ	0H8033A0	BIG HANDLE FIXING WASHER	1	PZ	MG1095A0	BIG PUSH-TO-CLO SE RIGHT HANDLE ASM	1	PZ	MG1095A1		1	PZ	MG1095A2		1	PZ	MG1095A3		1	PZ	MG1095A4	BIG RIGHT SLAM DOOR HANDLE	1	PZ	ML1009A0		3	PZ	SL1155A1	LOCTITE BICOMPONEN T SILICON	10	ML	TF1073A0		1	PZ	VE1550A0	5X3 MM NEODYMIUM MAGNET	2	PZ	VI1042A0	SCREW M5X20 TCEI ZN	1	PZ	VI1074A0	4X16 SCREW FOR PLASTIC	7	PZ	VI1101A0	M5X20 TSP-EI ST.STEEL DIN 7991 SCREW	1	PZ	VM2580A0		1	PZ	VM2581A0		1	PZ	VM2582A0		1	PZ	VM2583A0	BIG PUSH-TO-CLO SE HANDLE PE	1	PZ	VM2584A0		1	PZ	VM2585B0	BIG HANDLE COVER SUPPORT	1	PZ	VM2586A0		2	PZ	VM2587B0	BIG OVEN PUSH-TO-CLO SE RIGHT HANDLE PIN	1	PZ	VM2615A0	HANDLE FIXING COVER	1	PZ
Code	Description	Qty	UOM																																																																																																		
0H8030A0		1	PZ																																																																																																		
0H8033A0	BIG HANDLE FIXING WASHER	1	PZ																																																																																																		
MG1095A0	BIG PUSH-TO-CLO SE RIGHT HANDLE ASM	1	PZ																																																																																																		
MG1095A1		1	PZ																																																																																																		
MG1095A2		1	PZ																																																																																																		
MG1095A3		1	PZ																																																																																																		
MG1095A4	BIG RIGHT SLAM DOOR HANDLE	1	PZ																																																																																																		
ML1009A0		3	PZ																																																																																																		
SL1155A1	LOCTITE BICOMPONEN T SILICON	10	ML																																																																																																		
TF1073A0		1	PZ																																																																																																		
VE1550A0	5X3 MM NEODYMIUM MAGNET	2	PZ																																																																																																		
VI1042A0	SCREW M5X20 TCEI ZN	1	PZ																																																																																																		
VI1074A0	4X16 SCREW FOR PLASTIC	7	PZ																																																																																																		
VI1101A0	M5X20 TSP-EI ST.STEEL DIN 7991 SCREW	1	PZ																																																																																																		
VM2580A0		1	PZ																																																																																																		
VM2581A0		1	PZ																																																																																																		
VM2582A0		1	PZ																																																																																																		
VM2583A0	BIG PUSH-TO-CLO SE HANDLE PE	1	PZ																																																																																																		
VM2584A0		1	PZ																																																																																																		
VM2585B0	BIG HANDLE COVER SUPPORT	1	PZ																																																																																																		
VM2586A0		2	PZ																																																																																																		
VM2587B0	BIG OVEN PUSH-TO-CLO SE RIGHT HANDLE PIN	1	PZ																																																																																																		
VM2615A0	HANDLE FIXING COVER	1	PZ																																																																																																		





ASM2460A/0.D07 - External cover

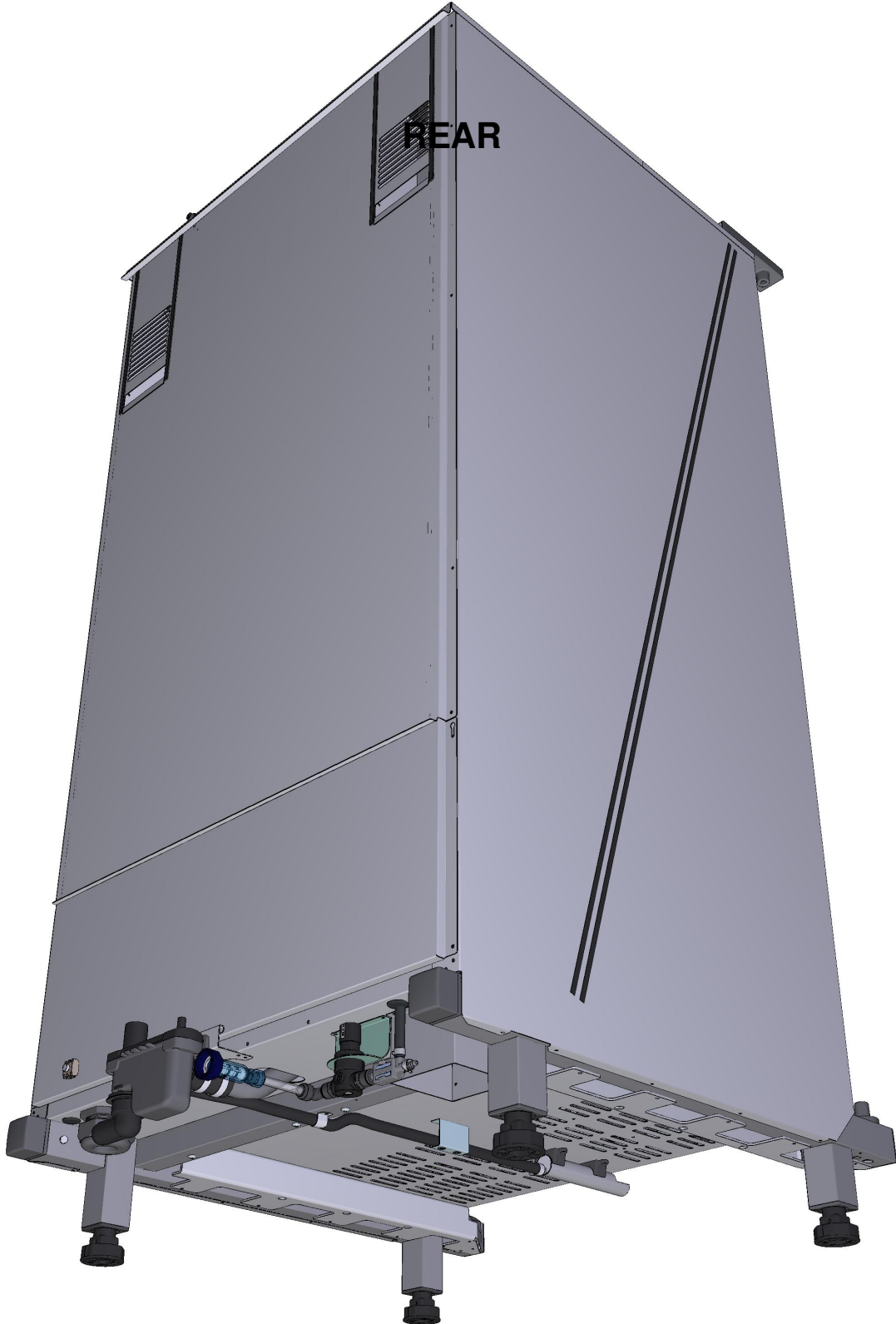

ASM2460A/0.D07 - External cover

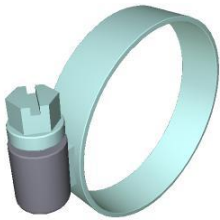





COMPONENT			SPARE PART																																																														
Code	Description	Image	Code	Description	Components list																																																												
RC1378A	HOSE CLAMP		KVE1135A	SERIES 5/5E VENTURI KIT	<table border="1"> <thead> <tr> <th>Code</th> <th>Description</th> <th>Qty</th> <th>UOM</th> </tr> </thead> <tbody> <tr> <td>GN1556A0</td> <td>MM VENTURI SEAL</td> <td>1</td> <td>PZ</td> </tr> <tr> <td>RC1378A0</td> <td>HOSE CLAMP</td> <td>2</td> <td>PZ</td> </tr> <tr> <td>TB1520A0</td> <td>INT. Ø=38 TH=4 DRAIN BLACK RUBBER PIPE</td> <td>0.050</td> <td>M</td> </tr> <tr> <td>VE1135A0</td> <td>220 V 50/60 HZ VENTURI ACTUATOR</td> <td>1</td> <td>PZ</td> </tr> <tr> <td>VI1032A0</td> <td>SCREW M4X16 TCB+ INOX</td> <td>1</td> <td>PZ</td> </tr> <tr> <td>VI1511A0</td> <td>STAINLESS STEEL WASHER 4.2X12X1</td> <td>2</td> <td>PZ</td> </tr> <tr> <td>VI1850A0</td> <td>M4X6 NICKEL PLATED FIXING SCREW</td> <td>2</td> <td>PZ</td> </tr> <tr> <td>VI1865A0</td> <td>5X10 TCB+ SELF-THREADING SCREW</td> <td>3</td> <td>PZ</td> </tr> <tr> <td>VI1965A0</td> <td>M4X6 CROSS-HEAD ST. STEEL SCREW</td> <td>2</td> <td>PZ</td> </tr> <tr> <td>VM1224A0</td> <td>65MY 220MM COLOURS SHRINK TUBE</td> <td>0.250</td> <td>M</td> </tr> <tr> <td>VM1565B0</td> <td>VENTURI LOWER COIL SUPPORT</td> <td>1</td> <td>PZ</td> </tr> <tr> <td>VM1566A0</td> <td>VENTURI UPPER COIL SUPPORT</td> <td>1</td> <td>PZ</td> </tr> <tr> <td>VM1567A0</td> <td>VENTURI LOWER BUSHING</td> <td>1</td> <td>PZ</td> </tr> <tr> <td>VM1568A0</td> <td>VENTURI PLATE SPACE</td> <td>1</td> <td>PZ</td> </tr> </tbody> </table>	Code	Description	Qty	UOM	GN1556A0	MM VENTURI SEAL	1	PZ	RC1378A0	HOSE CLAMP	2	PZ	TB1520A0	INT. Ø=38 TH=4 DRAIN BLACK RUBBER PIPE	0.050	M	VE1135A0	220 V 50/60 HZ VENTURI ACTUATOR	1	PZ	VI1032A0	SCREW M4X16 TCB+ INOX	1	PZ	VI1511A0	STAINLESS STEEL WASHER 4.2X12X1	2	PZ	VI1850A0	M4X6 NICKEL PLATED FIXING SCREW	2	PZ	VI1865A0	5X10 TCB+ SELF-THREADING SCREW	3	PZ	VI1965A0	M4X6 CROSS-HEAD ST. STEEL SCREW	2	PZ	VM1224A0	65MY 220MM COLOURS SHRINK TUBE	0.250	M	VM1565B0	VENTURI LOWER COIL SUPPORT	1	PZ	VM1566A0	VENTURI UPPER COIL SUPPORT	1	PZ	VM1567A0	VENTURI LOWER BUSHING	1	PZ	VM1568A0	VENTURI PLATE SPACE	1	PZ
					Code	Description	Qty	UOM																																																									
					GN1556A0	MM VENTURI SEAL	1	PZ																																																									
					RC1378A0	HOSE CLAMP	2	PZ																																																									
					TB1520A0	INT. Ø=38 TH=4 DRAIN BLACK RUBBER PIPE	0.050	M																																																									
					VE1135A0	220 V 50/60 HZ VENTURI ACTUATOR	1	PZ																																																									
					VI1032A0	SCREW M4X16 TCB+ INOX	1	PZ																																																									
					VI1511A0	STAINLESS STEEL WASHER 4.2X12X1	2	PZ																																																									
					VI1850A0	M4X6 NICKEL PLATED FIXING SCREW	2	PZ																																																									
					VI1865A0	5X10 TCB+ SELF-THREADING SCREW	3	PZ																																																									
					VI1965A0	M4X6 CROSS-HEAD ST. STEEL SCREW	2	PZ																																																									
					VM1224A0	65MY 220MM COLOURS SHRINK TUBE	0.250	M																																																									
					VM1565B0	VENTURI LOWER COIL SUPPORT	1	PZ																																																									
					VM1566A0	VENTURI UPPER COIL SUPPORT	1	PZ																																																									
					VM1567A0	VENTURI LOWER BUSHING	1	PZ																																																									
VM1568A0	VENTURI PLATE SPACE	1	PZ																																																														
GN1558A	EXHAUST SEAL		K0H7291A	GASKET AND SEALING DISC CHIMNEY KIT	<table border="1"> <thead> <tr> <th>Code</th> <th>Description</th> <th>Qty</th> <th>UOM</th> </tr> </thead> <tbody> <tr> <td>0H7291A0</td> <td>CHIMNEY HOLDING DISC</td> <td>1</td> <td>PZ</td> </tr> <tr> <td>GN1558A0</td> <td>EXHAUST SEAL</td> <td>1</td> <td>PZ</td> </tr> <tr> <td>VM1224A0</td> <td>65MY 220MM COLOURS SHRINK TUBE</td> <td>0.200</td> <td>M</td> </tr> </tbody> </table>	Code	Description	Qty	UOM	0H7291A0	CHIMNEY HOLDING DISC	1	PZ	GN1558A0	EXHAUST SEAL	1	PZ	VM1224A0	65MY 220MM COLOURS SHRINK TUBE	0.200	M																																												
					Code	Description	Qty	UOM																																																									
					0H7291A0	CHIMNEY HOLDING DISC	1	PZ																																																									
GN1558A0	EXHAUST SEAL	1	PZ																																																														
VM1224A0	65MY 220MM COLOURS SHRINK TUBE	0.200	M																																																														





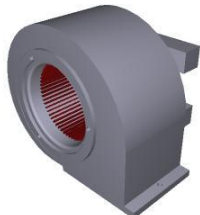

COMPONENT			SPARE PART																																						
Code	Description	Image	Code	Description	Components list																																				
0H7291A	CHIMNEY HOLDING DISC		K0H7291A	GASKET AND SEALING DISC CHIMNEY KIT	<table border="1"> <thead> <tr> <th>Code</th> <th>Description</th> <th>Qty</th> <th>UOM</th> </tr> </thead> <tbody> <tr> <td>0H7291A0</td> <td>CHIMNEY HOLDING DISC</td> <td>1</td> <td>PZ</td> </tr> <tr> <td>GN1558A0</td> <td>EXHAUST SEA</td> <td>1</td> <td>PZ</td> </tr> <tr> <td>VM1224A0</td> <td>65MY 220MM 2 COLOURS SHRINK TUBE</td> <td>0.200</td> <td>M</td> </tr> </tbody> </table>	Code	Description	Qty	UOM	0H7291A0	CHIMNEY HOLDING DISC	1	PZ	GN1558A0	EXHAUST SEA	1	PZ	VM1224A0	65MY 220MM 2 COLOURS SHRINK TUBE	0.200	M																				
Code	Description	Qty	UOM																																						
0H7291A0	CHIMNEY HOLDING DISC	1	PZ																																						
GN1558A0	EXHAUST SEA	1	PZ																																						
VM1224A0	65MY 220MM 2 COLOURS SHRINK TUBE	0.200	M																																						
VM1240A	NYLON SUPPORT CAP		KVM1240A	4 PCS COUNTER BRACKET SUPPORT CAP KIT	<table border="1"> <thead> <tr> <th>Code</th> <th>Description</th> <th>Qty</th> <th>UOM</th> </tr> </thead> <tbody> <tr> <td>VM1224A0</td> <td>65MY 220MM 2 COLOURS SHRINK TUBE</td> <td>0.200</td> <td>M</td> </tr> <tr> <td>VM1240A0</td> <td>NYLON SUPPORT CAP</td> <td>4</td> <td>PZ</td> </tr> </tbody> </table>	Code	Description	Qty	UOM	VM1224A0	65MY 220MM 2 COLOURS SHRINK TUBE	0.200	M	VM1240A0	NYLON SUPPORT CAP	4	PZ																								
Code	Description	Qty	UOM																																						
VM1224A0	65MY 220MM 2 COLOURS SHRINK TUBE	0.200	M																																						
VM1240A0	NYLON SUPPORT CAP	4	PZ																																						
VM2282A	MICROSWITCH SUPPORT COVER		KVM2282A	MICROSWITCH SUPPORT PLATE KI	<table border="1"> <thead> <tr> <th>Code</th> <th>Description</th> <th>Qty</th> <th>UOM</th> </tr> </thead> <tbody> <tr> <td>VM1224A0</td> <td>65MY 220MM 2 COLOURS SHRINK TUBE</td> <td>0.200</td> <td>M</td> </tr> <tr> <td>VM2282A0</td> <td>MICROSWITC H SUPPORT COVER</td> <td>1</td> <td>PZ</td> </tr> </tbody> </table>	Code	Description	Qty	UOM	VM1224A0	65MY 220MM 2 COLOURS SHRINK TUBE	0.200	M	VM2282A0	MICROSWITC H SUPPORT COVER	1	PZ																								
Code	Description	Qty	UOM																																						
VM1224A0	65MY 220MM 2 COLOURS SHRINK TUBE	0.200	M																																						
VM2282A0	MICROSWITC H SUPPORT COVER	1	PZ																																						
VE1020B	MAGNET DOOR MICROSWITCH		KVE1020B	MICROSWITCH KIT	<table border="1"> <thead> <tr> <th>Code</th> <th>Description</th> <th>Qty</th> <th>UOM</th> </tr> </thead> <tbody> <tr> <td>CE1030A0</td> <td>FEMALE FASTON COVER 6.3X0.8 0.5-1MMQ</td> <td>2</td> <td>PZ</td> </tr> <tr> <td>CE1660A0</td> <td>6,3X0,8 FEMALE FASTON COVE</td> <td>2</td> <td>PZ</td> </tr> <tr> <td>CE1730A0</td> <td>PVC CABLE NP 2 X AWG22 STYLE 2095</td> <td>0.150</td> <td>M</td> </tr> <tr> <td>CE1740A0</td> <td>MINIFIT MALE END FITTING</td> <td>2</td> <td>PZ</td> </tr> <tr> <td>CE1745A0</td> <td>2 WAYS FEMALE MINIFIT CONNECTOR</td> <td>1</td> <td>PZ</td> </tr> <tr> <td>VE1020B0</td> <td>MAGNET DOOR MICROSWITC</td> <td>1</td> <td>PZ</td> </tr> <tr> <td>VE1030A1</td> <td>MAGNET FOR DOOR MICROSWITC H D=22.9MM</td> <td>1</td> <td>PZ</td> </tr> <tr> <td>VM1224A0</td> <td>65MY 220MM 2 COLOURS SHRINK TUBE</td> <td>0.250</td> <td>M</td> </tr> </tbody> </table>	Code	Description	Qty	UOM	CE1030A0	FEMALE FASTON COVER 6.3X0.8 0.5-1MMQ	2	PZ	CE1660A0	6,3X0,8 FEMALE FASTON COVE	2	PZ	CE1730A0	PVC CABLE NP 2 X AWG22 STYLE 2095	0.150	M	CE1740A0	MINIFIT MALE END FITTING	2	PZ	CE1745A0	2 WAYS FEMALE MINIFIT CONNECTOR	1	PZ	VE1020B0	MAGNET DOOR MICROSWITC	1	PZ	VE1030A1	MAGNET FOR DOOR MICROSWITC H D=22.9MM	1	PZ	VM1224A0	65MY 220MM 2 COLOURS SHRINK TUBE	0.250	M
Code	Description	Qty	UOM																																						
CE1030A0	FEMALE FASTON COVER 6.3X0.8 0.5-1MMQ	2	PZ																																						
CE1660A0	6,3X0,8 FEMALE FASTON COVE	2	PZ																																						
CE1730A0	PVC CABLE NP 2 X AWG22 STYLE 2095	0.150	M																																						
CE1740A0	MINIFIT MALE END FITTING	2	PZ																																						
CE1745A0	2 WAYS FEMALE MINIFIT CONNECTOR	1	PZ																																						
VE1020B0	MAGNET DOOR MICROSWITC	1	PZ																																						
VE1030A1	MAGNET FOR DOOR MICROSWITC H D=22.9MM	1	PZ																																						
VM1224A0	65MY 220MM 2 COLOURS SHRINK TUBE	0.250	M																																						



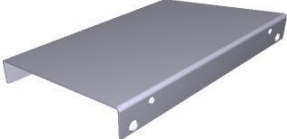





COMPONENT			SPARE PART																										
Code	Description	Image	Code	Description	Components list																								
0H2170A	XEVL REINFORCING BAR		0H2170A0	XEVL REINFORCING BAR																									
0H2171A	FAN SUPPORT PLAT		0H2171A1	FAN SUPPORT PLAT																									
MT1015A			KMT1015A	DECK OVEN FAN MOTOR KIT	<table border="1"> <thead> <tr> <th>Code</th> <th>Description</th> <th>Qty</th> <th>UOM</th> </tr> </thead> <tbody> <tr> <td>IP1385A1</td> <td>CORNER POLYSTYRENE PACKING 110X80X2000</td> <td>0.430</td> <td>M</td> </tr> <tr> <td>MT1015A0</td> <td>CENTRIFUGAL FAN DECK TO</td> <td>1</td> <td>PZ</td> </tr> <tr> <td>MT1015A1</td> <td></td> <td>1</td> <td>PZ</td> </tr> </tbody> </table>	Code	Description	Qty	UOM	IP1385A1	CORNER POLYSTYRENE PACKING 110X80X2000	0.430	M	MT1015A0	CENTRIFUGAL FAN DECK TO	1	PZ	MT1015A1		1	PZ								
Code	Description	Qty	UOM																										
IP1385A1	CORNER POLYSTYRENE PACKING 110X80X2000	0.430	M																										
MT1015A0	CENTRIFUGAL FAN DECK TO	1	PZ																										
MT1015A1		1	PZ																										
VN1165A	230VAC 50/60HZ COOLING DOWN FA		KVN1165A	S.5E ADVANCE/MM 230V COOLING FAN KIT	<table border="1"> <thead> <tr> <th>Code</th> <th>Description</th> <th>Qty</th> <th>UOM</th> </tr> </thead> <tbody> <tr> <td>MOV0017A0</td> <td>HOOD RING GASKET GN1110A2</td> <td>0.100</td> <td>PZ</td> </tr> <tr> <td>VI1099A0</td> <td>SELF-DRILLING SCREW 4.8X13 TCB+ Z</td> <td>4</td> <td>PZ</td> </tr> <tr> <td>VM1555A2</td> <td>CT BT COOLING FAN SUPPORT</td> <td>1</td> <td>PZ</td> </tr> <tr> <td>VN1165A0</td> <td>230VAC 50/60HZ COOLING DOWN FAN</td> <td>1</td> <td>PZ</td> </tr> <tr> <td>VN1165A0</td> <td>230VAC 50/60HZ COOLING DOWN FAN</td> <td>1</td> <td>PZ</td> </tr> </tbody> </table>	Code	Description	Qty	UOM	MOV0017A0	HOOD RING GASKET GN1110A2	0.100	PZ	VI1099A0	SELF-DRILLING SCREW 4.8X13 TCB+ Z	4	PZ	VM1555A2	CT BT COOLING FAN SUPPORT	1	PZ	VN1165A0	230VAC 50/60HZ COOLING DOWN FAN	1	PZ	VN1165A0	230VAC 50/60HZ COOLING DOWN FAN	1	PZ
Code	Description	Qty	UOM																										
MOV0017A0	HOOD RING GASKET GN1110A2	0.100	PZ																										
VI1099A0	SELF-DRILLING SCREW 4.8X13 TCB+ Z	4	PZ																										
VM1555A2	CT BT COOLING FAN SUPPORT	1	PZ																										
VN1165A0	230VAC 50/60HZ COOLING DOWN FAN	1	PZ																										
VN1165A0	230VAC 50/60HZ COOLING DOWN FAN	1	PZ																										





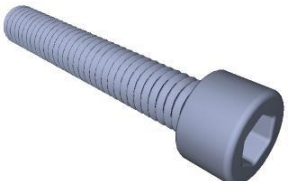

COMPONENT			SPARE PART		
Code	Description	Image	Code	Description	Components list
0H2178A	XEVL-20XX COOLING DOWN SLIDE		0H2178A0	XEVL-20XX COOLING DOWN SLIDE	
GN0063A			GN0063A0		
0H2177A	XEVL-20XX COOLING FAN HOLDER		0H2177A0	XEVL-20XX COOLING FAN HOLDER	
0H2179A	XEVL-20XX VENTILATION BOX RIGHT PARTITIO		0H2179A0	XEVL-20XX VENTILATION BOX RIGHT PARTITIO	
0H2180A	XEVL-20XX VENTILATION BOX LEFT PARTITION		0H2180A0	XEVL-20XX VENTILATION BOX LEFT PARTITION	



COMPONENT			SPARE PART																																						
Code	Description	Image	Code	Description	Components list																																				
VM1240A	NYLON SUPPORT CAP		KVM1240A	4 PCS COUNTER BRACKET SUPPORT CAP KIT	<table border="1"> <thead> <tr> <th>Code</th> <th>Description</th> <th>Qty</th> <th>UOM</th> </tr> </thead> <tbody> <tr> <td>VM1224A0</td> <td>65MY 220MM 2 COLOURS SHRINK TUBE</td> <td>0.200</td> <td>M</td> </tr> <tr> <td>VM1240A0</td> <td>NYLON SUPPORT CAP</td> <td>4</td> <td>PZ</td> </tr> </tbody> </table>	Code	Description	Qty	UOM	VM1224A0	65MY 220MM 2 COLOURS SHRINK TUBE	0.200	M	VM1240A0	NYLON SUPPORT CAP	4	PZ																								
Code	Description	Qty	UOM																																						
VM1224A0	65MY 220MM 2 COLOURS SHRINK TUBE	0.200	M																																						
VM1240A0	NYLON SUPPORT CAP	4	PZ																																						
VE1020B	MAGNET DOOR MICROSWITCH		KVE1020B	MICROSWITCH KIT	<table border="1"> <thead> <tr> <th>Code</th> <th>Description</th> <th>Qty</th> <th>UOM</th> </tr> </thead> <tbody> <tr> <td>CE1030A0</td> <td>FEMALE FASTON COVER 6.3X0.8 0.5-1MMQ</td> <td>2</td> <td>PZ</td> </tr> <tr> <td>CE1660A0</td> <td>6.3X0.8 FEMALE FASTON COVE</td> <td>2</td> <td>PZ</td> </tr> <tr> <td>CE1730A0</td> <td>PVC CABLE NP 2 X AWG22 STYLE 2095</td> <td>0.150</td> <td>M</td> </tr> <tr> <td>CE1740A0</td> <td>MINIFIT MALE END FITTING</td> <td>2</td> <td>PZ</td> </tr> <tr> <td>CE1745A0</td> <td>2 WAYS FEMALE MINIFIT CONNECTOR</td> <td>1</td> <td>PZ</td> </tr> <tr> <td>VE1020B0</td> <td>MAGNET DOOR MICROSWITC</td> <td>1</td> <td>PZ</td> </tr> <tr> <td>VE1030A1</td> <td>MAGNET FOR DOOR MICROSWITC H D=22.9MM</td> <td>1</td> <td>PZ</td> </tr> <tr> <td>VM1224A0</td> <td>65MY 220MM 2 COLOURS SHRINK TUBE</td> <td>0.250</td> <td>M</td> </tr> </tbody> </table>	Code	Description	Qty	UOM	CE1030A0	FEMALE FASTON COVER 6.3X0.8 0.5-1MMQ	2	PZ	CE1660A0	6.3X0.8 FEMALE FASTON COVE	2	PZ	CE1730A0	PVC CABLE NP 2 X AWG22 STYLE 2095	0.150	M	CE1740A0	MINIFIT MALE END FITTING	2	PZ	CE1745A0	2 WAYS FEMALE MINIFIT CONNECTOR	1	PZ	VE1020B0	MAGNET DOOR MICROSWITC	1	PZ	VE1030A1	MAGNET FOR DOOR MICROSWITC H D=22.9MM	1	PZ	VM1224A0	65MY 220MM 2 COLOURS SHRINK TUBE	0.250	M
Code	Description	Qty	UOM																																						
CE1030A0	FEMALE FASTON COVER 6.3X0.8 0.5-1MMQ	2	PZ																																						
CE1660A0	6.3X0.8 FEMALE FASTON COVE	2	PZ																																						
CE1730A0	PVC CABLE NP 2 X AWG22 STYLE 2095	0.150	M																																						
CE1740A0	MINIFIT MALE END FITTING	2	PZ																																						
CE1745A0	2 WAYS FEMALE MINIFIT CONNECTOR	1	PZ																																						
VE1020B0	MAGNET DOOR MICROSWITC	1	PZ																																						
VE1030A1	MAGNET FOR DOOR MICROSWITC H D=22.9MM	1	PZ																																						
VM1224A0	65MY 220MM 2 COLOURS SHRINK TUBE	0.250	M																																						
0H2016A	XEVL-20XX DOOR LATCH COUNTER BRACKET		0H2016A0	XEVL-20XX DOOR LATCH COUNTER BRACKET																																					

COMPONENT			SPARE PART																																										
Code	Description	Image	Code	Description	Components list																																								
VI1088A	M5X30 TCEI ST.STEEL DIN 912 SCREW		VI1088A0	M5X30 TCEI ST.STEEL DIN 912 SCREW																																									
MG1097A	BIG-L PUSH-TO-CLOSE LATCH		KMG1097A	BIG-L PUSH-TO-CLOSE LATCH KIT	<table border="1"> <thead> <tr> <th>Code</th> <th>Description</th> <th>Qty</th> <th>UOM</th> </tr> </thead> <tbody> <tr> <td>MG1097A0</td> <td></td> <td>1</td> <td>PZ</td> </tr> <tr> <td>MG1097A1</td> <td>BIG-L PUSH-TO-CLO SE LATCH</td> <td>1</td> <td>PZ</td> </tr> <tr> <td>ML1010A0</td> <td></td> <td>4</td> <td>PZ</td> </tr> <tr> <td>VI1074A0</td> <td>4X16 SCREW FOR PLASTIC</td> <td>2</td> <td>PZ</td> </tr> <tr> <td>VI1088A0</td> <td>M5X30 TCEI ST.STEEL DIN 912 SCREW</td> <td>6</td> <td>PZ</td> </tr> <tr> <td>VM1224A0</td> <td>65MY 220MM 2 COLOURS SHRINK TUBE</td> <td>0.250</td> <td>M</td> </tr> <tr> <td>VM1348A0</td> <td></td> <td>1</td> <td>PZ</td> </tr> <tr> <td>VM2588B0</td> <td>BIG PUSH-TO-CLO SE LATCH</td> <td>2</td> <td>PZ</td> </tr> <tr> <td>VM2589B0</td> <td></td> <td>2</td> <td>PZ</td> </tr> </tbody> </table>	Code	Description	Qty	UOM	MG1097A0		1	PZ	MG1097A1	BIG-L PUSH-TO-CLO SE LATCH	1	PZ	ML1010A0		4	PZ	VI1074A0	4X16 SCREW FOR PLASTIC	2	PZ	VI1088A0	M5X30 TCEI ST.STEEL DIN 912 SCREW	6	PZ	VM1224A0	65MY 220MM 2 COLOURS SHRINK TUBE	0.250	M	VM1348A0		1	PZ	VM2588B0	BIG PUSH-TO-CLO SE LATCH	2	PZ	VM2589B0		2	PZ
Code	Description	Qty	UOM																																										
MG1097A0		1	PZ																																										
MG1097A1	BIG-L PUSH-TO-CLO SE LATCH	1	PZ																																										
ML1010A0		4	PZ																																										
VI1074A0	4X16 SCREW FOR PLASTIC	2	PZ																																										
VI1088A0	M5X30 TCEI ST.STEEL DIN 912 SCREW	6	PZ																																										
VM1224A0	65MY 220MM 2 COLOURS SHRINK TUBE	0.250	M																																										
VM1348A0		1	PZ																																										
VM2588B0	BIG PUSH-TO-CLO SE LATCH	2	PZ																																										
VM2589B0		2	PZ																																										
GN0064A			GN0064A0																																										
GN1673A	GN1613A-XEBL/XEV L DOOR GASKET		KGN1673A	BIG-L DOOR GASKET KIT	<table border="1"> <thead> <tr> <th>Code</th> <th>Description</th> <th>Qty</th> <th>UOM</th> </tr> </thead> <tbody> <tr> <td>GN1613A0</td> <td>H18 PB DOOR GASKET</td> <td>4.360</td> <td>M</td> </tr> <tr> <td>VM1224A0</td> <td>65MY 220MM 2 COLOURS SHRINK TUBE</td> <td>0.450</td> <td>M</td> </tr> <tr> <td>VM1227A0</td> <td>GN1613 GASKET JUNCTION PLUG</td> <td>1</td> <td>PZ</td> </tr> <tr> <td>VM2277A0</td> <td>DOOR SEAL KIT INTERNAL CONNECTION</td> <td>1</td> <td>PZ</td> </tr> </tbody> </table>	Code	Description	Qty	UOM	GN1613A0	H18 PB DOOR GASKET	4.360	M	VM1224A0	65MY 220MM 2 COLOURS SHRINK TUBE	0.450	M	VM1227A0	GN1613 GASKET JUNCTION PLUG	1	PZ	VM2277A0	DOOR SEAL KIT INTERNAL CONNECTION	1	PZ																				
Code	Description	Qty	UOM																																										
GN1613A0	H18 PB DOOR GASKET	4.360	M																																										
VM1224A0	65MY 220MM 2 COLOURS SHRINK TUBE	0.450	M																																										
VM1227A0	GN1613 GASKET JUNCTION PLUG	1	PZ																																										
VM2277A0	DOOR SEAL KIT INTERNAL CONNECTION	1	PZ																																										



COMPONENT			SPARE PART																		
Code	Description	Image	Code	Description	Components list																
TB2684A			TB2684A0																		
TB2685A			KTB1000A	EPDM BLACK TUBE TB1520A 2MT KIT	<table border="1"> <thead> <tr> <th>Code</th> <th>Description</th> <th>Qty</th> <th>UOM</th> </tr> </thead> <tbody> <tr> <td>RC1055A0</td> <td>Ø25-40 H12 STAINLESS STEEL PIPE CLIP</td> <td>2</td> <td>PZ</td> </tr> <tr> <td>TB1520A0</td> <td>INT. Ø=38 TH=4 DRAIN BLACK RUBBER PIPE</td> <td>2</td> <td>M</td> </tr> <tr> <td>VM1059A1</td> <td>HEAT SHRINK FILM H800</td> <td>1.500</td> <td>M</td> </tr> </tbody> </table>	Code	Description	Qty	UOM	RC1055A0	Ø25-40 H12 STAINLESS STEEL PIPE CLIP	2	PZ	TB1520A0	INT. Ø=38 TH=4 DRAIN BLACK RUBBER PIPE	2	M	VM1059A1	HEAT SHRINK FILM H800	1.500	M
Code	Description	Qty	UOM																		
RC1055A0	Ø25-40 H12 STAINLESS STEEL PIPE CLIP	2	PZ																		
TB1520A0	INT. Ø=38 TH=4 DRAIN BLACK RUBBER PIPE	2	M																		
VM1059A1	HEAT SHRINK FILM H800	1.500	M																		
0F1550A	XEVL-20XX EXTERNAL UPPER BACK PLATE		0F1550A0	XEVL-20XX EXTERNAL UPPER BACK PLATE																	
0F1551A	XEVL-20XX EXTERNAL LOWER BACK PLATE		0F1551A0	XEVL-20XX EXTERNAL LOWER BACK PLATE																	
0H8085B	XEVL-20XX CENTRIFUGAL COVER		0H8085B0	XEVL-20XX CENTRIFUGAL COVER																	





COMPONENT			SPARE PART																						
Code	Description	Image	Code	Description	Components list																				
SB1016A	3L DETERGENT TAN		KSB1016A	DETERGENT TANK 3L KIT	<table border="1"> <thead> <tr> <th>Code</th> <th>Description</th> <th>Qty</th> <th>UOM</th> </tr> </thead> <tbody> <tr> <td>IP1385A1</td> <td>CORNER POLYSTYREN E PACKING 110X80X2000</td> <td>1.200</td> <td>M</td> </tr> <tr> <td>IP1410A0</td> <td>POLYSTYREN E PACKING TO PROTECT</td> <td>2</td> <td>PZ</td> </tr> <tr> <td>SB1016A0</td> <td>3L DETERGENT TANK</td> <td>1</td> <td>PZ</td> </tr> <tr> <td>VM1059A1</td> <td>HEAT SHRINK FILM H800</td> <td>1.200</td> <td>M</td> </tr> </tbody> </table>	Code	Description	Qty	UOM	IP1385A1	CORNER POLYSTYREN E PACKING 110X80X2000	1.200	M	IP1410A0	POLYSTYREN E PACKING TO PROTECT	2	PZ	SB1016A0	3L DETERGENT TANK	1	PZ	VM1059A1	HEAT SHRINK FILM H800	1.200	M
Code	Description	Qty	UOM																						
IP1385A1	CORNER POLYSTYREN E PACKING 110X80X2000	1.200	M																						
IP1410A0	POLYSTYREN E PACKING TO PROTECT	2	PZ																						
SB1016A0	3L DETERGENT TANK	1	PZ																						
VM1059A1	HEAT SHRINK FILM H800	1.200	M																						
VM1414A	XEVL-BIG DETERGENT TANK FRAME		VM1414A0	XEVL-BIG DETERGENT TANK FRAME																					
VL1086A	LIMESCALE REMOVER NEODYMIUM MAGNET		KVL1086A	NEODYMIUM MAGNET ANTI-LIMESCALE KI	<table border="1"> <thead> <tr> <th>Code</th> <th>Description</th> <th>Qty</th> <th>UOM</th> </tr> </thead> <tbody> <tr> <td>VL1086A0</td> <td>LIMESCALE REMOVER NEODYMIUM MAGNET</td> <td>2</td> <td>PZ</td> </tr> <tr> <td>VM1224A0</td> <td>65MY 220MM 2 COLOURS SHRINK TUBE</td> <td>0.200</td> <td>M</td> </tr> </tbody> </table>	Code	Description	Qty	UOM	VL1086A0	LIMESCALE REMOVER NEODYMIUM MAGNET	2	PZ	VM1224A0	65MY 220MM 2 COLOURS SHRINK TUBE	0.200	M								
Code	Description	Qty	UOM																						
VL1086A0	LIMESCALE REMOVER NEODYMIUM MAGNET	2	PZ																						
VM1224A0	65MY 220MM 2 COLOURS SHRINK TUBE	0.200	M																						
VL1096A	2PCS T-SHAPED FIT-D6-D10 HOLD-MAGNET		KVL1096A	T - SHAPED FIT-D6-D10 HOLD-2 MAGNETS KIT	<table border="1"> <thead> <tr> <th>Code</th> <th>Description</th> <th>Qty</th> <th>UOM</th> </tr> </thead> <tbody> <tr> <td>RC1018A0</td> <td>ZINC PLATED D12 ELASTIC CLAMP</td> <td>2</td> <td>PZ</td> </tr> <tr> <td>VL1086A0</td> <td>LIMESCALE REMOVER NEODYMIUM MAGNET</td> <td>2</td> <td>PZ</td> </tr> <tr> <td>VL1096A1</td> <td>2PCS T-SHAPED FIT-D6-D10 HOLD-MAGNE</td> <td>1</td> <td>PZ</td> </tr> <tr> <td>VM1224A0</td> <td>65MY 220MM 2 COLOURS SHRINK TUBE</td> <td>0.200</td> <td>M</td> </tr> </tbody> </table>	Code	Description	Qty	UOM	RC1018A0	ZINC PLATED D12 ELASTIC CLAMP	2	PZ	VL1086A0	LIMESCALE REMOVER NEODYMIUM MAGNET	2	PZ	VL1096A1	2PCS T-SHAPED FIT-D6-D10 HOLD-MAGNE	1	PZ	VM1224A0	65MY 220MM 2 COLOURS SHRINK TUBE	0.200	M
Code	Description	Qty	UOM																						
RC1018A0	ZINC PLATED D12 ELASTIC CLAMP	2	PZ																						
VL1086A0	LIMESCALE REMOVER NEODYMIUM MAGNET	2	PZ																						
VL1096A1	2PCS T-SHAPED FIT-D6-D10 HOLD-MAGNE	1	PZ																						
VM1224A0	65MY 220MM 2 COLOURS SHRINK TUBE	0.200	M																						





COMPONENT			SPARE PART																																											
Code	Description	Image	Code	Description	Components list																																									
VM1054A	H7.8 PRESSURE REDUCER RING NUT		KVM1054A	H7.8 PRESSURE REDUCER DIAL KIT	<table border="1"> <thead> <tr> <th>Code</th> <th>Description</th> <th>Qty</th> <th>UOM</th> </tr> </thead> <tbody> <tr> <td>VM1054A0</td> <td>H7.8 PRESSURE REDUCER RING NUT</td> <td>1</td> <td>PZ</td> </tr> <tr> <td>VM1224A0</td> <td>65MY 220MM 2 COLOURS SHRINK TUBE</td> <td>0.200</td> <td>M</td> </tr> </tbody> </table>	Code	Description	Qty	UOM	VM1054A0	H7.8 PRESSURE REDUCER RING NUT	1	PZ	VM1224A0	65MY 220MM 2 COLOURS SHRINK TUBE	0.200	M																													
			Code	Description	Qty	UOM																																								
VM1054A0	H7.8 PRESSURE REDUCER RING NUT	1	PZ																																											
VM1224A0	65MY 220MM 2 COLOURS SHRINK TUBE	0.200	M																																											
KVL1117A	EUR MM 2016+LMT FILTER+PRESS. RED. KIT	<table border="1"> <thead> <tr> <th>Code</th> <th>Description</th> <th>Qty</th> <th>UOM</th> </tr> </thead> <tbody> <tr> <td>0H7472A1</td> <td>DISTRIBUTOR SUPPORT PLATE</td> <td>1</td> <td>PZ</td> </tr> <tr> <td>RC1004A0</td> <td>Ø10-Ø8-8 Y CONNECTION</td> <td>1</td> <td>PZ</td> </tr> <tr> <td>RC1243A0</td> <td>Ø10F-Ø10M ELBOW CONNECTION + JG END KIT</td> <td>1</td> <td>PZ</td> </tr> <tr> <td>RC1372A0</td> <td>Ø10M-1/4 M CIL. STRAIGHT FITTING</td> <td>2</td> <td>PZ</td> </tr> <tr> <td>VI1220A1</td> <td>4,2X12 TCB SELF-TAPPING SCREW</td> <td>4</td> <td>PZ</td> </tr> <tr> <td>VL1014B1</td> <td>PRESSURE REDUCER WITH DISTRIBUTOR</td> <td>1</td> <td>PZ</td> </tr> <tr> <td>VL1014B2</td> <td>PRESSURE REDUCER WITH DISTRIBUTOR</td> <td>1</td> <td>PZ</td> </tr> <tr> <td>VL1034C0</td> <td>MESH WATER FILTER D10</td> <td>1</td> <td>PZ</td> </tr> <tr> <td>VL1062C0</td> <td>PRESSURE REDUCER-FILTER LOCKING FORK</td> <td>1</td> <td>PZ</td> </tr> <tr> <td>VM1054A0</td> <td>H7.8 PRESSURE REDUCER RING NUT</td> <td>1</td> <td>PZ</td> </tr> </tbody> </table>	Code	Description	Qty	UOM	0H7472A1	DISTRIBUTOR SUPPORT PLATE	1	PZ	RC1004A0	Ø10-Ø8-8 Y CONNECTION	1	PZ	RC1243A0	Ø10F-Ø10M ELBOW CONNECTION + JG END KIT	1	PZ	RC1372A0	Ø10M-1/4 M CIL. STRAIGHT FITTING	2	PZ	VI1220A1	4,2X12 TCB SELF-TAPPING SCREW	4	PZ	VL1014B1	PRESSURE REDUCER WITH DISTRIBUTOR	1	PZ	VL1014B2	PRESSURE REDUCER WITH DISTRIBUTOR	1	PZ	VL1034C0	MESH WATER FILTER D10	1	PZ	VL1062C0	PRESSURE REDUCER-FILTER LOCKING FORK	1	PZ	VM1054A0	H7.8 PRESSURE REDUCER RING NUT	1	PZ
Code	Description	Qty	UOM																																											
0H7472A1	DISTRIBUTOR SUPPORT PLATE	1	PZ																																											
RC1004A0	Ø10-Ø8-8 Y CONNECTION	1	PZ																																											
RC1243A0	Ø10F-Ø10M ELBOW CONNECTION + JG END KIT	1	PZ																																											
RC1372A0	Ø10M-1/4 M CIL. STRAIGHT FITTING	2	PZ																																											
VI1220A1	4,2X12 TCB SELF-TAPPING SCREW	4	PZ																																											
VL1014B1	PRESSURE REDUCER WITH DISTRIBUTOR	1	PZ																																											
VL1014B2	PRESSURE REDUCER WITH DISTRIBUTOR	1	PZ																																											
VL1034C0	MESH WATER FILTER D10	1	PZ																																											
VL1062C0	PRESSURE REDUCER-FILTER LOCKING FORK	1	PZ																																											
VM1054A0	H7.8 PRESSURE REDUCER RING NUT	1	PZ																																											
RC1396A	JG D10-1/4 STRAIGHT END FITTING		KVL0014B	EUR 2017 MIND.MAPS PRESSURE REDUCER KIT	<table border="1"> <thead> <tr> <th>Code</th> <th>Description</th> <th>Qty</th> <th>UOM</th> </tr> </thead> <tbody> <tr> <td>RC1372A0</td> <td>Ø10M-1/4 M CIL. STRAIGHT FITTING</td> <td>1</td> <td>PZ</td> </tr> <tr> <td>RC1396A0</td> <td>JG D10-1/4 STRAIGHT END FITTING</td> <td>1</td> <td>PZ</td> </tr> <tr> <td>VL1014B1</td> <td>PRESSURE REDUCER WITH DISTRIBUTOR</td> <td>1</td> <td>PZ</td> </tr> </tbody> </table>	Code	Description	Qty	UOM	RC1372A0	Ø10M-1/4 M CIL. STRAIGHT FITTING	1	PZ	RC1396A0	JG D10-1/4 STRAIGHT END FITTING	1	PZ	VL1014B1	PRESSURE REDUCER WITH DISTRIBUTOR	1	PZ																									
Code	Description	Qty	UOM																																											
RC1372A0	Ø10M-1/4 M CIL. STRAIGHT FITTING	1	PZ																																											
RC1396A0	JG D10-1/4 STRAIGHT END FITTING	1	PZ																																											
VL1014B1	PRESSURE REDUCER WITH DISTRIBUTOR	1	PZ																																											

COMPONENT			SPARE PART																																																										
Code	Description	Image	Code	Description	Components list																																																								
RC1396A	JG D10-1/4 STRAIGHT END FITTING		KVL0014B	EUR 2017 MIND.MAPS PRESSURE REDUCER KIT	<table border="1"> <thead> <tr> <th>Code</th> <th>Description</th> <th>Qty</th> <th>UOM</th> </tr> </thead> <tbody> <tr> <td>VL1014B2</td> <td>PRESSURE REDUCER WITH DISTRIBUTOR</td> <td>1</td> <td>PZ</td> </tr> <tr> <td>VM1054A0</td> <td>H7.8 PRESSURE REDUCER RING NUT</td> <td>1</td> <td>PZ</td> </tr> </tbody> </table>	Code	Description	Qty	UOM	VL1014B2	PRESSURE REDUCER WITH DISTRIBUTOR	1	PZ	VM1054A0	H7.8 PRESSURE REDUCER RING NUT	1	PZ																																												
Code	Description	Qty	UOM																																																										
VL1014B2	PRESSURE REDUCER WITH DISTRIBUTOR	1	PZ																																																										
VM1054A0	H7.8 PRESSURE REDUCER RING NUT	1	PZ																																																										
VL1014B	PRESSURE REDUCER WITH DISTRIBUTOR		<p>KVL0020A</p> <p>KVL0014B</p> <p>KVL0014A</p>	<p>PRESS. REDUCER 03-05XX=OCT18 / MM=MAR19</p> <p>EUR 2017 MIND.MAPS PRESSURE REDUCER KIT</p> <p>EUR MIND.MAPS PRESSURE REDUCER KIT 2016</p>	<table border="1"> <thead> <tr> <th>Code</th> <th>Description</th> <th>Qty</th> <th>UOM</th> </tr> </thead> <tbody> <tr> <td>RC1396A0</td> <td>JG D10-1/4 STRAIGHT END FITTING</td> <td>2</td> <td>PZ</td> </tr> <tr> <td>VL1014B1</td> <td>PRESSURE REDUCER WITH DISTRIBUTOR</td> <td>1</td> <td>PZ</td> </tr> <tr> <td>VL1014B2</td> <td>PRESSURE REDUCER WITH DISTRIBUTOR</td> <td>1</td> <td>PZ</td> </tr> <tr> <td>VM1054A0</td> <td>H7.8 PRESSURE REDUCER RING NUT</td> <td>1</td> <td>PZ</td> </tr> </tbody> </table> <table border="1"> <thead> <tr> <th>Code</th> <th>Description</th> <th>Qty</th> <th>UOM</th> </tr> </thead> <tbody> <tr> <td>RC1372A0</td> <td>Ø10M-1/4 M CIL. STRAIGHT FITTING</td> <td>1</td> <td>PZ</td> </tr> <tr> <td>RC1396A0</td> <td>JG D10-1/4 STRAIGHT END FITTING</td> <td>1</td> <td>PZ</td> </tr> <tr> <td>VL1014B1</td> <td>PRESSURE REDUCER WITH DISTRIBUTOR</td> <td>1</td> <td>PZ</td> </tr> <tr> <td>VL1014B2</td> <td>PRESSURE REDUCER WITH DISTRIBUTOR</td> <td>1</td> <td>PZ</td> </tr> <tr> <td>VM1054A0</td> <td>H7.8 PRESSURE REDUCER RING NUT</td> <td>1</td> <td>PZ</td> </tr> </tbody> </table> <table border="1"> <thead> <tr> <th>Code</th> <th>Description</th> <th>Qty</th> <th>UOM</th> </tr> </thead> <tbody> <tr> <td>RC1372A0</td> <td>Ø10M-1/4 M CIL. STRAIGHT FITTING</td> <td>2</td> <td>PZ</td> </tr> <tr> <td>VL1014B1</td> <td>PRESSURE REDUCER WITH DISTRIBUTOR</td> <td>1</td> <td>PZ</td> </tr> </tbody> </table>	Code	Description	Qty	UOM	RC1396A0	JG D10-1/4 STRAIGHT END FITTING	2	PZ	VL1014B1	PRESSURE REDUCER WITH DISTRIBUTOR	1	PZ	VL1014B2	PRESSURE REDUCER WITH DISTRIBUTOR	1	PZ	VM1054A0	H7.8 PRESSURE REDUCER RING NUT	1	PZ	Code	Description	Qty	UOM	RC1372A0	Ø10M-1/4 M CIL. STRAIGHT FITTING	1	PZ	RC1396A0	JG D10-1/4 STRAIGHT END FITTING	1	PZ	VL1014B1	PRESSURE REDUCER WITH DISTRIBUTOR	1	PZ	VL1014B2	PRESSURE REDUCER WITH DISTRIBUTOR	1	PZ	VM1054A0	H7.8 PRESSURE REDUCER RING NUT	1	PZ	Code	Description	Qty	UOM	RC1372A0	Ø10M-1/4 M CIL. STRAIGHT FITTING	2	PZ	VL1014B1	PRESSURE REDUCER WITH DISTRIBUTOR	1	PZ
Code	Description	Qty	UOM																																																										
RC1396A0	JG D10-1/4 STRAIGHT END FITTING	2	PZ																																																										
VL1014B1	PRESSURE REDUCER WITH DISTRIBUTOR	1	PZ																																																										
VL1014B2	PRESSURE REDUCER WITH DISTRIBUTOR	1	PZ																																																										
VM1054A0	H7.8 PRESSURE REDUCER RING NUT	1	PZ																																																										
Code	Description	Qty	UOM																																																										
RC1372A0	Ø10M-1/4 M CIL. STRAIGHT FITTING	1	PZ																																																										
RC1396A0	JG D10-1/4 STRAIGHT END FITTING	1	PZ																																																										
VL1014B1	PRESSURE REDUCER WITH DISTRIBUTOR	1	PZ																																																										
VL1014B2	PRESSURE REDUCER WITH DISTRIBUTOR	1	PZ																																																										
VM1054A0	H7.8 PRESSURE REDUCER RING NUT	1	PZ																																																										
Code	Description	Qty	UOM																																																										
RC1372A0	Ø10M-1/4 M CIL. STRAIGHT FITTING	2	PZ																																																										
VL1014B1	PRESSURE REDUCER WITH DISTRIBUTOR	1	PZ																																																										

COMPONENT			SPARE PART																																														
Code	Description	Image	Code	Description	Components list																																												
VL1014B	PRESSURE REDUCER WITH DISTRIBUTOR		KVL0014A	EUR MIND.MAPS PRESSURE REDUCER KIT 2016	<table border="1"> <thead> <tr> <th>Code</th> <th>Description</th> <th>Qty</th> <th>UOM</th> </tr> </thead> <tbody> <tr> <td>VL1014B2</td> <td>PRESSURE REDUCER WITH DISTRIBUTOR</td> <td>1</td> <td>PZ</td> </tr> <tr> <td>VM1054A0</td> <td>H7.8 PRESSURE REDUCER RING NUT</td> <td>1</td> <td>PZ</td> </tr> </tbody> </table>	Code	Description	Qty	UOM	VL1014B2	PRESSURE REDUCER WITH DISTRIBUTOR	1	PZ	VM1054A0	H7.8 PRESSURE REDUCER RING NUT	1	PZ																																
			Code	Description	Qty	UOM																																											
VL1014B2	PRESSURE REDUCER WITH DISTRIBUTOR	1	PZ																																														
VM1054A0	H7.8 PRESSURE REDUCER RING NUT	1	PZ																																														
KVL0010A	S.4 - 5 WATER PRESSURE REDUCER KIT	<table border="1"> <thead> <tr> <th>Code</th> <th>Description</th> <th>Qty</th> <th>UOM</th> </tr> </thead> <tbody> <tr> <td>EL1210A0</td> <td>D8-BSP1/4 JG STRAIGHT END CONNECTION</td> <td>2</td> <td>PZ</td> </tr> <tr> <td>VL1014B1</td> <td>PRESSURE REDUCER WITH DISTRIBUTOR</td> <td>1</td> <td>PZ</td> </tr> <tr> <td>VL1014B2</td> <td>PRESSURE REDUCER WITH DISTRIBUTOR</td> <td>1</td> <td>PZ</td> </tr> </tbody> </table>	Code	Description	Qty	UOM	EL1210A0	D8-BSP1/4 JG STRAIGHT END CONNECTION	2	PZ	VL1014B1	PRESSURE REDUCER WITH DISTRIBUTOR	1	PZ	VL1014B2	PRESSURE REDUCER WITH DISTRIBUTOR	1	PZ																															
Code	Description	Qty	UOM																																														
EL1210A0	D8-BSP1/4 JG STRAIGHT END CONNECTION	2	PZ																																														
VL1014B1	PRESSURE REDUCER WITH DISTRIBUTOR	1	PZ																																														
VL1014B2	PRESSURE REDUCER WITH DISTRIBUTOR	1	PZ																																														
RC1243A	Ø10F-Ø10M ELBOW CONNECTION + JG END KIT		KVL1117A	EUR MM 2016+LMT FILTER+PRESS. RED. KIT	<table border="1"> <thead> <tr> <th>Code</th> <th>Description</th> <th>Qty</th> <th>UOM</th> </tr> </thead> <tbody> <tr> <td>0H7472A1</td> <td>DISTRIBUTOR SUPPORT PLATE</td> <td>1</td> <td>PZ</td> </tr> <tr> <td>RC1004A0</td> <td>Ø10-Ø8-8 Y CONNECTION</td> <td>1</td> <td>PZ</td> </tr> <tr> <td>RC1243A0</td> <td>Ø10F-Ø10M ELBOW CONNECTION + JG END KIT</td> <td>1</td> <td>PZ</td> </tr> <tr> <td>RC1372A0</td> <td>Ø10M-1/4 M CIL. STRAIGHT FITTING</td> <td>2</td> <td>PZ</td> </tr> <tr> <td>VI1220A1</td> <td>4,2X12 TCB SELF-TAPPING SCREW</td> <td>4</td> <td>PZ</td> </tr> <tr> <td>VL1014B1</td> <td>PRESSURE REDUCER WITH DISTRIBUTOR</td> <td>1</td> <td>PZ</td> </tr> <tr> <td>VL1014B2</td> <td>PRESSURE REDUCER WITH DISTRIBUTOR</td> <td>1</td> <td>PZ</td> </tr> <tr> <td>VL1034C0</td> <td>MESH WATER FILTER D10</td> <td>1</td> <td>PZ</td> </tr> <tr> <td>VL1062C0</td> <td>PRESSURE REDUCER-FILTER LOCKING FORK</td> <td>1</td> <td>PZ</td> </tr> <tr> <td>VM1054A0</td> <td>H7.8 PRESSURE REDUCER RING NUT</td> <td>1</td> <td>PZ</td> </tr> </tbody> </table>	Code	Description	Qty	UOM	0H7472A1	DISTRIBUTOR SUPPORT PLATE	1	PZ	RC1004A0	Ø10-Ø8-8 Y CONNECTION	1	PZ	RC1243A0	Ø10F-Ø10M ELBOW CONNECTION + JG END KIT	1	PZ	RC1372A0	Ø10M-1/4 M CIL. STRAIGHT FITTING	2	PZ	VI1220A1	4,2X12 TCB SELF-TAPPING SCREW	4	PZ	VL1014B1	PRESSURE REDUCER WITH DISTRIBUTOR	1	PZ	VL1014B2	PRESSURE REDUCER WITH DISTRIBUTOR	1	PZ	VL1034C0	MESH WATER FILTER D10	1	PZ	VL1062C0	PRESSURE REDUCER-FILTER LOCKING FORK	1	PZ	VM1054A0	H7.8 PRESSURE REDUCER RING NUT	1	PZ
			Code	Description	Qty	UOM																																											
			0H7472A1	DISTRIBUTOR SUPPORT PLATE	1	PZ																																											
			RC1004A0	Ø10-Ø8-8 Y CONNECTION	1	PZ																																											
			RC1243A0	Ø10F-Ø10M ELBOW CONNECTION + JG END KIT	1	PZ																																											
			RC1372A0	Ø10M-1/4 M CIL. STRAIGHT FITTING	2	PZ																																											
			VI1220A1	4,2X12 TCB SELF-TAPPING SCREW	4	PZ																																											
			VL1014B1	PRESSURE REDUCER WITH DISTRIBUTOR	1	PZ																																											
			VL1014B2	PRESSURE REDUCER WITH DISTRIBUTOR	1	PZ																																											
			VL1034C0	MESH WATER FILTER D10	1	PZ																																											
VL1062C0	PRESSURE REDUCER-FILTER LOCKING FORK	1	PZ																																														
VM1054A0	H7.8 PRESSURE REDUCER RING NUT	1	PZ																																														

COMPONENT			SPARE PART														
Code	Description	Image	Code	Description	Components list												
RC1243A	Ø10F-Ø10M ELBOW CONNECTION + JG END KIT		KRC1243A	Ø10F-Ø10M ELBOW CONN + JG END 10 PCS KIT	<table border="1"> <thead> <tr> <th>Code</th> <th>Description</th> <th>Qty</th> <th>UOM</th> </tr> </thead> <tbody> <tr> <td>RC1243A0</td> <td>Ø10F-Ø10M ELBOW CONNECTION + JG END KIT</td> <td>10</td> <td>PZ</td> </tr> <tr> <td>VM1224A0</td> <td>65MY 220MM 2 COLOURS SHRINK TUBE</td> <td>0.200</td> <td>M</td> </tr> </tbody> </table>	Code	Description	Qty	UOM	RC1243A0	Ø10F-Ø10M ELBOW CONNECTION + JG END KIT	10	PZ	VM1224A0	65MY 220MM 2 COLOURS SHRINK TUBE	0.200	M
Code	Description	Qty	UOM														
RC1243A0	Ø10F-Ø10M ELBOW CONNECTION + JG END KIT	10	PZ														
VM1224A0	65MY 220MM 2 COLOURS SHRINK TUBE	0.200	M														
VL1135A	3/4-JG10 CONNECTOR + FILTER AND NRV		KVL1135A	3/4-JG10 FITTING WITH FILTER AND VNR KIT	<table border="1"> <thead> <tr> <th>Code</th> <th>Description</th> <th>Qty</th> <th>UOM</th> </tr> </thead> <tbody> <tr> <td>VL1135A0</td> <td>3/4-JG10 CONNECTOR + FILTER AND NRV</td> <td>1</td> <td>PZ</td> </tr> <tr> <td>VM1224A0</td> <td>65MY 220MM 2 COLOURS SHRINK TUBE</td> <td>0.150</td> <td>M</td> </tr> </tbody> </table>	Code	Description	Qty	UOM	VL1135A0	3/4-JG10 CONNECTOR + FILTER AND NRV	1	PZ	VM1224A0	65MY 220MM 2 COLOURS SHRINK TUBE	0.150	M
Code	Description	Qty	UOM														
VL1135A0	3/4-JG10 CONNECTOR + FILTER AND NRV	1	PZ														
VM1224A0	65MY 220MM 2 COLOURS SHRINK TUBE	0.150	M														
TB2699A			TB2699A0														
0H2173A	XEVL PRESSURE REDUCER HOLDER		0H2173A0	XEVL PRESSURE REDUCER HOLDER													
0D2486B	XEVL-2011 RIGHT OPENING LEFT SIDE		0D2486B0	XEVL-2011 RIGHT OPENING LEFT SIDE													

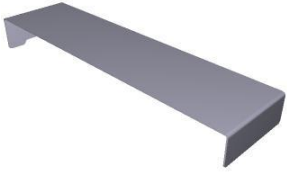





COMPONENT			SPARE PART		
Code	Description	Image	Code	Description	Components list
0D2488B			0D2488B0		
ASM2466A	Support		ASM2466A0	Support	
VM1405A	XEVL BRACKET COVER		VM1405A0	XEVL BRACKET COVER	
0H8031A	BIG UPPER BRACKET COVER		0H8031A0	BIG UPPER BRACKET COVER	
VM2562A	BIG PLATE UPPER BRACKET COVER SUPPORT		VM2562A0	BIG PLATE UPPER BRACKET COVER SUPPORT	



COMPONENT			SPARE PART																																										
Code	Description	Image	Code	Description	Components list																																								
VM2561A	BIG RIGHT DOOR UPPER BRACKET		KVM2561A	BIG-L RIGHT DOOR UPPER BRACKET KI	<table border="1"> <thead> <tr> <th>Code</th> <th>Description</th> <th>Qty</th> <th>UOM</th> </tr> </thead> <tbody> <tr> <td>0H8031A0</td> <td>BIG UPPER BRACKET COVER</td> <td>1</td> <td>PZ</td> </tr> <tr> <td>SL1155A1</td> <td>LOCTITE BICOMPONENT SILICON</td> <td>10</td> <td>ML</td> </tr> <tr> <td>VI1081A0</td> <td>M6X25 STAINLESS STEEL SCREW</td> <td>6</td> <td>PZ</td> </tr> <tr> <td>VI1111A1</td> <td>ST.STEEL TSIC M6X12 SCREW</td> <td>6</td> <td>PZ</td> </tr> <tr> <td>VI1113A0</td> <td>ST.STEEL TCEI M6X12 SCREW</td> <td>6</td> <td>PZ</td> </tr> <tr> <td>VI1521A0</td> <td>STAINLESS STEEL WASHER D=6 6592</td> <td>6</td> <td>PZ</td> </tr> <tr> <td>VM1224A0</td> <td>65MY 220MM 2 COLOURS SHRINK TUBE</td> <td>0.300</td> <td>M</td> </tr> <tr> <td>VM2561A0</td> <td>BIG RIGHT DOOR UPPER BRACKET</td> <td>1</td> <td>PZ</td> </tr> <tr> <td>VM2562A0</td> <td>BIG PLATE UPPER BRACKET COVER SUPPORT</td> <td>1</td> <td>PZ</td> </tr> </tbody> </table>	Code	Description	Qty	UOM	0H8031A0	BIG UPPER BRACKET COVER	1	PZ	SL1155A1	LOCTITE BICOMPONENT SILICON	10	ML	VI1081A0	M6X25 STAINLESS STEEL SCREW	6	PZ	VI1111A1	ST.STEEL TSIC M6X12 SCREW	6	PZ	VI1113A0	ST.STEEL TCEI M6X12 SCREW	6	PZ	VI1521A0	STAINLESS STEEL WASHER D=6 6592	6	PZ	VM1224A0	65MY 220MM 2 COLOURS SHRINK TUBE	0.300	M	VM2561A0	BIG RIGHT DOOR UPPER BRACKET	1	PZ	VM2562A0	BIG PLATE UPPER BRACKET COVER SUPPORT	1	PZ
Code	Description	Qty	UOM																																										
0H8031A0	BIG UPPER BRACKET COVER	1	PZ																																										
SL1155A1	LOCTITE BICOMPONENT SILICON	10	ML																																										
VI1081A0	M6X25 STAINLESS STEEL SCREW	6	PZ																																										
VI1111A1	ST.STEEL TSIC M6X12 SCREW	6	PZ																																										
VI1113A0	ST.STEEL TCEI M6X12 SCREW	6	PZ																																										
VI1521A0	STAINLESS STEEL WASHER D=6 6592	6	PZ																																										
VM1224A0	65MY 220MM 2 COLOURS SHRINK TUBE	0.300	M																																										
VM2561A0	BIG RIGHT DOOR UPPER BRACKET	1	PZ																																										
VM2562A0	BIG PLATE UPPER BRACKET COVER SUPPORT	1	PZ																																										
VI1113A	ST.STEEL TCEI M6X12 SCREW		VI1113A0	ST.STEEL TCEI M6X12 SCREW																																									
RC1378A	HOSE CLAMP		KVE1135A	SERIES 5/5E VENTURI KIT	<table border="1"> <thead> <tr> <th>Code</th> <th>Description</th> <th>Qty</th> <th>UOM</th> </tr> </thead> <tbody> <tr> <td>GN1556A0</td> <td>MM VENTURI SEAL</td> <td>1</td> <td>PZ</td> </tr> <tr> <td>RC1378A0</td> <td>HOSE CLAMP</td> <td>2</td> <td>PZ</td> </tr> <tr> <td>TB1520A0</td> <td>INT. Ø=38 TH=4 DRAIN BLACK RUBBER PIPE</td> <td>0.050</td> <td>M</td> </tr> <tr> <td>VE1135A0</td> <td>220 V 50/60 HZ VENTURI ACTUATOR</td> <td>1</td> <td>PZ</td> </tr> <tr> <td>VI1032A0</td> <td>SCREW M4X16 TCB+ INOX</td> <td>1</td> <td>PZ</td> </tr> </tbody> </table>	Code	Description	Qty	UOM	GN1556A0	MM VENTURI SEAL	1	PZ	RC1378A0	HOSE CLAMP	2	PZ	TB1520A0	INT. Ø=38 TH=4 DRAIN BLACK RUBBER PIPE	0.050	M	VE1135A0	220 V 50/60 HZ VENTURI ACTUATOR	1	PZ	VI1032A0	SCREW M4X16 TCB+ INOX	1	PZ																
Code	Description	Qty	UOM																																										
GN1556A0	MM VENTURI SEAL	1	PZ																																										
RC1378A0	HOSE CLAMP	2	PZ																																										
TB1520A0	INT. Ø=38 TH=4 DRAIN BLACK RUBBER PIPE	0.050	M																																										
VE1135A0	220 V 50/60 HZ VENTURI ACTUATOR	1	PZ																																										
VI1032A0	SCREW M4X16 TCB+ INOX	1	PZ																																										

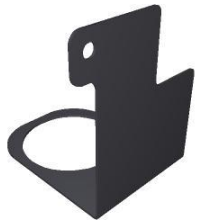
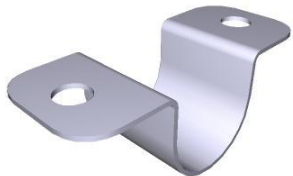



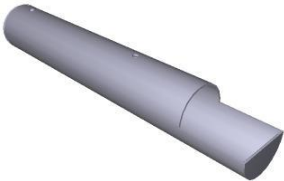
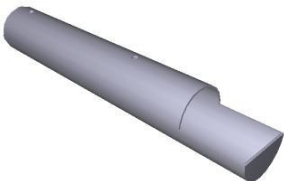

COMPONENT			SPARE PART																																										
Code	Description	Image	Code	Description	Components list																																								
RC1378A	HOSE CLAMP		KVE1135A	SERIES 5/5E VENTURI KIT	<table border="1"> <thead> <tr> <th>Code</th> <th>Description</th> <th>Qty</th> <th>UOM</th> </tr> </thead> <tbody> <tr> <td>VI1511A0</td> <td>STAINLESS STEEL WASHER 4.2X12X1</td> <td>2</td> <td>PZ</td> </tr> <tr> <td>VI1850A0</td> <td>M4X6 NICKEL PLATED FIXING SCREW</td> <td>2</td> <td>PZ</td> </tr> <tr> <td>VI1865A0</td> <td>5X10 TCB+ SELF-THREADI NG SCREW</td> <td>3</td> <td>PZ</td> </tr> <tr> <td>VI1965A0</td> <td>M4X6 CROSS-HEAD ST. STEEL SCREW</td> <td>2</td> <td>PZ</td> </tr> <tr> <td>VM1224A0</td> <td>65MY 220MM 2 COLOURS SHRINK TUBE</td> <td>0.250</td> <td>M</td> </tr> <tr> <td>VM1565B0</td> <td>VENTURI LOWER COIL SUPPORT</td> <td>1</td> <td>PZ</td> </tr> <tr> <td>VM1566A0</td> <td>VENTURI UPPER COIL SUPPORT</td> <td>1</td> <td>PZ</td> </tr> <tr> <td>VM1567A0</td> <td>VENTURI LOWER BUSHING</td> <td>1</td> <td>PZ</td> </tr> <tr> <td>VM1568A0</td> <td>VENTURI PLATE SPACE</td> <td>1</td> <td>PZ</td> </tr> </tbody> </table>	Code	Description	Qty	UOM	VI1511A0	STAINLESS STEEL WASHER 4.2X12X1	2	PZ	VI1850A0	M4X6 NICKEL PLATED FIXING SCREW	2	PZ	VI1865A0	5X10 TCB+ SELF-THREADI NG SCREW	3	PZ	VI1965A0	M4X6 CROSS-HEAD ST. STEEL SCREW	2	PZ	VM1224A0	65MY 220MM 2 COLOURS SHRINK TUBE	0.250	M	VM1565B0	VENTURI LOWER COIL SUPPORT	1	PZ	VM1566A0	VENTURI UPPER COIL SUPPORT	1	PZ	VM1567A0	VENTURI LOWER BUSHING	1	PZ	VM1568A0	VENTURI PLATE SPACE	1	PZ
					Code	Description	Qty	UOM																																					
					VI1511A0	STAINLESS STEEL WASHER 4.2X12X1	2	PZ																																					
					VI1850A0	M4X6 NICKEL PLATED FIXING SCREW	2	PZ																																					
					VI1865A0	5X10 TCB+ SELF-THREADI NG SCREW	3	PZ																																					
					VI1965A0	M4X6 CROSS-HEAD ST. STEEL SCREW	2	PZ																																					
					VM1224A0	65MY 220MM 2 COLOURS SHRINK TUBE	0.250	M																																					
					VM1565B0	VENTURI LOWER COIL SUPPORT	1	PZ																																					
					VM1566A0	VENTURI UPPER COIL SUPPORT	1	PZ																																					
					VM1567A0	VENTURI LOWER BUSHING	1	PZ																																					
VM1568A0	VENTURI PLATE SPACE	1	PZ																																										
VL1026A	BEND FOR DRAIN PIPE		KVL1026A	DRAIN PIPE BEND KI	<table border="1"> <thead> <tr> <th>Code</th> <th>Description</th> <th>Qty</th> <th>UOM</th> </tr> </thead> <tbody> <tr> <td>GN1400A0</td> <td>U-TRAP SEAL</td> <td>1</td> <td>PZ</td> </tr> <tr> <td>VL1026A0</td> <td>BEND FOR DRAIN PIPE</td> <td>1</td> <td>PZ</td> </tr> <tr> <td>VM1224A0</td> <td>65MY 220MM 2 COLOURS SHRINK TUBE</td> <td>0.300</td> <td>M</td> </tr> <tr> <td>VM2039A0</td> <td>DRAIN BEND FIXING RING</td> <td>1</td> <td>PZ</td> </tr> </tbody> </table>	Code	Description	Qty	UOM	GN1400A0	U-TRAP SEAL	1	PZ	VL1026A0	BEND FOR DRAIN PIPE	1	PZ	VM1224A0	65MY 220MM 2 COLOURS SHRINK TUBE	0.300	M	VM2039A0	DRAIN BEND FIXING RING	1	PZ																				
					Code	Description	Qty	UOM																																					
					GN1400A0	U-TRAP SEAL	1	PZ																																					
					VL1026A0	BEND FOR DRAIN PIPE	1	PZ																																					
VM1224A0	65MY 220MM 2 COLOURS SHRINK TUBE	0.300	M																																										
VM2039A0	DRAIN BEND FIXING RING	1	PZ																																										
VM2036A	DRAIN WATER PIPE SUPPORT		KVM2036A	DRAIN WATER PIPE SUPPORT KIT	<table border="1"> <thead> <tr> <th>Code</th> <th>Description</th> <th>Qty</th> <th>UOM</th> </tr> </thead> <tbody> <tr> <td>VI1220A1</td> <td>4,2X12 TCB SELF-TAPPIN G SCREW</td> <td>2</td> <td>PZ</td> </tr> <tr> <td>VM1224A0</td> <td>65MY 220MM 2 COLOURS SHRINK TUBE</td> <td>0.200</td> <td>M</td> </tr> <tr> <td>VM2036A0</td> <td>DRAIN WATER PIPE SUPPOR</td> <td>2</td> <td>PZ</td> </tr> </tbody> </table>	Code	Description	Qty	UOM	VI1220A1	4,2X12 TCB SELF-TAPPIN G SCREW	2	PZ	VM1224A0	65MY 220MM 2 COLOURS SHRINK TUBE	0.200	M	VM2036A0	DRAIN WATER PIPE SUPPOR	2	PZ																								
					Code	Description	Qty	UOM																																					
					VI1220A1	4,2X12 TCB SELF-TAPPIN G SCREW	2	PZ																																					
VM1224A0	65MY 220MM 2 COLOURS SHRINK TUBE	0.200	M																																										
VM2036A0	DRAIN WATER PIPE SUPPOR	2	PZ																																										





COMPONENT			SPARE PART														
Code	Description	Image	Code	Description	Components list												
RC1055A	Ø25-40 H12 STAINLESS STEEL PIPE CLIP		KRC1055A	Ø25-40 PIPE CLAMP 10PCS KIT	<table border="1"> <thead> <tr> <th>Code</th> <th>Description</th> <th>Qty</th> <th>UOM</th> </tr> </thead> <tbody> <tr> <td>RC1055A0</td> <td>Ø25-40 H12 STAINLESS STEEL PIPE CLIP</td> <td>10</td> <td>PZ</td> </tr> <tr> <td>VM1224A0</td> <td>65MY 220MM 2 COLOURS SHRINK TUBE</td> <td>0.250</td> <td>M</td> </tr> </tbody> </table>	Code	Description	Qty	UOM	RC1055A0	Ø25-40 H12 STAINLESS STEEL PIPE CLIP	10	PZ	VM1224A0	65MY 220MM 2 COLOURS SHRINK TUBE	0.250	M
Code	Description	Qty	UOM														
RC1055A0	Ø25-40 H12 STAINLESS STEEL PIPE CLIP	10	PZ														
VM1224A0	65MY 220MM 2 COLOURS SHRINK TUBE	0.250	M														
RC1046A	D10-16 H9 ST STEEL HOSE CLAMP		KTB2237A	1,5M D10 TB2243A CONNECTION PIPE KIT	<table border="1"> <thead> <tr> <th>Code</th> <th>Description</th> <th>Qty</th> <th>UOM</th> </tr> </thead> <tbody> <tr> <td>TB2243A0</td> <td>D10 PE TRANSPAREN T PIPE</td> <td>1.500</td> <td>M</td> </tr> </tbody> </table>	Code	Description	Qty	UOM	TB2243A0	D10 PE TRANSPAREN T PIPE	1.500	M				
Code	Description	Qty	UOM														
TB2243A0	D10 PE TRANSPAREN T PIPE	1.500	M														
0H6567A	P-TRAP HOLDING BRACKET		0H6567A0	P-TRAP HOLDING BRACKET													
0H1045A	BRACKET TO FIX INTERNAL WATER PIPE Ø16		OUTOFPRODUCTIO	ITEM OUT OF PRODUCTION													
0H2166A	TROLLEY DRAIN PIPE HOLDER		0H2166A0	TROLLEY DRAIN PIPE HOLDER													

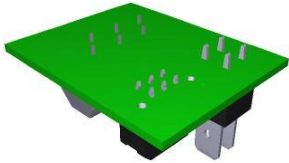

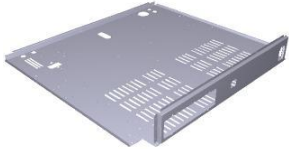



COMPONENT			SPARE PART																		
Code	Description	Image	Code	Description	Components list																
TB3135A	TB1520A-BENDED EPDM BLACK PIPE 90 L64MM		KTB1000A	EPDM BLACK TUBE TB1520A 2MT KIT	<table border="1"> <thead> <tr> <th>Code</th> <th>Description</th> <th>Qty</th> <th>UOM</th> </tr> </thead> <tbody> <tr> <td>RC1055A0</td> <td>Ø25-40 H12 STAINLESS STEEL PIPE CLIP</td> <td>2</td> <td>PZ</td> </tr> <tr> <td>TB1520A0</td> <td>INT. Ø=38 TH=4 DRAIN BLACK RUBBER PIPE</td> <td>2</td> <td>M</td> </tr> <tr> <td>VM1059A1</td> <td>HEAT SHRINK FILM H800</td> <td>1.500</td> <td>M</td> </tr> </tbody> </table>	Code	Description	Qty	UOM	RC1055A0	Ø25-40 H12 STAINLESS STEEL PIPE CLIP	2	PZ	TB1520A0	INT. Ø=38 TH=4 DRAIN BLACK RUBBER PIPE	2	M	VM1059A1	HEAT SHRINK FILM H800	1.500	M
					Code	Description	Qty	UOM													
					RC1055A0	Ø25-40 H12 STAINLESS STEEL PIPE CLIP	2	PZ													
TB1520A0	INT. Ø=38 TH=4 DRAIN BLACK RUBBER PIPE	2	M																		
VM1059A1	HEAT SHRINK FILM H800	1.500	M																		
TB2159A	XEVL-2011 TROLLEY DRAIN PIPE		TB2159A0	XEVL-2011 TROLLEY DRAIN PIPE																	
TB2660A			TB2660A0																		
TB2661A	XEVL-20XX S-SHAPED DRAIN EXTENSION		TB2661A0	XEVL-20XX S-SHAPED DRAIN EXTENSION																	
TB2662A			KTB2662A																		

COMPONENT			SPARE PART																																																						
Code	Description	Image	Code	Description	Components list																																																				
VL1192A	P-TRAP WITH D8 BARBED CONNECTOR		KVL1192A	BIG-L HOSE FITTING U-TRAP KIT	<table border="1"> <thead> <tr> <th>Code</th> <th>Description</th> <th>Qty</th> <th>UOM</th> </tr> </thead> <tbody> <tr> <td>GN1400A0</td> <td>U-TRAP SEAL</td> <td>1</td> <td>PZ</td> </tr> <tr> <td>GN1508A0</td> <td>O-RING GASKET COD 2400</td> <td>1</td> <td>PZ</td> </tr> <tr> <td>SL1170A1</td> <td>S57 BLACK SILICON - 310ML CARTRIDGE</td> <td>5</td> <td>ML</td> </tr> <tr> <td>VI1075A0</td> <td>NUT M4 H=4 UNI5587 INOX</td> <td>4</td> <td>PZ</td> </tr> <tr> <td>VI1895A0</td> <td>BLIND NUT M4 STAINLESS STEEL DIN 917</td> <td>4</td> <td>PZ</td> </tr> <tr> <td>VI1933A0</td> <td></td> <td>1</td> <td>PZ</td> </tr> <tr> <td>VI1945A0</td> <td>ENG-VITE M4X20 TCB+ INOX</td> <td>4</td> <td>PZ</td> </tr> <tr> <td>VL1005A1</td> <td>U-TRAP TANK</td> <td>1</td> <td>PZ</td> </tr> <tr> <td>VL1006A0</td> <td>SYPHON COVER</td> <td>1</td> <td>PZ</td> </tr> <tr> <td>VL1026A0</td> <td>BEND FOR DRAIN PIPE</td> <td>1</td> <td>PZ</td> </tr> <tr> <td>VM1402A0</td> <td></td> <td>1</td> <td>PZ</td> </tr> <tr> <td>VM1446A0</td> <td>U-TRAP TANK AND BARBED VL1004-V0140 5 ASS</td> <td>1</td> <td>PZ</td> </tr> </tbody> </table>	Code	Description	Qty	UOM	GN1400A0	U-TRAP SEAL	1	PZ	GN1508A0	O-RING GASKET COD 2400	1	PZ	SL1170A1	S57 BLACK SILICON - 310ML CARTRIDGE	5	ML	VI1075A0	NUT M4 H=4 UNI5587 INOX	4	PZ	VI1895A0	BLIND NUT M4 STAINLESS STEEL DIN 917	4	PZ	VI1933A0		1	PZ	VI1945A0	ENG-VITE M4X20 TCB+ INOX	4	PZ	VL1005A1	U-TRAP TANK	1	PZ	VL1006A0	SYPHON COVER	1	PZ	VL1026A0	BEND FOR DRAIN PIPE	1	PZ	VM1402A0		1	PZ	VM1446A0	U-TRAP TANK AND BARBED VL1004-V0140 5 ASS	1	PZ
					Code	Description	Qty	UOM																																																	
					GN1400A0	U-TRAP SEAL	1	PZ																																																	
					GN1508A0	O-RING GASKET COD 2400	1	PZ																																																	
					SL1170A1	S57 BLACK SILICON - 310ML CARTRIDGE	5	ML																																																	
					VI1075A0	NUT M4 H=4 UNI5587 INOX	4	PZ																																																	
					VI1895A0	BLIND NUT M4 STAINLESS STEEL DIN 917	4	PZ																																																	
					VI1933A0		1	PZ																																																	
					VI1945A0	ENG-VITE M4X20 TCB+ INOX	4	PZ																																																	
					VL1005A1	U-TRAP TANK	1	PZ																																																	
					VL1006A0	SYPHON COVER	1	PZ																																																	
					VL1026A0	BEND FOR DRAIN PIPE	1	PZ																																																	
					VM1402A0		1	PZ																																																	
VM1446A0	U-TRAP TANK AND BARBED VL1004-V0140 5 ASS	1	PZ																																																						
0H2174A	XEVL-20XX P-TRAP HOLDER		0H2174A0	XEVL-20XX P-TRAP HOLDER																																																					
0H2176A	CORE PROBE BOX COVER		0H2176A0	CORE PROBE BOX COVER																																																					

COMPONENT			SPARE PART																										
Code	Description	Image	Code	Description	Components list																								
PE2142A	4P PROBE JUNCTION CARD		KPE2142A	PT1000 PROBE JUNCTION CARD KI	<table border="1"> <thead> <tr> <th>Code</th> <th>Description</th> <th>Qty</th> <th>UOM</th> </tr> </thead> <tbody> <tr> <td>0H2176A0</td> <td>CORE PROBE BOX COVER</td> <td>1</td> <td>PZ</td> </tr> <tr> <td>PE2142A0</td> <td>4P PROBE JUNCTION CARD</td> <td>1</td> <td>PZ</td> </tr> <tr> <td>VI1074A0</td> <td>4X16 SCREW FOR PLASTIC</td> <td>1</td> <td>PZ</td> </tr> <tr> <td>VI1220A1</td> <td>4,2X12 TCB SELF-TAPPIN G SCREW</td> <td>2</td> <td>PZ</td> </tr> <tr> <td>VM1384A0</td> <td>CORE PROBE TRANSFER BOARD BOX</td> <td>1</td> <td>PZ</td> </tr> </tbody> </table>	Code	Description	Qty	UOM	0H2176A0	CORE PROBE BOX COVER	1	PZ	PE2142A0	4P PROBE JUNCTION CARD	1	PZ	VI1074A0	4X16 SCREW FOR PLASTIC	1	PZ	VI1220A1	4,2X12 TCB SELF-TAPPIN G SCREW	2	PZ	VM1384A0	CORE PROBE TRANSFER BOARD BOX	1	PZ
					Code	Description	Qty	UOM																					
					0H2176A0	CORE PROBE BOX COVER	1	PZ																					
					PE2142A0	4P PROBE JUNCTION CARD	1	PZ																					
					VI1074A0	4X16 SCREW FOR PLASTIC	1	PZ																					
VI1220A1	4,2X12 TCB SELF-TAPPIN G SCREW	2	PZ																										
VM1384A0	CORE PROBE TRANSFER BOARD BOX	1	PZ																										
VM1384A	CORE PROBE TRANSFER BOARD BOX		KPE2142A	PT1000 PROBE JUNCTION CARD KI	<table border="1"> <thead> <tr> <th>Code</th> <th>Description</th> <th>Qty</th> <th>UOM</th> </tr> </thead> <tbody> <tr> <td>0H2176A0</td> <td>CORE PROBE BOX COVER</td> <td>1</td> <td>PZ</td> </tr> <tr> <td>PE2142A0</td> <td>4P PROBE JUNCTION CARD</td> <td>1</td> <td>PZ</td> </tr> <tr> <td>VI1074A0</td> <td>4X16 SCREW FOR PLASTIC</td> <td>1</td> <td>PZ</td> </tr> <tr> <td>VI1220A1</td> <td>4,2X12 TCB SELF-TAPPIN G SCREW</td> <td>2</td> <td>PZ</td> </tr> <tr> <td>VM1384A0</td> <td>CORE PROBE TRANSFER BOARD BOX</td> <td>1</td> <td>PZ</td> </tr> </tbody> </table>	Code	Description	Qty	UOM	0H2176A0	CORE PROBE BOX COVER	1	PZ	PE2142A0	4P PROBE JUNCTION CARD	1	PZ	VI1074A0	4X16 SCREW FOR PLASTIC	1	PZ	VI1220A1	4,2X12 TCB SELF-TAPPIN G SCREW	2	PZ	VM1384A0	CORE PROBE TRANSFER BOARD BOX	1	PZ
					Code	Description	Qty	UOM																					
					0H2176A0	CORE PROBE BOX COVER	1	PZ																					
					PE2142A0	4P PROBE JUNCTION CARD	1	PZ																					
					VI1074A0	4X16 SCREW FOR PLASTIC	1	PZ																					
VI1220A1	4,2X12 TCB SELF-TAPPIN G SCREW	2	PZ																										
VM1384A0	CORE PROBE TRANSFER BOARD BOX	1	PZ																										
CE1975A	L2000MM 6 POLES MICROFIT CABLE		CE1975A0	L2000MM 6 POLES MICROFIT CABLE																									
0E1393B	XEVL-2011-E EXTERNAL BOTTOM PLATE		0E1393B1	XEVL-2011-E EXTERNAL BOTTOM PLATE																									

COMPONENT			SPARE PART																		
Code	Description	Image	Code	Description	Components list																
VL1047A	D6 PIPE HOLDER - D8 J.G. TERMINAL		KVL1047A	Ø6 PIPE HOLDER+Ø8 JG TERMINAL 10 PCS KIT	<table border="1"> <thead> <tr> <th>Code</th> <th>Description</th> <th>Qty</th> <th>UOM</th> </tr> </thead> <tbody> <tr> <td>VL1047A1</td> <td>D6 PIPE HOLDER - D8 J.G. TERMINAL</td> <td>10</td> <td>PZ</td> </tr> <tr> <td>VM1224A0</td> <td>65MY 220MM 2 COLOURS SHRINK TUBE</td> <td>0.200</td> <td>M</td> </tr> </tbody> </table>	Code	Description	Qty	UOM	VL1047A1	D6 PIPE HOLDER - D8 J.G. TERMINAL	10	PZ	VM1224A0	65MY 220MM 2 COLOURS SHRINK TUBE	0.200	M				
			Code	Description	Qty	UOM															
VL1047A1	D6 PIPE HOLDER - D8 J.G. TERMINAL	10	PZ																		
VM1224A0	65MY 220MM 2 COLOURS SHRINK TUBE	0.200	M																		
KVL0016A	BRITA ADAPTOR KIT FOR MM CLEANING SYSTEM	<table border="1"> <thead> <tr> <th>Code</th> <th>Description</th> <th>Qty</th> <th>UOM</th> </tr> </thead> <tbody> <tr> <td>EL1185A0</td> <td>Ø8F - Ø8F ELBOW CONNECTION</td> <td>260</td> <td>PZ</td> </tr> <tr> <td>RC1018A0</td> <td>ZINC PLATED D12 ELASTIC CLAMP</td> <td>520</td> <td>PZ</td> </tr> <tr> <td>VL1047A1</td> <td>D6 PIPE HOLDER - D8 J.G. TERMINAL</td> <td>520</td> <td>PZ</td> </tr> </tbody> </table>	Code	Description	Qty	UOM	EL1185A0	Ø8F - Ø8F ELBOW CONNECTION	260	PZ	RC1018A0	ZINC PLATED D12 ELASTIC CLAMP	520	PZ	VL1047A1	D6 PIPE HOLDER - D8 J.G. TERMINAL	520	PZ			
Code	Description	Qty	UOM																		
EL1185A0	Ø8F - Ø8F ELBOW CONNECTION	260	PZ																		
RC1018A0	ZINC PLATED D12 ELASTIC CLAMP	520	PZ																		
VL1047A1	D6 PIPE HOLDER - D8 J.G. TERMINAL	520	PZ																		
VL1095A	D7.8-D10 RUBBER HOLDER M-M FITTIN		KVL1095A	STRAIGHT CONNECT-HOLDER D7-D10 10PCS KIT	<table border="1"> <thead> <tr> <th>Code</th> <th>Description</th> <th>Qty</th> <th>UOM</th> </tr> </thead> <tbody> <tr> <td>VL1095A0</td> <td>D7.8-D10 RUBBER HOLDER M-M FITTING</td> <td>10</td> <td>PZ</td> </tr> <tr> <td>VM1224A0</td> <td>65MY 220MM 2 COLOURS SHRINK TUBE</td> <td>0.200</td> <td>M</td> </tr> </tbody> </table>	Code	Description	Qty	UOM	VL1095A0	D7.8-D10 RUBBER HOLDER M-M FITTING	10	PZ	VM1224A0	65MY 220MM 2 COLOURS SHRINK TUBE	0.200	M				
			Code	Description	Qty	UOM															
VL1095A0	D7.8-D10 RUBBER HOLDER M-M FITTING	10	PZ																		
VM1224A0	65MY 220MM 2 COLOURS SHRINK TUBE	0.200	M																		
EL1432A	STEAM SOLENOID VALVE 9+67 JG D8-D10		KEL1432A	9+67 STEAM SOLENOID VALVE KI	<table border="1"> <thead> <tr> <th>Code</th> <th>Description</th> <th>Qty</th> <th>UOM</th> </tr> </thead> <tbody> <tr> <td>EL1432A0</td> <td>STEAM SOLENOID VALVE 9+67 JG D8-D10</td> <td>1</td> <td>PZ</td> </tr> <tr> <td>MOV0004A0</td> <td>HOOD RING GASKET GN1110A2</td> <td>0.100</td> <td>PZ</td> </tr> <tr> <td>VM1224A0</td> <td>65MY 220MM 2 COLOURS SHRINK TUBE</td> <td>0.250</td> <td>M</td> </tr> </tbody> </table>	Code	Description	Qty	UOM	EL1432A0	STEAM SOLENOID VALVE 9+67 JG D8-D10	1	PZ	MOV0004A0	HOOD RING GASKET GN1110A2	0.100	PZ	VM1224A0	65MY 220MM 2 COLOURS SHRINK TUBE	0.250	M
Code	Description	Qty	UOM																		
EL1432A0	STEAM SOLENOID VALVE 9+67 JG D8-D10	1	PZ																		
MOV0004A0	HOOD RING GASKET GN1110A2	0.100	PZ																		
VM1224A0	65MY 220MM 2 COLOURS SHRINK TUBE	0.250	M																		
RC1414A	D12 HOSE CLAMP		RC1414A0	D12 HOSE CLAMP																	



COMPONENT			SPARE PART														
Code	Description	Image	Code	Description	Components list												
TB2700A			TB2700A0														
TB3234A			TB3234A0														
VL1184A			VL1184A2														
GN1526A	INT. D.=6.9 TH=1.8 O-RING		KGN1526A	O-RING INT D6.9 THICK1.8 10PCS KIT	<table border="1"> <thead> <tr> <th>Code</th> <th>Description</th> <th>Qty</th> <th>UOM</th> </tr> </thead> <tbody> <tr> <td>GN1526A0</td> <td>INT. D.=6.9 TH=1.8 O-RIN</td> <td>10</td> <td>PZ</td> </tr> </tbody> </table>	Code	Description	Qty	UOM	GN1526A0	INT. D.=6.9 TH=1.8 O-RIN	10	PZ				
Code	Description	Qty	UOM														
GN1526A0	INT. D.=6.9 TH=1.8 O-RIN	10	PZ														
RC1019A	D=10 ELASTIC CLAM		KRC1019A	Ø10 ZINC PLATED ELASTIC CLAMP 15 PCS KIT	<table border="1"> <thead> <tr> <th>Code</th> <th>Description</th> <th>Qty</th> <th>UOM</th> </tr> </thead> <tbody> <tr> <td>RC1019A0</td> <td>D=10 ELASTIC CLAMP</td> <td>17</td> <td>PZ</td> </tr> <tr> <td>VM1224A0</td> <td>65MY 220MM 2 COLOURS SHRINK TUBE</td> <td>0.200</td> <td>M</td> </tr> </tbody> </table>	Code	Description	Qty	UOM	RC1019A0	D=10 ELASTIC CLAMP	17	PZ	VM1224A0	65MY 220MM 2 COLOURS SHRINK TUBE	0.200	M
Code	Description	Qty	UOM														
RC1019A0	D=10 ELASTIC CLAMP	17	PZ														
VM1224A0	65MY 220MM 2 COLOURS SHRINK TUBE	0.200	M														

COMPONENT			SPARE PART																						
Code	Description	Image	Code	Description	Components list																				
VL1102A	DETERGENT LINE FILTER + BARBED VNR 6 MM		KVL1102A	DETERGENT FILTER + NRV KIT	<table border="1"> <thead> <tr> <th>Code</th> <th>Description</th> <th>Qty</th> <th>UOM</th> </tr> </thead> <tbody> <tr> <td>RC1019A0</td> <td>D=10 ELASTIC CLAMP</td> <td>5</td> <td>PZ</td> </tr> <tr> <td>TB2820A0</td> <td>6X10 EPDM PIPE FOR WASHING SYSTEM</td> <td>0.710</td> <td>M</td> </tr> <tr> <td>VL1102A1</td> <td>DETERGENT LINE FILTER + BARBED VNR 6 MM</td> <td>1</td> <td>PZ</td> </tr> <tr> <td>VM1224A0</td> <td>65MY 220MM 2 COLOURS SHRINK TUBE</td> <td>0.300</td> <td>M</td> </tr> </tbody> </table>	Code	Description	Qty	UOM	RC1019A0	D=10 ELASTIC CLAMP	5	PZ	TB2820A0	6X10 EPDM PIPE FOR WASHING SYSTEM	0.710	M	VL1102A1	DETERGENT LINE FILTER + BARBED VNR 6 MM	1	PZ	VM1224A0	65MY 220MM 2 COLOURS SHRINK TUBE	0.300	M
Code	Description	Qty	UOM																						
RC1019A0	D=10 ELASTIC CLAMP	5	PZ																						
TB2820A0	6X10 EPDM PIPE FOR WASHING SYSTEM	0.710	M																						
VL1102A1	DETERGENT LINE FILTER + BARBED VNR 6 MM	1	PZ																						
VM1224A0	65MY 220MM 2 COLOURS SHRINK TUBE	0.300	M																						
TB3004A	TB2820A L=550MM EPDM BLACK PIPE		KTB1343A	TB2820A0 6X10 EPM PIPE 3M KIT	<table border="1"> <thead> <tr> <th>Code</th> <th>Description</th> <th>Qty</th> <th>UOM</th> </tr> </thead> <tbody> <tr> <td>TB2820A0</td> <td>6X10 EPDM PIPE FOR WASHING SYSTEM</td> <td>3</td> <td>M</td> </tr> </tbody> </table>	Code	Description	Qty	UOM	TB2820A0	6X10 EPDM PIPE FOR WASHING SYSTEM	3	M												
Code	Description	Qty	UOM																						
TB2820A0	6X10 EPDM PIPE FOR WASHING SYSTEM	3	M																						
TB3005B	TB3132A L=550MM EPDM WHITE-BLUE PIPE		KTB3132A	WHITE-BLU 6X12 REINFORCED PIPE 3M KIT	<table border="1"> <thead> <tr> <th>Code</th> <th>Description</th> <th>Qty</th> <th>UOM</th> </tr> </thead> <tbody> <tr> <td>TB3132A0</td> <td>WHITE-BLUE EPDM TEXTILE BRAID HOSE 6X12</td> <td>3</td> <td>M</td> </tr> <tr> <td>VM1794A0</td> <td>250X4.8 PA66 BLACK CLAMP</td> <td>1</td> <td>PZ</td> </tr> </tbody> </table>	Code	Description	Qty	UOM	TB3132A0	WHITE-BLUE EPDM TEXTILE BRAID HOSE 6X12	3	M	VM1794A0	250X4.8 PA66 BLACK CLAMP	1	PZ								
Code	Description	Qty	UOM																						
TB3132A0	WHITE-BLUE EPDM TEXTILE BRAID HOSE 6X12	3	M																						
VM1794A0	250X4.8 PA66 BLACK CLAMP	1	PZ																						
0H2354A	XEVC-XEVL WASHING CIRCUIT PLATE		0H2354A0	XEVC-XEVL WASHING CIRCUIT PLATE																					
TB2994A	HOOD DETERGENT PIPE		TB2994A0	HOOD DETERGENT PIPE																					

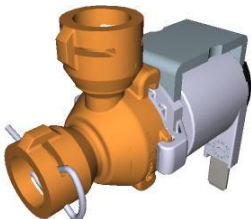
COMPONENT			SPARE PART																																																																						
Code	Description	Image	Code	Description	Components list																																																																				
TB3440A	TB3132A L=1050MM EPDM WHITE-BLUE PIPE		TB3440A0	TB3132A L=1050MM EPDM WHITE-BLUE PIPE																																																																					
EL1440A	WATER SELF CLEANING VALVE		KVL1187A	3 ROTOR ARMS PLUS EU CLEANING SYSTEM KIT	<table border="1"> <thead> <tr> <th>Code</th> <th>Description</th> <th>Qty</th> <th>UOM</th> </tr> </thead> <tbody> <tr> <td>0H2143A0</td> <td>LAMIERA BLOCCA VNR VL1128</td> <td>3</td> <td>PZ</td> </tr> <tr> <td>0H2168A0</td> <td></td> <td>1</td> <td>PZ</td> </tr> <tr> <td>0H2354A0</td> <td>XEVC-XEVL WASHING CIRCUIT PLAT</td> <td>1</td> <td>PZ</td> </tr> <tr> <td>EL1120A0</td> <td>D8-D6 FEMALE STRAIGHT INTERM. CONNECTION</td> <td>1</td> <td>PZ</td> </tr> <tr> <td>EL1220A0</td> <td>JG STRAIGHT CONNECTION Ø8F-Ø8F</td> <td>2</td> <td>PZ</td> </tr> <tr> <td>EL1440A0</td> <td>WATER SELF CLEANING VALVE</td> <td>4</td> <td>PZ</td> </tr> <tr> <td>GN1526A0</td> <td>INT. D.=6.9 TH=1.8 O-RING</td> <td>9</td> <td>PZ</td> </tr> <tr> <td>RC1018A0</td> <td>ZINC PLATED D12 ELASTIC CLAMP</td> <td>10</td> <td>PZ</td> </tr> <tr> <td>RC1019A0</td> <td>D=10 ELASTIC CLAMP</td> <td>22</td> <td>PZ</td> </tr> <tr> <td>RC1130A0</td> <td>130X2,6 CLAM</td> <td>4</td> <td>PZ</td> </tr> <tr> <td>RC1131A0</td> <td>200X2.6 BLACK CLAMP</td> <td>3</td> <td>PZ</td> </tr> <tr> <td>RC1242A0</td> <td>D=10 CLOSED CAP</td> <td>2</td> <td>PZ</td> </tr> <tr> <td>RC1310A0</td> <td>140X4 CLAMP WITH CLIP</td> <td>1</td> <td>PZ</td> </tr> <tr> <td>RC1356A0</td> <td>"STRAIGHT THREADED FEMALE END 8X1/4" BS</td> <td>1</td> <td>PZ</td> </tr> <tr> <td>TB2820A0</td> <td>6X10 EPDM PIPE FOR WASHING SYSTEM</td> <td>1.510</td> <td>M</td> </tr> <tr> <td>TB3132A0</td> <td>WHITE-BLUE EPDM TEXTILE BRAID HOSE 6X12</td> <td>1.210</td> <td>M</td> </tr> </tbody> </table>	Code	Description	Qty	UOM	0H2143A0	LAMIERA BLOCCA VNR VL1128	3	PZ	0H2168A0		1	PZ	0H2354A0	XEVC-XEVL WASHING CIRCUIT PLAT	1	PZ	EL1120A0	D8-D6 FEMALE STRAIGHT INTERM. CONNECTION	1	PZ	EL1220A0	JG STRAIGHT CONNECTION Ø8F-Ø8F	2	PZ	EL1440A0	WATER SELF CLEANING VALVE	4	PZ	GN1526A0	INT. D.=6.9 TH=1.8 O-RING	9	PZ	RC1018A0	ZINC PLATED D12 ELASTIC CLAMP	10	PZ	RC1019A0	D=10 ELASTIC CLAMP	22	PZ	RC1130A0	130X2,6 CLAM	4	PZ	RC1131A0	200X2.6 BLACK CLAMP	3	PZ	RC1242A0	D=10 CLOSED CAP	2	PZ	RC1310A0	140X4 CLAMP WITH CLIP	1	PZ	RC1356A0	"STRAIGHT THREADED FEMALE END 8X1/4" BS	1	PZ	TB2820A0	6X10 EPDM PIPE FOR WASHING SYSTEM	1.510	M	TB3132A0	WHITE-BLUE EPDM TEXTILE BRAID HOSE 6X12	1.210	M
Code	Description	Qty	UOM																																																																						
0H2143A0	LAMIERA BLOCCA VNR VL1128	3	PZ																																																																						
0H2168A0		1	PZ																																																																						
0H2354A0	XEVC-XEVL WASHING CIRCUIT PLAT	1	PZ																																																																						
EL1120A0	D8-D6 FEMALE STRAIGHT INTERM. CONNECTION	1	PZ																																																																						
EL1220A0	JG STRAIGHT CONNECTION Ø8F-Ø8F	2	PZ																																																																						
EL1440A0	WATER SELF CLEANING VALVE	4	PZ																																																																						
GN1526A0	INT. D.=6.9 TH=1.8 O-RING	9	PZ																																																																						
RC1018A0	ZINC PLATED D12 ELASTIC CLAMP	10	PZ																																																																						
RC1019A0	D=10 ELASTIC CLAMP	22	PZ																																																																						
RC1130A0	130X2,6 CLAM	4	PZ																																																																						
RC1131A0	200X2.6 BLACK CLAMP	3	PZ																																																																						
RC1242A0	D=10 CLOSED CAP	2	PZ																																																																						
RC1310A0	140X4 CLAMP WITH CLIP	1	PZ																																																																						
RC1356A0	"STRAIGHT THREADED FEMALE END 8X1/4" BS	1	PZ																																																																						
TB2820A0	6X10 EPDM PIPE FOR WASHING SYSTEM	1.510	M																																																																						
TB3132A0	WHITE-BLUE EPDM TEXTILE BRAID HOSE 6X12	1.210	M																																																																						

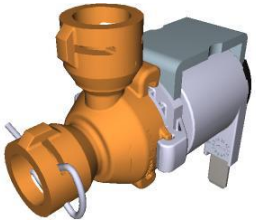
COMPONENT			SPARE PART																																																																																		
Code	Description	Image	Code	Description	Components list																																																																																
EL1440A	WATER SELF CLEANING VALVE		KVL1187A	3 ROTOR ARMS PLUS EU CLEANING SYSTEM KIT	<table border="1"> <thead> <tr> <th>Code</th> <th>Description</th> <th>Qty</th> <th>UOM</th> </tr> </thead> <tbody> <tr> <td>VI1220A1</td> <td>4,2X12 TCB SELF-TAPPIN G SCREW</td> <td>3</td> <td>PZ</td> </tr> <tr> <td>VL1019A0</td> <td>VIBRATION PUMP</td> <td>1</td> <td>PZ</td> </tr> <tr> <td>VL1046A1</td> <td>D6 PIPE HOLDER - D6 J.G. TERMINAL</td> <td>3</td> <td>PZ</td> </tr> <tr> <td>VL1047A1</td> <td>D6 PIPE HOLDER - D8 J.G. TERMINAL</td> <td>1</td> <td>PZ</td> </tr> <tr> <td>VL1064A0</td> <td>WASHING SYSTEM OUTLETS DISTRIBUTOR</td> <td>1</td> <td>PZ</td> </tr> <tr> <td>VL1065A1</td> <td>1/4 MALE N.O. PRESSURE SWITCH</td> <td>1</td> <td>PZ</td> </tr> <tr> <td>VL1067A0</td> <td>WASHING SYSTEM INLETS DISTRIBUTOR</td> <td>1</td> <td>PZ</td> </tr> <tr> <td>VL1092A0</td> <td>WASHING SYSTEM OUTLET DOUBLE DISTRIBUTOR</td> <td>1</td> <td>PZ</td> </tr> <tr> <td>VL1102A1</td> <td>DETERGENT LINE FILTER + BARBED VNR 6 MM</td> <td>1</td> <td>PZ</td> </tr> <tr> <td>VL1127A1</td> <td>6MM BARBED T-SHAPED FITTING</td> <td>2</td> <td>PZ</td> </tr> <tr> <td>VL1128A0</td> <td>D6 BARBED CHECK VALVE</td> <td>3</td> <td>PZ</td> </tr> <tr> <td>VL1128A1</td> <td>D6 BARBED CHECK VALVE</td> <td>3</td> <td>PZ</td> </tr> <tr> <td>VL1165A0</td> <td>BB6-AR6 STRAIGHT FITTING</td> <td>4</td> <td>PZ</td> </tr> <tr> <td>VL1166A0</td> <td>BB6-AR6 L FITTING</td> <td>4</td> <td>PZ</td> </tr> <tr> <td>VL1167A0</td> <td></td> <td>1</td> <td>PZ</td> </tr> <tr> <td>VL1167A1</td> <td></td> <td>1</td> <td>PZ</td> </tr> <tr> <td>VL1167A2</td> <td>GN21 3 ROTOR ARMS B-B FLOW RESTRICTOR</td> <td>1</td> <td>PZ</td> </tr> <tr> <td>VL1174C0</td> <td>D1.2 MM CALIBRATED NOZZLE</td> <td>1</td> <td>PZ</td> </tr> <tr> <td>VL1185A0</td> <td>2 WAYS PLUS WASHING DISTRIBUTOR</td> <td>1</td> <td>PZ</td> </tr> </tbody> </table>	Code	Description	Qty	UOM	VI1220A1	4,2X12 TCB SELF-TAPPIN G SCREW	3	PZ	VL1019A0	VIBRATION PUMP	1	PZ	VL1046A1	D6 PIPE HOLDER - D6 J.G. TERMINAL	3	PZ	VL1047A1	D6 PIPE HOLDER - D8 J.G. TERMINAL	1	PZ	VL1064A0	WASHING SYSTEM OUTLETS DISTRIBUTOR	1	PZ	VL1065A1	1/4 MALE N.O. PRESSURE SWITCH	1	PZ	VL1067A0	WASHING SYSTEM INLETS DISTRIBUTOR	1	PZ	VL1092A0	WASHING SYSTEM OUTLET DOUBLE DISTRIBUTOR	1	PZ	VL1102A1	DETERGENT LINE FILTER + BARBED VNR 6 MM	1	PZ	VL1127A1	6MM BARBED T-SHAPED FITTING	2	PZ	VL1128A0	D6 BARBED CHECK VALVE	3	PZ	VL1128A1	D6 BARBED CHECK VALVE	3	PZ	VL1165A0	BB6-AR6 STRAIGHT FITTING	4	PZ	VL1166A0	BB6-AR6 L FITTING	4	PZ	VL1167A0		1	PZ	VL1167A1		1	PZ	VL1167A2	GN21 3 ROTOR ARMS B-B FLOW RESTRICTOR	1	PZ	VL1174C0	D1.2 MM CALIBRATED NOZZLE	1	PZ	VL1185A0	2 WAYS PLUS WASHING DISTRIBUTOR	1	PZ
Code	Description	Qty	UOM																																																																																		
VI1220A1	4,2X12 TCB SELF-TAPPIN G SCREW	3	PZ																																																																																		
VL1019A0	VIBRATION PUMP	1	PZ																																																																																		
VL1046A1	D6 PIPE HOLDER - D6 J.G. TERMINAL	3	PZ																																																																																		
VL1047A1	D6 PIPE HOLDER - D8 J.G. TERMINAL	1	PZ																																																																																		
VL1064A0	WASHING SYSTEM OUTLETS DISTRIBUTOR	1	PZ																																																																																		
VL1065A1	1/4 MALE N.O. PRESSURE SWITCH	1	PZ																																																																																		
VL1067A0	WASHING SYSTEM INLETS DISTRIBUTOR	1	PZ																																																																																		
VL1092A0	WASHING SYSTEM OUTLET DOUBLE DISTRIBUTOR	1	PZ																																																																																		
VL1102A1	DETERGENT LINE FILTER + BARBED VNR 6 MM	1	PZ																																																																																		
VL1127A1	6MM BARBED T-SHAPED FITTING	2	PZ																																																																																		
VL1128A0	D6 BARBED CHECK VALVE	3	PZ																																																																																		
VL1128A1	D6 BARBED CHECK VALVE	3	PZ																																																																																		
VL1165A0	BB6-AR6 STRAIGHT FITTING	4	PZ																																																																																		
VL1166A0	BB6-AR6 L FITTING	4	PZ																																																																																		
VL1167A0		1	PZ																																																																																		
VL1167A1		1	PZ																																																																																		
VL1167A2	GN21 3 ROTOR ARMS B-B FLOW RESTRICTOR	1	PZ																																																																																		
VL1174C0	D1.2 MM CALIBRATED NOZZLE	1	PZ																																																																																		
VL1185A0	2 WAYS PLUS WASHING DISTRIBUTOR	1	PZ																																																																																		

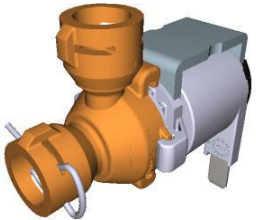
COMPONENT			SPARE PART																																																															
Code	Description	Image	Code	Description	Components list																																																													
EL1440A	WATER SELF CLEANING VALVE		KVL1187A	3 ROTOR ARMS PLUS EU CLEANING SYSTEM KIT	<table border="1"> <thead> <tr> <th>Code</th> <th>Description</th> <th>Qty</th> <th>UOM</th> </tr> </thead> <tbody> <tr> <td>VL1186A0</td> <td>3 WAYS PLUS WASHING DISTRIBUTOR</td> <td>1</td> <td>PZ</td> </tr> <tr> <td>VL1190A0</td> <td>PLUS WASHING SYSTEM INLET DISTRIBUTOR</td> <td>1</td> <td>PZ</td> </tr> <tr> <td>VM1605A0</td> <td>CLIP TWIST LOCK DIAM. 10,2-12,7 MM</td> <td>3</td> <td>PZ</td> </tr> <tr> <td>VM2172A0</td> <td>PUMP-WITH-CI RCUIT LOCKING PIN</td> <td>9</td> <td>PZ</td> </tr> </tbody> </table>	Code	Description	Qty	UOM	VL1186A0	3 WAYS PLUS WASHING DISTRIBUTOR	1	PZ	VL1190A0	PLUS WASHING SYSTEM INLET DISTRIBUTOR	1	PZ	VM1605A0	CLIP TWIST LOCK DIAM. 10,2-12,7 MM	3	PZ	VM2172A0	PUMP-WITH-CI RCUIT LOCKING PIN	9	PZ																																									
			Code	Description	Qty	UOM																																																												
VL1186A0	3 WAYS PLUS WASHING DISTRIBUTOR	1	PZ																																																															
VL1190A0	PLUS WASHING SYSTEM INLET DISTRIBUTOR	1	PZ																																																															
VM1605A0	CLIP TWIST LOCK DIAM. 10,2-12,7 MM	3	PZ																																																															
VM2172A0	PUMP-WITH-CI RCUIT LOCKING PIN	9	PZ																																																															
KVL1184A	2 ROTOR ARMS PLUS EU CLEANING SYSTEM KIT	<table border="1"> <thead> <tr> <th>Code</th> <th>Description</th> <th>Qty</th> <th>UOM</th> </tr> </thead> <tbody> <tr> <td>0H2143A0</td> <td>LAMIERA BLOCCA VNR VL1128</td> <td>2</td> <td>PZ</td> </tr> <tr> <td>0H2168A0</td> <td></td> <td>1</td> <td>PZ</td> </tr> <tr> <td>0H2354A0</td> <td>XEVC-XEVL WASHING CIRCUIT PLAT</td> <td>1</td> <td>PZ</td> </tr> <tr> <td>EL1220A0</td> <td>JG STRAIGHT CONNECTION Ø8F-Ø8F</td> <td>3</td> <td>PZ</td> </tr> <tr> <td>EL1440A0</td> <td>WATER SELF CLEANING VALVE</td> <td>4</td> <td>PZ</td> </tr> <tr> <td>GN1526A0</td> <td>INT. D.=6.9 TH=1.8 O-RIN</td> <td>9</td> <td>PZ</td> </tr> <tr> <td>RC1018A0</td> <td>ZINC PLATED D12 ELASTIC CLAMP</td> <td>2</td> <td>PZ</td> </tr> <tr> <td>RC1019A0</td> <td>D=10 ELASTIC CLAMP</td> <td>21</td> <td>PZ</td> </tr> <tr> <td>RC1130A0</td> <td>130X2,6 CLAM</td> <td>7</td> <td>PZ</td> </tr> <tr> <td>RC1131A0</td> <td>200X2.6 BLACK CLAMP</td> <td>3</td> <td>PZ</td> </tr> <tr> <td>RC1242A0</td> <td>D=10 CLOSED CAP</td> <td>2</td> <td>PZ</td> </tr> <tr> <td>RC1356A0</td> <td>"STRAIGHT THREADED FEMALE END 8X1/4" BS</td> <td>1</td> <td>PZ</td> </tr> <tr> <td>TB2820A0</td> <td>6X10 EPDM PIPE FOR WASHING SYSTEM</td> <td>2.400</td> <td>M</td> </tr> <tr> <td>TB3132A0</td> <td>WHITE-BLUE EPDM TEXTILE BRAID HOSE 6X12</td> <td>1.220</td> <td>M</td> </tr> <tr> <td>VL1019A0</td> <td>VIBRATION PUMP</td> <td>1</td> <td>PZ</td> </tr> </tbody> </table>	Code	Description	Qty	UOM	0H2143A0	LAMIERA BLOCCA VNR VL1128	2	PZ	0H2168A0		1	PZ	0H2354A0	XEVC-XEVL WASHING CIRCUIT PLAT	1	PZ	EL1220A0	JG STRAIGHT CONNECTION Ø8F-Ø8F	3	PZ	EL1440A0	WATER SELF CLEANING VALVE	4	PZ	GN1526A0	INT. D.=6.9 TH=1.8 O-RIN	9	PZ	RC1018A0	ZINC PLATED D12 ELASTIC CLAMP	2	PZ	RC1019A0	D=10 ELASTIC CLAMP	21	PZ	RC1130A0	130X2,6 CLAM	7	PZ	RC1131A0	200X2.6 BLACK CLAMP	3	PZ	RC1242A0	D=10 CLOSED CAP	2	PZ	RC1356A0	"STRAIGHT THREADED FEMALE END 8X1/4" BS	1	PZ	TB2820A0	6X10 EPDM PIPE FOR WASHING SYSTEM	2.400	M	TB3132A0	WHITE-BLUE EPDM TEXTILE BRAID HOSE 6X12	1.220	M	VL1019A0	VIBRATION PUMP	1	PZ
Code	Description	Qty	UOM																																																															
0H2143A0	LAMIERA BLOCCA VNR VL1128	2	PZ																																																															
0H2168A0		1	PZ																																																															
0H2354A0	XEVC-XEVL WASHING CIRCUIT PLAT	1	PZ																																																															
EL1220A0	JG STRAIGHT CONNECTION Ø8F-Ø8F	3	PZ																																																															
EL1440A0	WATER SELF CLEANING VALVE	4	PZ																																																															
GN1526A0	INT. D.=6.9 TH=1.8 O-RIN	9	PZ																																																															
RC1018A0	ZINC PLATED D12 ELASTIC CLAMP	2	PZ																																																															
RC1019A0	D=10 ELASTIC CLAMP	21	PZ																																																															
RC1130A0	130X2,6 CLAM	7	PZ																																																															
RC1131A0	200X2.6 BLACK CLAMP	3	PZ																																																															
RC1242A0	D=10 CLOSED CAP	2	PZ																																																															
RC1356A0	"STRAIGHT THREADED FEMALE END 8X1/4" BS	1	PZ																																																															
TB2820A0	6X10 EPDM PIPE FOR WASHING SYSTEM	2.400	M																																																															
TB3132A0	WHITE-BLUE EPDM TEXTILE BRAID HOSE 6X12	1.220	M																																																															
VL1019A0	VIBRATION PUMP	1	PZ																																																															

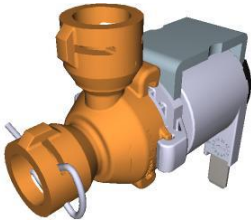
COMPONENT			SPARE PART																																																																						
Code	Description	Image	Code	Description	Components list																																																																				
EL1440A	WATER SELF CLEANING VALVE		KVL1184A	2 ROTOR ARMS PLUS EU CLEANING SYSTEM KIT	<table border="1"> <thead> <tr> <th>Code</th> <th>Description</th> <th>Qty</th> <th>UOM</th> </tr> </thead> <tbody> <tr> <td>VL1046A1</td> <td>D6 PIPE HOLDER - D6 J.G. TERMINAL</td> <td>3</td> <td>PZ</td> </tr> <tr> <td>VL1047A1</td> <td>D6 PIPE HOLDER - D8 J.G. TERMINAL</td> <td>1</td> <td>PZ</td> </tr> <tr> <td>VL1065A1</td> <td>1/4 MALE N.O. PRESSURE SWITCH</td> <td>1</td> <td>PZ</td> </tr> <tr> <td>VL1067A0</td> <td>WASHING SYSTEM INLETS DISTRIBUTOR</td> <td>1</td> <td>PZ</td> </tr> <tr> <td>VL1092A0</td> <td>WASHING SYSTEM OUTLET DOUBLE DISTRIBUTOR</td> <td>1</td> <td>PZ</td> </tr> <tr> <td>VL1102A1</td> <td>DETERGENT LINE FILTER + BARBED VNR 6 MM</td> <td>1</td> <td>PZ</td> </tr> <tr> <td>VL1128A0</td> <td>D6 BARBED CHECK VALVE</td> <td>2</td> <td>PZ</td> </tr> <tr> <td>VL1128A1</td> <td>D6 BARBED CHECK VALVE</td> <td>2</td> <td>PZ</td> </tr> <tr> <td>VL1141A1</td> <td>STRAIGHT CONNECT BB6-BB6</td> <td>1</td> <td>PZ</td> </tr> <tr> <td>VL1165A0</td> <td>BB6-AR6 STRAIGHT FITTING</td> <td>4</td> <td>PZ</td> </tr> <tr> <td>VL1166A0</td> <td>BB6-AR6 L FITTING</td> <td>4</td> <td>PZ</td> </tr> <tr> <td>VL1174C0</td> <td>D1.2 MM CALIBRATED NOZZLE</td> <td>1</td> <td>PZ</td> </tr> <tr> <td>VL1186A0</td> <td>3 WAYS PLUS WASHING DISTRIBUTOR</td> <td>1</td> <td>PZ</td> </tr> <tr> <td>VL1190A0</td> <td>PLUS WASHING SYSTEM INLET DISTRIBUTOR</td> <td>1</td> <td>PZ</td> </tr> <tr> <td>VM1605A0</td> <td>CLIP TWIST LOCK DIAM. 10,2-12,7 MM</td> <td>4</td> <td>PZ</td> </tr> <tr> <td>VM2172A0</td> <td>PUMP-WITH-CI RCUIT LOCKING PIN</td> <td>9</td> <td>PZ</td> </tr> </tbody> </table>	Code	Description	Qty	UOM	VL1046A1	D6 PIPE HOLDER - D6 J.G. TERMINAL	3	PZ	VL1047A1	D6 PIPE HOLDER - D8 J.G. TERMINAL	1	PZ	VL1065A1	1/4 MALE N.O. PRESSURE SWITCH	1	PZ	VL1067A0	WASHING SYSTEM INLETS DISTRIBUTOR	1	PZ	VL1092A0	WASHING SYSTEM OUTLET DOUBLE DISTRIBUTOR	1	PZ	VL1102A1	DETERGENT LINE FILTER + BARBED VNR 6 MM	1	PZ	VL1128A0	D6 BARBED CHECK VALVE	2	PZ	VL1128A1	D6 BARBED CHECK VALVE	2	PZ	VL1141A1	STRAIGHT CONNECT BB6-BB6	1	PZ	VL1165A0	BB6-AR6 STRAIGHT FITTING	4	PZ	VL1166A0	BB6-AR6 L FITTING	4	PZ	VL1174C0	D1.2 MM CALIBRATED NOZZLE	1	PZ	VL1186A0	3 WAYS PLUS WASHING DISTRIBUTOR	1	PZ	VL1190A0	PLUS WASHING SYSTEM INLET DISTRIBUTOR	1	PZ	VM1605A0	CLIP TWIST LOCK DIAM. 10,2-12,7 MM	4	PZ	VM2172A0	PUMP-WITH-CI RCUIT LOCKING PIN	9	PZ
Code	Description	Qty	UOM																																																																						
VL1046A1	D6 PIPE HOLDER - D6 J.G. TERMINAL	3	PZ																																																																						
VL1047A1	D6 PIPE HOLDER - D8 J.G. TERMINAL	1	PZ																																																																						
VL1065A1	1/4 MALE N.O. PRESSURE SWITCH	1	PZ																																																																						
VL1067A0	WASHING SYSTEM INLETS DISTRIBUTOR	1	PZ																																																																						
VL1092A0	WASHING SYSTEM OUTLET DOUBLE DISTRIBUTOR	1	PZ																																																																						
VL1102A1	DETERGENT LINE FILTER + BARBED VNR 6 MM	1	PZ																																																																						
VL1128A0	D6 BARBED CHECK VALVE	2	PZ																																																																						
VL1128A1	D6 BARBED CHECK VALVE	2	PZ																																																																						
VL1141A1	STRAIGHT CONNECT BB6-BB6	1	PZ																																																																						
VL1165A0	BB6-AR6 STRAIGHT FITTING	4	PZ																																																																						
VL1166A0	BB6-AR6 L FITTING	4	PZ																																																																						
VL1174C0	D1.2 MM CALIBRATED NOZZLE	1	PZ																																																																						
VL1186A0	3 WAYS PLUS WASHING DISTRIBUTOR	1	PZ																																																																						
VL1190A0	PLUS WASHING SYSTEM INLET DISTRIBUTOR	1	PZ																																																																						
VM1605A0	CLIP TWIST LOCK DIAM. 10,2-12,7 MM	4	PZ																																																																						
VM2172A0	PUMP-WITH-CI RCUIT LOCKING PIN	9	PZ																																																																						

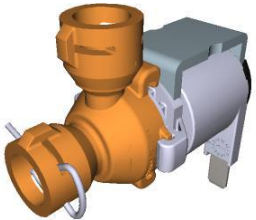
COMPONENT			SPARE PART																																																																																						
Code	Description	Image	Code	Description	Components list																																																																																				
EL1440A	WATER SELF CLEANING VALVE		KVL1183A	1 ROTOR ARM PLUS CLEANING SYSTEM KIT	<table border="1"> <thead> <tr> <th>Code</th> <th>Description</th> <th>Qty</th> <th>UOM</th> </tr> </thead> <tbody> <tr> <td>0H2143A0</td> <td>LAMIERA BLOCCA VNR VL1128</td> <td>2</td> <td>PZ</td> </tr> <tr> <td>0H2168A1</td> <td></td> <td>1</td> <td>PZ</td> </tr> <tr> <td>0H2354A0</td> <td>XEVC-XEVL WASHING CIRCUIT PLAT</td> <td>1</td> <td>PZ</td> </tr> <tr> <td>EL1440A0</td> <td>WATER SELF CLEANING VALVE</td> <td>3</td> <td>PZ</td> </tr> <tr> <td>GN1526A0</td> <td>INT. D.=6.9 TH=1.8 O-RIN</td> <td>7</td> <td>PZ</td> </tr> <tr> <td>RC1018A0</td> <td>ZINC PLATED D12 ELASTIC CLAMP</td> <td>2</td> <td>PZ</td> </tr> <tr> <td>RC1019A0</td> <td>D=10 ELASTIC CLAMP</td> <td>14</td> <td>PZ</td> </tr> <tr> <td>RC1130A0</td> <td>130X2,6 CLAM</td> <td>5</td> <td>PZ</td> </tr> <tr> <td>RC1131A0</td> <td>200X2.6 BLACK CLAMP</td> <td>2</td> <td>PZ</td> </tr> <tr> <td>RC1242A0</td> <td>D=10 CLOSED CAP</td> <td>2</td> <td>PZ</td> </tr> <tr> <td>RC1356A0</td> <td>"STRAIGHT THREADED FEMALE END 8X1/4" BS</td> <td>1</td> <td>PZ</td> </tr> <tr> <td>TB2820A0</td> <td>6X10 EPDM PIPE FOR WASHING SYSTEM</td> <td>1.410</td> <td>M</td> </tr> <tr> <td>TB3132A0</td> <td>WHITE-BLUE EPDM TEXTILE BRAID HOSE 6X12</td> <td>0.770</td> <td>M</td> </tr> <tr> <td>VH1220A1</td> <td>4,2X12 TCB SELF-TAPPIN G SCREW</td> <td>3</td> <td>PZ</td> </tr> <tr> <td>VL1019A0</td> <td>VIBRATION PUMP</td> <td>1</td> <td>PZ</td> </tr> <tr> <td>VL1047A1</td> <td>D6 PIPE HOLDER - D8 J.G. TERMINAL</td> <td>1</td> <td>PZ</td> </tr> <tr> <td>VL1065A1</td> <td>1/4 MALE N.O. PRESSURE SWITCH</td> <td>1</td> <td>PZ</td> </tr> <tr> <td>VL1102A1</td> <td>DETERGENT LINE FILTER + BARBED VNR 6 MM</td> <td>1</td> <td>PZ</td> </tr> <tr> <td>VL1128A0</td> <td>D6 BARBED CHECK VALVE</td> <td>2</td> <td>PZ</td> </tr> <tr> <td>VL1128A1</td> <td>D6 BARBED CHECK VALVE</td> <td>2</td> <td>PZ</td> </tr> </tbody> </table>	Code	Description	Qty	UOM	0H2143A0	LAMIERA BLOCCA VNR VL1128	2	PZ	0H2168A1		1	PZ	0H2354A0	XEVC-XEVL WASHING CIRCUIT PLAT	1	PZ	EL1440A0	WATER SELF CLEANING VALVE	3	PZ	GN1526A0	INT. D.=6.9 TH=1.8 O-RIN	7	PZ	RC1018A0	ZINC PLATED D12 ELASTIC CLAMP	2	PZ	RC1019A0	D=10 ELASTIC CLAMP	14	PZ	RC1130A0	130X2,6 CLAM	5	PZ	RC1131A0	200X2.6 BLACK CLAMP	2	PZ	RC1242A0	D=10 CLOSED CAP	2	PZ	RC1356A0	"STRAIGHT THREADED FEMALE END 8X1/4" BS	1	PZ	TB2820A0	6X10 EPDM PIPE FOR WASHING SYSTEM	1.410	M	TB3132A0	WHITE-BLUE EPDM TEXTILE BRAID HOSE 6X12	0.770	M	VH1220A1	4,2X12 TCB SELF-TAPPIN G SCREW	3	PZ	VL1019A0	VIBRATION PUMP	1	PZ	VL1047A1	D6 PIPE HOLDER - D8 J.G. TERMINAL	1	PZ	VL1065A1	1/4 MALE N.O. PRESSURE SWITCH	1	PZ	VL1102A1	DETERGENT LINE FILTER + BARBED VNR 6 MM	1	PZ	VL1128A0	D6 BARBED CHECK VALVE	2	PZ	VL1128A1	D6 BARBED CHECK VALVE	2	PZ
Code	Description	Qty	UOM																																																																																						
0H2143A0	LAMIERA BLOCCA VNR VL1128	2	PZ																																																																																						
0H2168A1		1	PZ																																																																																						
0H2354A0	XEVC-XEVL WASHING CIRCUIT PLAT	1	PZ																																																																																						
EL1440A0	WATER SELF CLEANING VALVE	3	PZ																																																																																						
GN1526A0	INT. D.=6.9 TH=1.8 O-RIN	7	PZ																																																																																						
RC1018A0	ZINC PLATED D12 ELASTIC CLAMP	2	PZ																																																																																						
RC1019A0	D=10 ELASTIC CLAMP	14	PZ																																																																																						
RC1130A0	130X2,6 CLAM	5	PZ																																																																																						
RC1131A0	200X2.6 BLACK CLAMP	2	PZ																																																																																						
RC1242A0	D=10 CLOSED CAP	2	PZ																																																																																						
RC1356A0	"STRAIGHT THREADED FEMALE END 8X1/4" BS	1	PZ																																																																																						
TB2820A0	6X10 EPDM PIPE FOR WASHING SYSTEM	1.410	M																																																																																						
TB3132A0	WHITE-BLUE EPDM TEXTILE BRAID HOSE 6X12	0.770	M																																																																																						
VH1220A1	4,2X12 TCB SELF-TAPPIN G SCREW	3	PZ																																																																																						
VL1019A0	VIBRATION PUMP	1	PZ																																																																																						
VL1047A1	D6 PIPE HOLDER - D8 J.G. TERMINAL	1	PZ																																																																																						
VL1065A1	1/4 MALE N.O. PRESSURE SWITCH	1	PZ																																																																																						
VL1102A1	DETERGENT LINE FILTER + BARBED VNR 6 MM	1	PZ																																																																																						
VL1128A0	D6 BARBED CHECK VALVE	2	PZ																																																																																						
VL1128A1	D6 BARBED CHECK VALVE	2	PZ																																																																																						

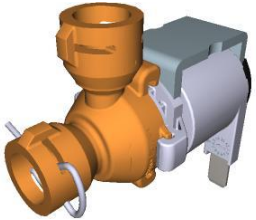
COMPONENT			SPARE PART																																															
Code	Description	Image	Code	Description	Components list																																													
EL1440A	WATER SELF CLEANING VALVE		KVL1183A	1 ROTOR ARM PLUS CLEANING SYSTEM KIT	<table border="1"> <thead> <tr> <th>Code</th> <th>Description</th> <th>Qty</th> <th>UOM</th> </tr> </thead> <tbody> <tr> <td>VL1165A0</td> <td>BB6-AR6 STRAIGHT FITTING</td> <td>1</td> <td>PZ</td> </tr> <tr> <td>VL1166A0</td> <td>BB6-AR6 L FITTING</td> <td>3</td> <td>PZ</td> </tr> <tr> <td>VL1174C0</td> <td>D1.2 MM CALIBRATED NOZZLE</td> <td>1</td> <td>PZ</td> </tr> <tr> <td>VL1185A0</td> <td>2 WAYS PLUS WASHING DISTRIBUTOR</td> <td>1</td> <td>PZ</td> </tr> <tr> <td>VL1190A0</td> <td>PLUS WASHING SYSTEM INLET DISTRIBUTOR</td> <td>1</td> <td>PZ</td> </tr> <tr> <td>VM1605A0</td> <td>CLIP TWIST LOCK DIAM. 10,2-12,7 MM</td> <td>3</td> <td>PZ</td> </tr> <tr> <td>VM2172A0</td> <td>PUMP-WITH-CI RCUIT LOCKING PIN</td> <td>7</td> <td>PZ</td> </tr> </tbody> </table>	Code	Description	Qty	UOM	VL1165A0	BB6-AR6 STRAIGHT FITTING	1	PZ	VL1166A0	BB6-AR6 L FITTING	3	PZ	VL1174C0	D1.2 MM CALIBRATED NOZZLE	1	PZ	VL1185A0	2 WAYS PLUS WASHING DISTRIBUTOR	1	PZ	VL1190A0	PLUS WASHING SYSTEM INLET DISTRIBUTOR	1	PZ	VM1605A0	CLIP TWIST LOCK DIAM. 10,2-12,7 MM	3	PZ	VM2172A0	PUMP-WITH-CI RCUIT LOCKING PIN	7	PZ													
			Code	Description	Qty	UOM																																												
VL1165A0	BB6-AR6 STRAIGHT FITTING	1	PZ																																															
VL1166A0	BB6-AR6 L FITTING	3	PZ																																															
VL1174C0	D1.2 MM CALIBRATED NOZZLE	1	PZ																																															
VL1185A0	2 WAYS PLUS WASHING DISTRIBUTOR	1	PZ																																															
VL1190A0	PLUS WASHING SYSTEM INLET DISTRIBUTOR	1	PZ																																															
VM1605A0	CLIP TWIST LOCK DIAM. 10,2-12,7 MM	3	PZ																																															
VM2172A0	PUMP-WITH-CI RCUIT LOCKING PIN	7	PZ																																															
KVL1182A	ONE CLEANING SYSTEM KIT (0311 EXC.)	<table border="1"> <thead> <tr> <th>Code</th> <th>Description</th> <th>Qty</th> <th>UOM</th> </tr> </thead> <tbody> <tr> <td>0H2143A0</td> <td>LAMIERA BLOCCA VNR VL1128</td> <td>2</td> <td>PZ</td> </tr> <tr> <td>0H2202A1</td> <td>ONE WASHING WITH STEAM VALVE SUPPORT</td> <td>1</td> <td>PZ</td> </tr> <tr> <td>EL1440A0</td> <td>WATER SELF CLEANING VALVE</td> <td>1</td> <td>PZ</td> </tr> <tr> <td>GN1526A0</td> <td>INT. D.=6.9 TH=1.8 O-RIN</td> <td>3</td> <td>PZ</td> </tr> <tr> <td>RC1018A0</td> <td>ZINC PLATED D12 ELASTIC CLAMP</td> <td>1</td> <td>PZ</td> </tr> <tr> <td>RC1019A0</td> <td>D=10 ELASTIC CLAMP</td> <td>14</td> <td>PZ</td> </tr> <tr> <td>RC1130A0</td> <td>130X2,6 CLAM</td> <td>2</td> <td>PZ</td> </tr> <tr> <td>RC1242A0</td> <td>D=10 CLOSED CAP</td> <td>2</td> <td>PZ</td> </tr> <tr> <td>TB2820A0</td> <td>6X10 EPDM PIPE FOR WASHING SYSTEM</td> <td>1.410</td> <td>M</td> </tr> <tr> <td>TB3132A0</td> <td>WHITE-BLUE EPDM TEXTILE BRAID HOSE 6X12</td> <td>0.670</td> <td>M</td> </tr> <tr> <td>VH1220A1</td> <td>4,2X12 TCB SELF-TAPPIN G SCREW</td> <td>1</td> <td>PZ</td> </tr> </tbody> </table>	Code	Description	Qty	UOM	0H2143A0	LAMIERA BLOCCA VNR VL1128	2	PZ	0H2202A1	ONE WASHING WITH STEAM VALVE SUPPORT	1	PZ	EL1440A0	WATER SELF CLEANING VALVE	1	PZ	GN1526A0	INT. D.=6.9 TH=1.8 O-RIN	3	PZ	RC1018A0	ZINC PLATED D12 ELASTIC CLAMP	1	PZ	RC1019A0	D=10 ELASTIC CLAMP	14	PZ	RC1130A0	130X2,6 CLAM	2	PZ	RC1242A0	D=10 CLOSED CAP	2	PZ	TB2820A0	6X10 EPDM PIPE FOR WASHING SYSTEM	1.410	M	TB3132A0	WHITE-BLUE EPDM TEXTILE BRAID HOSE 6X12	0.670	M	VH1220A1	4,2X12 TCB SELF-TAPPIN G SCREW	1	PZ
Code	Description	Qty	UOM																																															
0H2143A0	LAMIERA BLOCCA VNR VL1128	2	PZ																																															
0H2202A1	ONE WASHING WITH STEAM VALVE SUPPORT	1	PZ																																															
EL1440A0	WATER SELF CLEANING VALVE	1	PZ																																															
GN1526A0	INT. D.=6.9 TH=1.8 O-RIN	3	PZ																																															
RC1018A0	ZINC PLATED D12 ELASTIC CLAMP	1	PZ																																															
RC1019A0	D=10 ELASTIC CLAMP	14	PZ																																															
RC1130A0	130X2,6 CLAM	2	PZ																																															
RC1242A0	D=10 CLOSED CAP	2	PZ																																															
TB2820A0	6X10 EPDM PIPE FOR WASHING SYSTEM	1.410	M																																															
TB3132A0	WHITE-BLUE EPDM TEXTILE BRAID HOSE 6X12	0.670	M																																															
VH1220A1	4,2X12 TCB SELF-TAPPIN G SCREW	1	PZ																																															

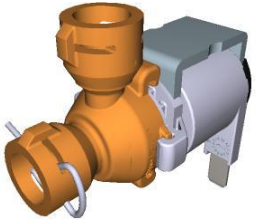
COMPONENT			SPARE PART																																																																													
Code	Description	Image	Code	Description	Components list																																																																											
EL1440A	WATER SELF CLEANING VALVE		KVL1182A	ONE CLEANING SYSTEM KIT (0311 EXC.)	<table border="1"> <thead> <tr> <th>Code</th> <th>Description</th> <th>Qty</th> <th>UOM</th> </tr> </thead> <tbody> <tr> <td>VL1019A0</td> <td>VIBRATION PUMP</td> <td>1</td> <td>PZ</td> </tr> <tr> <td>VL1047A1</td> <td>D6 PIPE HOLDER - D8 J.G. TERMINAL</td> <td>1</td> <td>PZ</td> </tr> <tr> <td>VL1054B0</td> <td>ONE WASHING SYS INLET DISTRIBUTOR</td> <td>1</td> <td>PZ</td> </tr> <tr> <td>VL1102A1</td> <td>DETERGENT LINE FILTER + BARBED VNR 6 MM</td> <td>1</td> <td>PZ</td> </tr> <tr> <td>VL1128A0</td> <td>D6 BARBED CHECK VALVE</td> <td>2</td> <td>PZ</td> </tr> <tr> <td>VL1128A1</td> <td>D6 BARBED CHECK VALVE</td> <td>2</td> <td>PZ</td> </tr> <tr> <td>VL1165A0</td> <td>BB6-AR6 STRAIGHT FITTING</td> <td>1</td> <td>PZ</td> </tr> <tr> <td>VL1166A0</td> <td>BB6-AR6 L FITTING</td> <td>1</td> <td>PZ</td> </tr> <tr> <td>VL1174C0</td> <td>D1.2 MM CALIBRATED NOZZLE</td> <td>1</td> <td>PZ</td> </tr> <tr> <td>VL1191A0</td> <td>ONE WASHING DISTRIBUTOR OUTLETS KIT</td> <td>1</td> <td>PZ</td> </tr> <tr> <td>VM1605A0</td> <td>CLIP TWIST LOCK DIAM. 10,2-12,7 MM</td> <td>3</td> <td>PZ</td> </tr> <tr> <td>VM2172A0</td> <td>PUMP-WITH-CI RCUIT LOCKING PIN</td> <td>2</td> <td>PZ</td> </tr> </tbody> </table>	Code	Description	Qty	UOM	VL1019A0	VIBRATION PUMP	1	PZ	VL1047A1	D6 PIPE HOLDER - D8 J.G. TERMINAL	1	PZ	VL1054B0	ONE WASHING SYS INLET DISTRIBUTOR	1	PZ	VL1102A1	DETERGENT LINE FILTER + BARBED VNR 6 MM	1	PZ	VL1128A0	D6 BARBED CHECK VALVE	2	PZ	VL1128A1	D6 BARBED CHECK VALVE	2	PZ	VL1165A0	BB6-AR6 STRAIGHT FITTING	1	PZ	VL1166A0	BB6-AR6 L FITTING	1	PZ	VL1174C0	D1.2 MM CALIBRATED NOZZLE	1	PZ	VL1191A0	ONE WASHING DISTRIBUTOR OUTLETS KIT	1	PZ	VM1605A0	CLIP TWIST LOCK DIAM. 10,2-12,7 MM	3	PZ	VM2172A0	PUMP-WITH-CI RCUIT LOCKING PIN	2	PZ	KEL1440A	SELF CLEANING WATER VALVE KIT	<table border="1"> <thead> <tr> <th>Code</th> <th>Description</th> <th>Qty</th> <th>UOM</th> </tr> </thead> <tbody> <tr> <td>EL1440A0</td> <td>WATER SELF CLEANING VALVE</td> <td>1</td> <td>PZ</td> </tr> <tr> <td>GN1526A0</td> <td>INT. D.=6.9 TH=1.8 O-RIN</td> <td>2</td> <td>PZ</td> </tr> <tr> <td>RC1131A0</td> <td>200X2.6 BLACK CLAMP</td> <td>1</td> <td>PZ</td> </tr> <tr> <td>VM1224A0</td> <td>65MY 220MM 2 COLOURS SHRINK TUBE</td> <td>0.250</td> <td>M</td> </tr> </tbody> </table>	Code	Description	Qty	UOM	EL1440A0	WATER SELF CLEANING VALVE	1	PZ	GN1526A0	INT. D.=6.9 TH=1.8 O-RIN	2	PZ	RC1131A0	200X2.6 BLACK CLAMP	1	PZ	VM1224A0	65MY 220MM 2 COLOURS SHRINK TUBE	0.250	M
			Code	Description	Qty	UOM																																																																										
VL1019A0	VIBRATION PUMP	1	PZ																																																																													
VL1047A1	D6 PIPE HOLDER - D8 J.G. TERMINAL	1	PZ																																																																													
VL1054B0	ONE WASHING SYS INLET DISTRIBUTOR	1	PZ																																																																													
VL1102A1	DETERGENT LINE FILTER + BARBED VNR 6 MM	1	PZ																																																																													
VL1128A0	D6 BARBED CHECK VALVE	2	PZ																																																																													
VL1128A1	D6 BARBED CHECK VALVE	2	PZ																																																																													
VL1165A0	BB6-AR6 STRAIGHT FITTING	1	PZ																																																																													
VL1166A0	BB6-AR6 L FITTING	1	PZ																																																																													
VL1174C0	D1.2 MM CALIBRATED NOZZLE	1	PZ																																																																													
VL1191A0	ONE WASHING DISTRIBUTOR OUTLETS KIT	1	PZ																																																																													
VM1605A0	CLIP TWIST LOCK DIAM. 10,2-12,7 MM	3	PZ																																																																													
VM2172A0	PUMP-WITH-CI RCUIT LOCKING PIN	2	PZ																																																																													
Code	Description	Qty	UOM																																																																													
EL1440A0	WATER SELF CLEANING VALVE	1	PZ																																																																													
GN1526A0	INT. D.=6.9 TH=1.8 O-RIN	2	PZ																																																																													
RC1131A0	200X2.6 BLACK CLAMP	1	PZ																																																																													
VM1224A0	65MY 220MM 2 COLOURS SHRINK TUBE	0.250	M																																																																													





COMPONENT			SPARE PART																																																																														
Code	Description	Image	Code	Description	Components list																																																																												
VL1166A	BB6-AR6 L FITTING		KVL2618A	2 ROTOR ARMS ONE CLEANING SYSTEM KIT	<table border="1"> <thead> <tr> <th>Code</th> <th>Description</th> <th>Qty</th> <th>UOM</th> </tr> </thead> <tbody> <tr> <td>0H2202A1</td> <td>ONE WASHING WITH STEAM VALVE SUPPORT</td> <td>2</td> <td>PZ</td> </tr> <tr> <td>CE1030A0</td> <td>FEMALE FASTON COVER 6.3X0.8 0,5-1MMQ</td> <td>4</td> <td>PZ</td> </tr> <tr> <td>CE1395A0</td> <td>6,3 X 0,8 IMALE FASTO</td> <td>2</td> <td>PZ</td> </tr> <tr> <td>CE1545A0</td> <td>BLUE UNIP AWG18 ST.3135 WIRE</td> <td>1</td> <td>M</td> </tr> <tr> <td>CE1570A0</td> <td>WHITE UNIP AWG18 ST.3135 WIRE</td> <td>1</td> <td>M</td> </tr> <tr> <td>CE1660A0</td> <td>6,3X0,8 FEMALE FASTON COVE</td> <td>4</td> <td>PZ</td> </tr> <tr> <td>CE1661A0</td> <td>MALE FASTON COVER 6,3X0,</td> <td>2</td> <td>PZ</td> </tr> <tr> <td>EL1020A1</td> <td>D8 INTERMEDIAT E T-SHAPED FITTING</td> <td>1</td> <td>PZ</td> </tr> <tr> <td>EL1440A0</td> <td>WATER SELF CLEANING VALVE</td> <td>2</td> <td>PZ</td> </tr> <tr> <td>GN1526A0</td> <td>INT. D.=6.9 TH=1.8 O-RIN</td> <td>6</td> <td>PZ</td> </tr> <tr> <td>IP1385A1</td> <td>CORNER POLYSTYREN E PACKING 110X80X2000</td> <td>0.500</td> <td>M</td> </tr> <tr> <td>RC1018A0</td> <td>ZINC PLATED D12 ELASTIC CLAMP</td> <td>4</td> <td>PZ</td> </tr> <tr> <td>RC1019A0</td> <td>D=10 ELASTIC CLAMP</td> <td>31</td> <td>PZ</td> </tr> <tr> <td>RC1130A0</td> <td>130X2,6 CLAM</td> <td>4</td> <td>PZ</td> </tr> <tr> <td>RC1242A0</td> <td>D=10 CLOSED CAP</td> <td>4</td> <td>PZ</td> </tr> <tr> <td>TB2820A0</td> <td>6X10 EPDM PIPE FOR WASHING SYSTEM</td> <td>2.920</td> <td>M</td> </tr> <tr> <td>TB3132A0</td> <td>WHITE-BLUE EPDM TEXTILE BRAID HOSE 6X12</td> <td>1.340</td> <td>M</td> </tr> <tr> <td>VI1220A1</td> <td>4,2X12 TCB SELF-TAPPIN G SCREW</td> <td>2</td> <td>PZ</td> </tr> </tbody> </table>	Code	Description	Qty	UOM	0H2202A1	ONE WASHING WITH STEAM VALVE SUPPORT	2	PZ	CE1030A0	FEMALE FASTON COVER 6.3X0.8 0,5-1MMQ	4	PZ	CE1395A0	6,3 X 0,8 IMALE FASTO	2	PZ	CE1545A0	BLUE UNIP AWG18 ST.3135 WIRE	1	M	CE1570A0	WHITE UNIP AWG18 ST.3135 WIRE	1	M	CE1660A0	6,3X0,8 FEMALE FASTON COVE	4	PZ	CE1661A0	MALE FASTON COVER 6,3X0,	2	PZ	EL1020A1	D8 INTERMEDIAT E T-SHAPED FITTING	1	PZ	EL1440A0	WATER SELF CLEANING VALVE	2	PZ	GN1526A0	INT. D.=6.9 TH=1.8 O-RIN	6	PZ	IP1385A1	CORNER POLYSTYREN E PACKING 110X80X2000	0.500	M	RC1018A0	ZINC PLATED D12 ELASTIC CLAMP	4	PZ	RC1019A0	D=10 ELASTIC CLAMP	31	PZ	RC1130A0	130X2,6 CLAM	4	PZ	RC1242A0	D=10 CLOSED CAP	4	PZ	TB2820A0	6X10 EPDM PIPE FOR WASHING SYSTEM	2.920	M	TB3132A0	WHITE-BLUE EPDM TEXTILE BRAID HOSE 6X12	1.340	M	VI1220A1	4,2X12 TCB SELF-TAPPIN G SCREW	2	PZ
Code	Description	Qty	UOM																																																																														
0H2202A1	ONE WASHING WITH STEAM VALVE SUPPORT	2	PZ																																																																														
CE1030A0	FEMALE FASTON COVER 6.3X0.8 0,5-1MMQ	4	PZ																																																																														
CE1395A0	6,3 X 0,8 IMALE FASTO	2	PZ																																																																														
CE1545A0	BLUE UNIP AWG18 ST.3135 WIRE	1	M																																																																														
CE1570A0	WHITE UNIP AWG18 ST.3135 WIRE	1	M																																																																														
CE1660A0	6,3X0,8 FEMALE FASTON COVE	4	PZ																																																																														
CE1661A0	MALE FASTON COVER 6,3X0,	2	PZ																																																																														
EL1020A1	D8 INTERMEDIAT E T-SHAPED FITTING	1	PZ																																																																														
EL1440A0	WATER SELF CLEANING VALVE	2	PZ																																																																														
GN1526A0	INT. D.=6.9 TH=1.8 O-RIN	6	PZ																																																																														
IP1385A1	CORNER POLYSTYREN E PACKING 110X80X2000	0.500	M																																																																														
RC1018A0	ZINC PLATED D12 ELASTIC CLAMP	4	PZ																																																																														
RC1019A0	D=10 ELASTIC CLAMP	31	PZ																																																																														
RC1130A0	130X2,6 CLAM	4	PZ																																																																														
RC1242A0	D=10 CLOSED CAP	4	PZ																																																																														
TB2820A0	6X10 EPDM PIPE FOR WASHING SYSTEM	2.920	M																																																																														
TB3132A0	WHITE-BLUE EPDM TEXTILE BRAID HOSE 6X12	1.340	M																																																																														
VI1220A1	4,2X12 TCB SELF-TAPPIN G SCREW	2	PZ																																																																														



COMPONENT			SPARE PART																																																		
Code	Description	Image	Code	Description	Components list																																																
VL1166A	BB6-AR6 L FITTING		KVL2618A	2 ROTOR ARMS ONE CLEANING SYSTEM KIT	<table border="1"> <thead> <tr> <th>Code</th> <th>Description</th> <th>Qty</th> <th>UOM</th> </tr> </thead> <tbody> <tr> <td>VL1019A0</td> <td>VIBRATION PUMP</td> <td>2</td> <td>PZ</td> </tr> <tr> <td>VL1047A1</td> <td>D6 PIPE HOLDER - D8 J.G. TERMINAL</td> <td>2</td> <td>PZ</td> </tr> <tr> <td>VL1054B0</td> <td>ONE WASHING SYS INLET DISTRIBUTOR</td> <td>2</td> <td>PZ</td> </tr> <tr> <td>VL1102A1</td> <td>DETERGENT LINE FILTER + BARBED VNR 6 MM</td> <td>2</td> <td>PZ</td> </tr> <tr> <td>VL1127A1</td> <td>6MM BARBED T-SHAPED FITTING</td> <td>1</td> <td>PZ</td> </tr> <tr> <td>VL1128A1</td> <td>D6 BARBED CHECK VALVE</td> <td>4</td> <td>PZ</td> </tr> <tr> <td>VL1165A0</td> <td>BB6-AR6 STRAIGHT FITTING</td> <td>2</td> <td>PZ</td> </tr> <tr> <td>VL1166A0</td> <td>BB6-AR6 L FITTING</td> <td>2</td> <td>PZ</td> </tr> <tr> <td>VL1174C0</td> <td>D1.2 MM CALIBRATED NOZZLE</td> <td>2</td> <td>PZ</td> </tr> <tr> <td>VL1191A0</td> <td>ONE WASHING DISTRIBUTOR OUTLETS KIT</td> <td>2</td> <td>PZ</td> </tr> <tr> <td>VM2172A0</td> <td>PUMP-WITH-CI RCUIT LOCKING PIN</td> <td>4</td> <td>PZ</td> </tr> </tbody> </table>	Code	Description	Qty	UOM	VL1019A0	VIBRATION PUMP	2	PZ	VL1047A1	D6 PIPE HOLDER - D8 J.G. TERMINAL	2	PZ	VL1054B0	ONE WASHING SYS INLET DISTRIBUTOR	2	PZ	VL1102A1	DETERGENT LINE FILTER + BARBED VNR 6 MM	2	PZ	VL1127A1	6MM BARBED T-SHAPED FITTING	1	PZ	VL1128A1	D6 BARBED CHECK VALVE	4	PZ	VL1165A0	BB6-AR6 STRAIGHT FITTING	2	PZ	VL1166A0	BB6-AR6 L FITTING	2	PZ	VL1174C0	D1.2 MM CALIBRATED NOZZLE	2	PZ	VL1191A0	ONE WASHING DISTRIBUTOR OUTLETS KIT	2	PZ	VM2172A0	PUMP-WITH-CI RCUIT LOCKING PIN	4	PZ
Code	Description	Qty	UOM																																																		
VL1019A0	VIBRATION PUMP	2	PZ																																																		
VL1047A1	D6 PIPE HOLDER - D8 J.G. TERMINAL	2	PZ																																																		
VL1054B0	ONE WASHING SYS INLET DISTRIBUTOR	2	PZ																																																		
VL1102A1	DETERGENT LINE FILTER + BARBED VNR 6 MM	2	PZ																																																		
VL1127A1	6MM BARBED T-SHAPED FITTING	1	PZ																																																		
VL1128A1	D6 BARBED CHECK VALVE	4	PZ																																																		
VL1165A0	BB6-AR6 STRAIGHT FITTING	2	PZ																																																		
VL1166A0	BB6-AR6 L FITTING	2	PZ																																																		
VL1174C0	D1.2 MM CALIBRATED NOZZLE	2	PZ																																																		
VL1191A0	ONE WASHING DISTRIBUTOR OUTLETS KIT	2	PZ																																																		
VM2172A0	PUMP-WITH-CI RCUIT LOCKING PIN	4	PZ																																																		
			KVL1225A	US HOOD WASHING SYSTEM KIT	<table border="1"> <thead> <tr> <th>Code</th> <th>Description</th> <th>Qty</th> <th>UOM</th> </tr> </thead> <tbody> <tr> <td>0H2213A1</td> <td>HOOD WATER CIRCUIT PLAT</td> <td>1</td> <td>PZ</td> </tr> <tr> <td>EL1450A0</td> <td>US SELF-CLEANIN G WATER SOLENOID</td> <td>2</td> <td>PZ</td> </tr> <tr> <td>GN1526A0</td> <td>INT. D.=6.9 TH=1.8 O-RIN</td> <td>5</td> <td>PZ</td> </tr> <tr> <td>RC1018A0</td> <td>ZINC PLATED D12 ELASTIC CLAMP</td> <td>5</td> <td>PZ</td> </tr> <tr> <td>RC1019A0</td> <td>D=10 ELASTIC CLAMP</td> <td>16</td> <td>PZ</td> </tr> <tr> <td>RC1131A0</td> <td>200X2.6 BLACK CLAMP</td> <td>1</td> <td>PZ</td> </tr> <tr> <td>RC1242A0</td> <td>D=10 CLOSED CAP</td> <td>2</td> <td>PZ</td> </tr> </tbody> </table>	Code	Description	Qty	UOM	0H2213A1	HOOD WATER CIRCUIT PLAT	1	PZ	EL1450A0	US SELF-CLEANIN G WATER SOLENOID	2	PZ	GN1526A0	INT. D.=6.9 TH=1.8 O-RIN	5	PZ	RC1018A0	ZINC PLATED D12 ELASTIC CLAMP	5	PZ	RC1019A0	D=10 ELASTIC CLAMP	16	PZ	RC1131A0	200X2.6 BLACK CLAMP	1	PZ	RC1242A0	D=10 CLOSED CAP	2	PZ																
Code	Description	Qty	UOM																																																		
0H2213A1	HOOD WATER CIRCUIT PLAT	1	PZ																																																		
EL1450A0	US SELF-CLEANIN G WATER SOLENOID	2	PZ																																																		
GN1526A0	INT. D.=6.9 TH=1.8 O-RIN	5	PZ																																																		
RC1018A0	ZINC PLATED D12 ELASTIC CLAMP	5	PZ																																																		
RC1019A0	D=10 ELASTIC CLAMP	16	PZ																																																		
RC1131A0	200X2.6 BLACK CLAMP	1	PZ																																																		
RC1242A0	D=10 CLOSED CAP	2	PZ																																																		

COMPONENT			SPARE PART																																																																		
Code	Description	Image	Code	Description	Components list																																																																
VL1166A	BB6-AR6 L FITTING		KVL1225A	US HOOD WASHING SYSTEM KIT	<table border="1"> <thead> <tr> <th>Code</th> <th>Description</th> <th>Qty</th> <th>UOM</th> </tr> </thead> <tbody> <tr> <td>TB2820A0</td> <td>6X10 EPDM PIPE FOR WASHING SYSTEM</td> <td>2.240</td> <td>M</td> </tr> <tr> <td>TB3132A0</td> <td>WHITE-BLUE EPDM TEXTILE BRAID HOSE 6X12</td> <td>0.440</td> <td>M</td> </tr> <tr> <td>VI1220A1</td> <td>4,2X12 TCB SELF-TAPPIN G SCREW</td> <td>3</td> <td>PZ</td> </tr> <tr> <td>VL1019A0</td> <td>VIBRATION PUMP</td> <td>1</td> <td>PZ</td> </tr> <tr> <td>VL1047A1</td> <td>D6 PIPE HOLDER - D8 J.G. TERMINAL</td> <td>1</td> <td>PZ</td> </tr> <tr> <td>VL1054B0</td> <td>ONE WASHING SYS INLET DISTRIBUTOR</td> <td>1</td> <td>PZ</td> </tr> <tr> <td>VL1102A1</td> <td>DETERGENT LINE FILTER + BARBED VNR 6 MM</td> <td>1</td> <td>PZ</td> </tr> <tr> <td>VL1127A1</td> <td>6MM BARBED T-SHAPED FITTING</td> <td>1</td> <td>PZ</td> </tr> <tr> <td>VL1128A1</td> <td>D6 BARBED CHECK VALVE</td> <td>2</td> <td>PZ</td> </tr> <tr> <td>VL1165A0</td> <td>BB6-AR6 STRAIGHT FITTING</td> <td>2</td> <td>PZ</td> </tr> <tr> <td>VL1166A0</td> <td>BB6-AR6 L FITTING</td> <td>2</td> <td>PZ</td> </tr> <tr> <td>VL1174C0</td> <td>D1.2 MM CALIBRATED NOZZLE</td> <td>1</td> <td>PZ</td> </tr> <tr> <td>VL1191A0</td> <td>ONE WASHING DISTRIBUTOR OUTLETS KIT</td> <td>1</td> <td>PZ</td> </tr> <tr> <td>VM1605A0</td> <td>CLIP TWIST LOCK DIAM. 10,2-12,7 MM</td> <td>2</td> <td>PZ</td> </tr> <tr> <td>VM2172A0</td> <td>PUMP-WITH-CI RCUIT LOCKING PIN</td> <td>5</td> <td>PZ</td> </tr> </tbody> </table>	Code	Description	Qty	UOM	TB2820A0	6X10 EPDM PIPE FOR WASHING SYSTEM	2.240	M	TB3132A0	WHITE-BLUE EPDM TEXTILE BRAID HOSE 6X12	0.440	M	VI1220A1	4,2X12 TCB SELF-TAPPIN G SCREW	3	PZ	VL1019A0	VIBRATION PUMP	1	PZ	VL1047A1	D6 PIPE HOLDER - D8 J.G. TERMINAL	1	PZ	VL1054B0	ONE WASHING SYS INLET DISTRIBUTOR	1	PZ	VL1102A1	DETERGENT LINE FILTER + BARBED VNR 6 MM	1	PZ	VL1127A1	6MM BARBED T-SHAPED FITTING	1	PZ	VL1128A1	D6 BARBED CHECK VALVE	2	PZ	VL1165A0	BB6-AR6 STRAIGHT FITTING	2	PZ	VL1166A0	BB6-AR6 L FITTING	2	PZ	VL1174C0	D1.2 MM CALIBRATED NOZZLE	1	PZ	VL1191A0	ONE WASHING DISTRIBUTOR OUTLETS KIT	1	PZ	VM1605A0	CLIP TWIST LOCK DIAM. 10,2-12,7 MM	2	PZ	VM2172A0	PUMP-WITH-CI RCUIT LOCKING PIN	5	PZ
Code	Description	Qty	UOM																																																																		
TB2820A0	6X10 EPDM PIPE FOR WASHING SYSTEM	2.240	M																																																																		
TB3132A0	WHITE-BLUE EPDM TEXTILE BRAID HOSE 6X12	0.440	M																																																																		
VI1220A1	4,2X12 TCB SELF-TAPPIN G SCREW	3	PZ																																																																		
VL1019A0	VIBRATION PUMP	1	PZ																																																																		
VL1047A1	D6 PIPE HOLDER - D8 J.G. TERMINAL	1	PZ																																																																		
VL1054B0	ONE WASHING SYS INLET DISTRIBUTOR	1	PZ																																																																		
VL1102A1	DETERGENT LINE FILTER + BARBED VNR 6 MM	1	PZ																																																																		
VL1127A1	6MM BARBED T-SHAPED FITTING	1	PZ																																																																		
VL1128A1	D6 BARBED CHECK VALVE	2	PZ																																																																		
VL1165A0	BB6-AR6 STRAIGHT FITTING	2	PZ																																																																		
VL1166A0	BB6-AR6 L FITTING	2	PZ																																																																		
VL1174C0	D1.2 MM CALIBRATED NOZZLE	1	PZ																																																																		
VL1191A0	ONE WASHING DISTRIBUTOR OUTLETS KIT	1	PZ																																																																		
VM1605A0	CLIP TWIST LOCK DIAM. 10,2-12,7 MM	2	PZ																																																																		
VM2172A0	PUMP-WITH-CI RCUIT LOCKING PIN	5	PZ																																																																		
			KVL1222A	EUR 0311 ONE PLUS CLEANING SYSTEM KIT	<table border="1"> <thead> <tr> <th>Code</th> <th>Description</th> <th>Qty</th> <th>UOM</th> </tr> </thead> <tbody> <tr> <td>0H2486A0</td> <td>0311 WASHING CIRCUIT PLAT</td> <td>1</td> <td>PZ</td> </tr> <tr> <td>EL1440A0</td> <td>WATER SELF CLEANING VALVE</td> <td>1</td> <td>PZ</td> </tr> </tbody> </table>	Code	Description	Qty	UOM	0H2486A0	0311 WASHING CIRCUIT PLAT	1	PZ	EL1440A0	WATER SELF CLEANING VALVE	1	PZ																																																				
Code	Description	Qty	UOM																																																																		
0H2486A0	0311 WASHING CIRCUIT PLAT	1	PZ																																																																		
EL1440A0	WATER SELF CLEANING VALVE	1	PZ																																																																		

COMPONENT			SPARE PART																																																																										
Code	Description	Image	Code	Description	Components list																																																																								
VL1166A	BB6-AR6 L FITTING		KVL1222A	EUR 0311 ONE PLUS CLEANING SYSTEM KIT	<table border="1"> <thead> <tr> <th>Code</th> <th>Description</th> <th>Qty</th> <th>UOM</th> </tr> </thead> <tbody> <tr> <td>GN1526A0</td> <td>INT. D.=6.9 TH=1.8 O-RIN</td> <td>3</td> <td>PZ</td> </tr> <tr> <td>RC1018A0</td> <td>ZINC PLATED D12 ELASTIC CLAMP</td> <td>2</td> <td>PZ</td> </tr> <tr> <td>RC1019A0</td> <td>D=10 ELASTIC CLAMP</td> <td>14</td> <td>PZ</td> </tr> <tr> <td>RC1242A0</td> <td>D=10 CLOSED CAP</td> <td>2</td> <td>PZ</td> </tr> <tr> <td>TB2820A0</td> <td>6X10 EPDM PIPE FOR WASHING SYSTEM</td> <td>1.460</td> <td>M</td> </tr> <tr> <td>TB3132A0</td> <td>WHITE-BLUE EPDM TEXTILE BRAID HOSE 6X12</td> <td>0.670</td> <td>M</td> </tr> <tr> <td>VI1220A1</td> <td>4,2X12 TCB SELF-TAPPIN G SCREW</td> <td>4</td> <td>PZ</td> </tr> <tr> <td>VL1019A0</td> <td>VIBRATION PUMP</td> <td>1</td> <td>PZ</td> </tr> <tr> <td>VL1047A1</td> <td>D6 PIPE HOLDER - D8 J.G. TERMINAL</td> <td>1</td> <td>PZ</td> </tr> <tr> <td>VL1054B0</td> <td>ONE WASHING SYS INLET DISTRIBUTOR</td> <td>1</td> <td>PZ</td> </tr> <tr> <td>VL1102A1</td> <td>DETERGENT LINE FILTER + BARBED VNR 6 MM</td> <td>1</td> <td>PZ</td> </tr> <tr> <td>VL1128A1</td> <td>D6 BARBED CHECK VALVE</td> <td>2</td> <td>PZ</td> </tr> <tr> <td>VL1165A0</td> <td>BB6-AR6 STRAIGHT FITTING</td> <td>1</td> <td>PZ</td> </tr> <tr> <td>VL1166A0</td> <td>BB6-AR6 L FITTING</td> <td>1</td> <td>PZ</td> </tr> <tr> <td>VL1174C0</td> <td>D1.2 MM CALIBRATED NOZZLE</td> <td>1</td> <td>PZ</td> </tr> <tr> <td>VL1191A0</td> <td>ONE WASHING DISTRIBUTOR OUTLETS KIT</td> <td>1</td> <td>PZ</td> </tr> <tr> <td>VM2172A0</td> <td>PUMP-WITH-CI RCUIT LOCKING PIN</td> <td>3</td> <td>PZ</td> </tr> </tbody> </table>	Code	Description	Qty	UOM	GN1526A0	INT. D.=6.9 TH=1.8 O-RIN	3	PZ	RC1018A0	ZINC PLATED D12 ELASTIC CLAMP	2	PZ	RC1019A0	D=10 ELASTIC CLAMP	14	PZ	RC1242A0	D=10 CLOSED CAP	2	PZ	TB2820A0	6X10 EPDM PIPE FOR WASHING SYSTEM	1.460	M	TB3132A0	WHITE-BLUE EPDM TEXTILE BRAID HOSE 6X12	0.670	M	VI1220A1	4,2X12 TCB SELF-TAPPIN G SCREW	4	PZ	VL1019A0	VIBRATION PUMP	1	PZ	VL1047A1	D6 PIPE HOLDER - D8 J.G. TERMINAL	1	PZ	VL1054B0	ONE WASHING SYS INLET DISTRIBUTOR	1	PZ	VL1102A1	DETERGENT LINE FILTER + BARBED VNR 6 MM	1	PZ	VL1128A1	D6 BARBED CHECK VALVE	2	PZ	VL1165A0	BB6-AR6 STRAIGHT FITTING	1	PZ	VL1166A0	BB6-AR6 L FITTING	1	PZ	VL1174C0	D1.2 MM CALIBRATED NOZZLE	1	PZ	VL1191A0	ONE WASHING DISTRIBUTOR OUTLETS KIT	1	PZ	VM2172A0	PUMP-WITH-CI RCUIT LOCKING PIN	3	PZ
Code	Description	Qty	UOM																																																																										
GN1526A0	INT. D.=6.9 TH=1.8 O-RIN	3	PZ																																																																										
RC1018A0	ZINC PLATED D12 ELASTIC CLAMP	2	PZ																																																																										
RC1019A0	D=10 ELASTIC CLAMP	14	PZ																																																																										
RC1242A0	D=10 CLOSED CAP	2	PZ																																																																										
TB2820A0	6X10 EPDM PIPE FOR WASHING SYSTEM	1.460	M																																																																										
TB3132A0	WHITE-BLUE EPDM TEXTILE BRAID HOSE 6X12	0.670	M																																																																										
VI1220A1	4,2X12 TCB SELF-TAPPIN G SCREW	4	PZ																																																																										
VL1019A0	VIBRATION PUMP	1	PZ																																																																										
VL1047A1	D6 PIPE HOLDER - D8 J.G. TERMINAL	1	PZ																																																																										
VL1054B0	ONE WASHING SYS INLET DISTRIBUTOR	1	PZ																																																																										
VL1102A1	DETERGENT LINE FILTER + BARBED VNR 6 MM	1	PZ																																																																										
VL1128A1	D6 BARBED CHECK VALVE	2	PZ																																																																										
VL1165A0	BB6-AR6 STRAIGHT FITTING	1	PZ																																																																										
VL1166A0	BB6-AR6 L FITTING	1	PZ																																																																										
VL1174C0	D1.2 MM CALIBRATED NOZZLE	1	PZ																																																																										
VL1191A0	ONE WASHING DISTRIBUTOR OUTLETS KIT	1	PZ																																																																										
VM2172A0	PUMP-WITH-CI RCUIT LOCKING PIN	3	PZ																																																																										

COMPONENT			SPARE PART																																																																																		
Code	Description	Image	Code	Description	Components list																																																																																
VL1166A	BB6-AR6 L FITTING		KVL1213A	US PLUS COMPACT WASHING SYSTEM KIT	<table border="1"> <thead> <tr> <th>Code</th> <th>Description</th> <th>Qty</th> <th>UOM</th> </tr> </thead> <tbody> <tr> <td>0H2428A0</td> <td></td> <td>1</td> <td>PZ</td> </tr> <tr> <td>EL1450A0</td> <td>US SELF-CLEANING WATER SOLENOID</td> <td>3</td> <td>PZ</td> </tr> <tr> <td>GN1312A0</td> <td>RUBBER CABLE-PASSING DE=26 DI=15 SP=10</td> <td>1</td> <td>PZ</td> </tr> <tr> <td>GN1526A0</td> <td>INT. D.=6.9 TH=1.8 O-RING</td> <td>7</td> <td>PZ</td> </tr> <tr> <td>RC1018A0</td> <td>ZINC PLATED D12 ELASTIC CLAMP</td> <td>3</td> <td>PZ</td> </tr> <tr> <td>RC1019A0</td> <td>D=10 ELASTIC CLAMP</td> <td>14</td> <td>PZ</td> </tr> <tr> <td>RC1130A0</td> <td>130X2,6 CLAM</td> <td>1</td> <td>PZ</td> </tr> <tr> <td>RC1131A0</td> <td>200X2,6 BLACK CLAMP</td> <td>1</td> <td>PZ</td> </tr> <tr> <td>RC1242A0</td> <td>D=10 CLOSED CAP</td> <td>2</td> <td>PZ</td> </tr> <tr> <td>RC1356A0</td> <td>"STRAIGHT THREADED FEMALE END 8X1/4" BS</td> <td>1</td> <td>PZ</td> </tr> <tr> <td>TB2820A0</td> <td>6X10 EPDM PIPE FOR WASHING SYSTEM</td> <td>0.790</td> <td>M</td> </tr> <tr> <td>TB3132A0</td> <td>WHITE-BLUE EPDM TEXTILE BRAID HOSE 6X12</td> <td>1.400</td> <td>M</td> </tr> <tr> <td>VI1220A1</td> <td>4,2X12 TCB SELF-TAPPING SCREW</td> <td>3</td> <td>PZ</td> </tr> <tr> <td>VL1019A0</td> <td>VIBRATION PUMP</td> <td>1</td> <td>PZ</td> </tr> <tr> <td>VL1047A1</td> <td>D6 PIPE HOLDER - D6 J.G. TERMINAL</td> <td>1</td> <td>PZ</td> </tr> <tr> <td>VL1054B0</td> <td>ONE WASHING SYSTEM INLET DISTRIBUTOR</td> <td>1</td> <td>PZ</td> </tr> <tr> <td>VL1065A1</td> <td>1/4 MALE N.O. PRESSURE SWITCH</td> <td>1</td> <td>PZ</td> </tr> <tr> <td>VL1102A1</td> <td>DETERGENT LINE FILTER + BARBED VNR 6 MM</td> <td>1</td> <td>PZ</td> </tr> <tr> <td>VL1128A1</td> <td>D6 BARBED CHECK VALVE</td> <td>2</td> <td>PZ</td> </tr> </tbody> </table>	Code	Description	Qty	UOM	0H2428A0		1	PZ	EL1450A0	US SELF-CLEANING WATER SOLENOID	3	PZ	GN1312A0	RUBBER CABLE-PASSING DE=26 DI=15 SP=10	1	PZ	GN1526A0	INT. D.=6.9 TH=1.8 O-RING	7	PZ	RC1018A0	ZINC PLATED D12 ELASTIC CLAMP	3	PZ	RC1019A0	D=10 ELASTIC CLAMP	14	PZ	RC1130A0	130X2,6 CLAM	1	PZ	RC1131A0	200X2,6 BLACK CLAMP	1	PZ	RC1242A0	D=10 CLOSED CAP	2	PZ	RC1356A0	"STRAIGHT THREADED FEMALE END 8X1/4" BS	1	PZ	TB2820A0	6X10 EPDM PIPE FOR WASHING SYSTEM	0.790	M	TB3132A0	WHITE-BLUE EPDM TEXTILE BRAID HOSE 6X12	1.400	M	VI1220A1	4,2X12 TCB SELF-TAPPING SCREW	3	PZ	VL1019A0	VIBRATION PUMP	1	PZ	VL1047A1	D6 PIPE HOLDER - D6 J.G. TERMINAL	1	PZ	VL1054B0	ONE WASHING SYSTEM INLET DISTRIBUTOR	1	PZ	VL1065A1	1/4 MALE N.O. PRESSURE SWITCH	1	PZ	VL1102A1	DETERGENT LINE FILTER + BARBED VNR 6 MM	1	PZ	VL1128A1	D6 BARBED CHECK VALVE	2	PZ
Code	Description	Qty	UOM																																																																																		
0H2428A0		1	PZ																																																																																		
EL1450A0	US SELF-CLEANING WATER SOLENOID	3	PZ																																																																																		
GN1312A0	RUBBER CABLE-PASSING DE=26 DI=15 SP=10	1	PZ																																																																																		
GN1526A0	INT. D.=6.9 TH=1.8 O-RING	7	PZ																																																																																		
RC1018A0	ZINC PLATED D12 ELASTIC CLAMP	3	PZ																																																																																		
RC1019A0	D=10 ELASTIC CLAMP	14	PZ																																																																																		
RC1130A0	130X2,6 CLAM	1	PZ																																																																																		
RC1131A0	200X2,6 BLACK CLAMP	1	PZ																																																																																		
RC1242A0	D=10 CLOSED CAP	2	PZ																																																																																		
RC1356A0	"STRAIGHT THREADED FEMALE END 8X1/4" BS	1	PZ																																																																																		
TB2820A0	6X10 EPDM PIPE FOR WASHING SYSTEM	0.790	M																																																																																		
TB3132A0	WHITE-BLUE EPDM TEXTILE BRAID HOSE 6X12	1.400	M																																																																																		
VI1220A1	4,2X12 TCB SELF-TAPPING SCREW	3	PZ																																																																																		
VL1019A0	VIBRATION PUMP	1	PZ																																																																																		
VL1047A1	D6 PIPE HOLDER - D6 J.G. TERMINAL	1	PZ																																																																																		
VL1054B0	ONE WASHING SYSTEM INLET DISTRIBUTOR	1	PZ																																																																																		
VL1065A1	1/4 MALE N.O. PRESSURE SWITCH	1	PZ																																																																																		
VL1102A1	DETERGENT LINE FILTER + BARBED VNR 6 MM	1	PZ																																																																																		
VL1128A1	D6 BARBED CHECK VALVE	2	PZ																																																																																		

COMPONENT			SPARE PART																																																																
Code	Description	Image	Code	Description	Components list																																																														
VL1166A	BB6-AR6 L FITTING		KVL1213A	US PLUS COMPACT WASHING SYSTEM KIT	<table border="1"> <thead> <tr> <th>Code</th> <th>Description</th> <th>Qty</th> <th>UOM</th> </tr> </thead> <tbody> <tr> <td>VL1165A0</td> <td>BB6-AR6 STRAIGHT FITTING</td> <td>1</td> <td>PZ</td> </tr> <tr> <td>VL1166A0</td> <td>BB6-AR6 L FITTING</td> <td>3</td> <td>PZ</td> </tr> <tr> <td>VL1174C0</td> <td>D1.2 MM CALIBRATED NOZZLE</td> <td>1</td> <td>PZ</td> </tr> <tr> <td>VL1185A0</td> <td>2 WAYS PLUS WASHING DISTRIBUTOR</td> <td>1</td> <td>PZ</td> </tr> <tr> <td>VM2172A0</td> <td>PUMP-WITH-RCUIT LOCKING PIN</td> <td>6</td> <td>PZ</td> </tr> </tbody> </table>	Code	Description	Qty	UOM	VL1165A0	BB6-AR6 STRAIGHT FITTING	1	PZ	VL1166A0	BB6-AR6 L FITTING	3	PZ	VL1174C0	D1.2 MM CALIBRATED NOZZLE	1	PZ	VL1185A0	2 WAYS PLUS WASHING DISTRIBUTOR	1	PZ	VM2172A0	PUMP-WITH-RCUIT LOCKING PIN	6	PZ																																						
			Code		Description	Qty	UOM																																																												
VL1165A0	BB6-AR6 STRAIGHT FITTING	1	PZ																																																																
VL1166A0	BB6-AR6 L FITTING	3	PZ																																																																
VL1174C0	D1.2 MM CALIBRATED NOZZLE	1	PZ																																																																
VL1185A0	2 WAYS PLUS WASHING DISTRIBUTOR	1	PZ																																																																
VM2172A0	PUMP-WITH-RCUIT LOCKING PIN	6	PZ																																																																
KVL1212A	EUR COMPACT PLUS CLEANING SYSTEM KIT	<table border="1"> <thead> <tr> <th>Code</th> <th>Description</th> <th>Qty</th> <th>UOM</th> </tr> </thead> <tbody> <tr> <td>0H2428A0</td> <td></td> <td>1</td> <td>PZ</td> </tr> <tr> <td>EL1440A0</td> <td>WATER SELF CLEANING VALVE</td> <td>3</td> <td>PZ</td> </tr> <tr> <td>GN1312A0</td> <td>RUBBER CABLE-PASSI NG DE=26 DI=15 SP=10</td> <td>1</td> <td>PZ</td> </tr> <tr> <td>GN1526A0</td> <td>INT. D.=6.9 TH=1.8 O-RING</td> <td>7</td> <td>PZ</td> </tr> <tr> <td>RC1018A0</td> <td>ZINC PLATED D12 ELASTIC CLAMP</td> <td>3</td> <td>PZ</td> </tr> <tr> <td>RC1019A0</td> <td>D=10 ELASTIC CLAMP</td> <td>14</td> <td>PZ</td> </tr> <tr> <td>RC1130A0</td> <td>130X2,6 CLAM</td> <td>1</td> <td>PZ</td> </tr> <tr> <td>RC1131A0</td> <td>200X2.6 BLACK CLAMP</td> <td>1</td> <td>PZ</td> </tr> <tr> <td>RC1242A0</td> <td>D=10 CLOSED CAP</td> <td>2</td> <td>PZ</td> </tr> <tr> <td>RC1356A0</td> <td>"STRAIGHT THREADED FEMALE END 8X1/4" BS</td> <td>1</td> <td>PZ</td> </tr> <tr> <td>TB2820A0</td> <td>6X10 EPDM PIPE FOR WASHING SYSTEM</td> <td>1.340</td> <td>M</td> </tr> <tr> <td>TB3132A0</td> <td>WHITE-BLUE EPDM TEXTILE BRAID HOSE 6X12</td> <td>1.400</td> <td>M</td> </tr> <tr> <td>VI1220A1</td> <td>4,2X12 TCB SELF-TAPPING SCREW</td> <td>3</td> <td>PZ</td> </tr> <tr> <td>VL1019A0</td> <td>VIBRATION PUMP</td> <td>1</td> <td>PZ</td> </tr> <tr> <td>VL1047A1</td> <td>D6 PIPE HOLDER - D8 J.G. TERMINAL</td> <td>1</td> <td>PZ</td> </tr> </tbody> </table>	Code		Description	Qty	UOM	0H2428A0		1	PZ	EL1440A0	WATER SELF CLEANING VALVE	3	PZ	GN1312A0	RUBBER CABLE-PASSI NG DE=26 DI=15 SP=10	1	PZ	GN1526A0	INT. D.=6.9 TH=1.8 O-RING	7	PZ	RC1018A0	ZINC PLATED D12 ELASTIC CLAMP	3	PZ	RC1019A0	D=10 ELASTIC CLAMP	14	PZ	RC1130A0	130X2,6 CLAM	1	PZ	RC1131A0	200X2.6 BLACK CLAMP	1	PZ	RC1242A0	D=10 CLOSED CAP	2	PZ	RC1356A0	"STRAIGHT THREADED FEMALE END 8X1/4" BS	1	PZ	TB2820A0	6X10 EPDM PIPE FOR WASHING SYSTEM	1.340	M	TB3132A0	WHITE-BLUE EPDM TEXTILE BRAID HOSE 6X12	1.400	M	VI1220A1	4,2X12 TCB SELF-TAPPING SCREW	3	PZ	VL1019A0	VIBRATION PUMP	1	PZ	VL1047A1	D6 PIPE HOLDER - D8 J.G. TERMINAL	1	PZ
Code		Description	Qty		UOM																																																														
0H2428A0			1		PZ																																																														
EL1440A0		WATER SELF CLEANING VALVE	3		PZ																																																														
GN1312A0		RUBBER CABLE-PASSI NG DE=26 DI=15 SP=10	1		PZ																																																														
GN1526A0		INT. D.=6.9 TH=1.8 O-RING	7	PZ																																																															
RC1018A0		ZINC PLATED D12 ELASTIC CLAMP	3	PZ																																																															
RC1019A0		D=10 ELASTIC CLAMP	14	PZ																																																															
RC1130A0		130X2,6 CLAM	1	PZ																																																															
RC1131A0		200X2.6 BLACK CLAMP	1	PZ																																																															
RC1242A0		D=10 CLOSED CAP	2	PZ																																																															
RC1356A0	"STRAIGHT THREADED FEMALE END 8X1/4" BS	1	PZ																																																																
TB2820A0	6X10 EPDM PIPE FOR WASHING SYSTEM	1.340	M																																																																
TB3132A0	WHITE-BLUE EPDM TEXTILE BRAID HOSE 6X12	1.400	M																																																																
VI1220A1	4,2X12 TCB SELF-TAPPING SCREW	3	PZ																																																																
VL1019A0	VIBRATION PUMP	1	PZ																																																																
VL1047A1	D6 PIPE HOLDER - D8 J.G. TERMINAL	1	PZ																																																																



COMPONENT			SPARE PART																																																		
Code	Description	Image	Code	Description	Components list																																																
VL1166A	BB6-AR6 L FITTING		KVL1212A	EUR COMPACT PLUS CLEANING SYSTEM KIT	<table border="1"> <thead> <tr> <th>Code</th> <th>Description</th> <th>Qty</th> <th>UOM</th> </tr> </thead> <tbody> <tr> <td>VL1054B0</td> <td>ONE WASHING SYS INLET DISTRIBUTOR</td> <td>1</td> <td>PZ</td> </tr> <tr> <td>VL1065A1</td> <td>1/4 MALE N.O. PRESSURE SWITCH</td> <td>1</td> <td>PZ</td> </tr> <tr> <td>VL1102A1</td> <td>DETERGENT LINE FILTER + BARBED VNR 6 MM</td> <td>1</td> <td>PZ</td> </tr> <tr> <td>VL1128A1</td> <td>D6 BARBED CHECK VALVE</td> <td>2</td> <td>PZ</td> </tr> <tr> <td>VL1165A0</td> <td>BB6-AR6 STRAIGHT FITTING</td> <td>1</td> <td>PZ</td> </tr> <tr> <td>VL1166A0</td> <td>BB6-AR6 L FITTING</td> <td>3</td> <td>PZ</td> </tr> <tr> <td>VL1174C0</td> <td>D1.2 MM CALIBRATED NOZZLE</td> <td>1</td> <td>PZ</td> </tr> <tr> <td>VL1185A0</td> <td>2 WAYS PLUS WASHING DISTRIBUTOR</td> <td>1</td> <td>PZ</td> </tr> <tr> <td>VM2172A0</td> <td>PUMP-WITH-CI RCUIT LOCKING PIN</td> <td>6</td> <td>PZ</td> </tr> </tbody> </table>	Code	Description	Qty	UOM	VL1054B0	ONE WASHING SYS INLET DISTRIBUTOR	1	PZ	VL1065A1	1/4 MALE N.O. PRESSURE SWITCH	1	PZ	VL1102A1	DETERGENT LINE FILTER + BARBED VNR 6 MM	1	PZ	VL1128A1	D6 BARBED CHECK VALVE	2	PZ	VL1165A0	BB6-AR6 STRAIGHT FITTING	1	PZ	VL1166A0	BB6-AR6 L FITTING	3	PZ	VL1174C0	D1.2 MM CALIBRATED NOZZLE	1	PZ	VL1185A0	2 WAYS PLUS WASHING DISTRIBUTOR	1	PZ	VM2172A0	PUMP-WITH-CI RCUIT LOCKING PIN	6	PZ								
Code	Description	Qty	UOM																																																		
VL1054B0	ONE WASHING SYS INLET DISTRIBUTOR	1	PZ																																																		
VL1065A1	1/4 MALE N.O. PRESSURE SWITCH	1	PZ																																																		
VL1102A1	DETERGENT LINE FILTER + BARBED VNR 6 MM	1	PZ																																																		
VL1128A1	D6 BARBED CHECK VALVE	2	PZ																																																		
VL1165A0	BB6-AR6 STRAIGHT FITTING	1	PZ																																																		
VL1166A0	BB6-AR6 L FITTING	3	PZ																																																		
VL1174C0	D1.2 MM CALIBRATED NOZZLE	1	PZ																																																		
VL1185A0	2 WAYS PLUS WASHING DISTRIBUTOR	1	PZ																																																		
VM2172A0	PUMP-WITH-CI RCUIT LOCKING PIN	6	PZ																																																		
			KVL1211A	ONE COMPACT AND 0523-EP WASH. SYSTEM KIT	<table border="1"> <thead> <tr> <th>Code</th> <th>Description</th> <th>Qty</th> <th>UOM</th> </tr> </thead> <tbody> <tr> <td>0H2427A0</td> <td></td> <td>1</td> <td>PZ</td> </tr> <tr> <td>EL1440A0</td> <td>WATER SELF CLEANING VALVE</td> <td>1</td> <td>PZ</td> </tr> <tr> <td>GN1526A0</td> <td>INT. D.=6.9 TH=1.8 O-RIN</td> <td>3</td> <td>PZ</td> </tr> <tr> <td>RC1018A0</td> <td>ZINC PLATED D12 ELASTIC CLAMP</td> <td>2</td> <td>PZ</td> </tr> <tr> <td>RC1019A0</td> <td>D=10 ELASTIC CLAMP</td> <td>14</td> <td>PZ</td> </tr> <tr> <td>RC1130A0</td> <td>130X2,6 CLAM</td> <td>1</td> <td>PZ</td> </tr> <tr> <td>RC1242A0</td> <td>D=10 CLOSED CAP</td> <td>2</td> <td>PZ</td> </tr> <tr> <td>TB2820A0</td> <td>6X10 EPDM PIPE FOR WASHING SYSTEM</td> <td>1.290</td> <td>M</td> </tr> <tr> <td>TB3132A0</td> <td>WHITE-BLUE EPDM TEXTILE BRAID HOSE 6X12</td> <td>0.670</td> <td>M</td> </tr> <tr> <td>VI1220A1</td> <td>4,2X12 TCB SELF-TAPPIN G SCREW</td> <td>4</td> <td>PZ</td> </tr> <tr> <td>VL1019A0</td> <td>VIBRATION PUMP</td> <td>1</td> <td>PZ</td> </tr> </tbody> </table>	Code	Description	Qty	UOM	0H2427A0		1	PZ	EL1440A0	WATER SELF CLEANING VALVE	1	PZ	GN1526A0	INT. D.=6.9 TH=1.8 O-RIN	3	PZ	RC1018A0	ZINC PLATED D12 ELASTIC CLAMP	2	PZ	RC1019A0	D=10 ELASTIC CLAMP	14	PZ	RC1130A0	130X2,6 CLAM	1	PZ	RC1242A0	D=10 CLOSED CAP	2	PZ	TB2820A0	6X10 EPDM PIPE FOR WASHING SYSTEM	1.290	M	TB3132A0	WHITE-BLUE EPDM TEXTILE BRAID HOSE 6X12	0.670	M	VI1220A1	4,2X12 TCB SELF-TAPPIN G SCREW	4	PZ	VL1019A0	VIBRATION PUMP	1	PZ
Code	Description	Qty	UOM																																																		
0H2427A0		1	PZ																																																		
EL1440A0	WATER SELF CLEANING VALVE	1	PZ																																																		
GN1526A0	INT. D.=6.9 TH=1.8 O-RIN	3	PZ																																																		
RC1018A0	ZINC PLATED D12 ELASTIC CLAMP	2	PZ																																																		
RC1019A0	D=10 ELASTIC CLAMP	14	PZ																																																		
RC1130A0	130X2,6 CLAM	1	PZ																																																		
RC1242A0	D=10 CLOSED CAP	2	PZ																																																		
TB2820A0	6X10 EPDM PIPE FOR WASHING SYSTEM	1.290	M																																																		
TB3132A0	WHITE-BLUE EPDM TEXTILE BRAID HOSE 6X12	0.670	M																																																		
VI1220A1	4,2X12 TCB SELF-TAPPIN G SCREW	4	PZ																																																		
VL1019A0	VIBRATION PUMP	1	PZ																																																		

COMPONENT			SPARE PART																																														
Code	Description	Image	Code	Description	Components list																																												
VL1166A	BB6-AR6 L FITTING		KVL1211A	ONE COMPACT AND 0523-EP WASH. SYSTEM KIT	<table border="1"> <thead> <tr> <th>Code</th> <th>Description</th> <th>Qty</th> <th>UOM</th> </tr> </thead> <tbody> <tr> <td>VL1047A1</td> <td>D6 PIPE HOLDER - D8 J.G. TERMINAL</td> <td>1</td> <td>PZ</td> </tr> <tr> <td>VL1054B0</td> <td>ONE WASHING SYS INLET DISTRIBUTOR</td> <td>1</td> <td>PZ</td> </tr> <tr> <td>VL1102A1</td> <td>DETERGENT LINE FILTER + BARBED VNR 6 MM</td> <td>1</td> <td>PZ</td> </tr> <tr> <td>VL1128A1</td> <td>D6 BARBED CHECK VALVE</td> <td>2</td> <td>PZ</td> </tr> <tr> <td>VL1165A0</td> <td>BB6-AR6 STRAIGHT FITTING</td> <td>1</td> <td>PZ</td> </tr> <tr> <td>VL1166A0</td> <td>BB6-AR6 L FITTING</td> <td>1</td> <td>PZ</td> </tr> <tr> <td>VL1174C0</td> <td>D1.2 MM CALIBRATED NOZZLE</td> <td>1</td> <td>PZ</td> </tr> <tr> <td>VL1191A0</td> <td>ONE WASHING DISTRIBUTOR OUTLETS KIT</td> <td>1</td> <td>PZ</td> </tr> <tr> <td>VM2172A0</td> <td>PUMP-WITH-CI RCUIT LOCKING PIN</td> <td>3</td> <td>PZ</td> </tr> </tbody> </table>	Code	Description	Qty	UOM	VL1047A1	D6 PIPE HOLDER - D8 J.G. TERMINAL	1	PZ	VL1054B0	ONE WASHING SYS INLET DISTRIBUTOR	1	PZ	VL1102A1	DETERGENT LINE FILTER + BARBED VNR 6 MM	1	PZ	VL1128A1	D6 BARBED CHECK VALVE	2	PZ	VL1165A0	BB6-AR6 STRAIGHT FITTING	1	PZ	VL1166A0	BB6-AR6 L FITTING	1	PZ	VL1174C0	D1.2 MM CALIBRATED NOZZLE	1	PZ	VL1191A0	ONE WASHING DISTRIBUTOR OUTLETS KIT	1	PZ	VM2172A0	PUMP-WITH-CI RCUIT LOCKING PIN	3	PZ				
Code	Description	Qty	UOM																																														
VL1047A1	D6 PIPE HOLDER - D8 J.G. TERMINAL	1	PZ																																														
VL1054B0	ONE WASHING SYS INLET DISTRIBUTOR	1	PZ																																														
VL1102A1	DETERGENT LINE FILTER + BARBED VNR 6 MM	1	PZ																																														
VL1128A1	D6 BARBED CHECK VALVE	2	PZ																																														
VL1165A0	BB6-AR6 STRAIGHT FITTING	1	PZ																																														
VL1166A0	BB6-AR6 L FITTING	1	PZ																																														
VL1174C0	D1.2 MM CALIBRATED NOZZLE	1	PZ																																														
VL1191A0	ONE WASHING DISTRIBUTOR OUTLETS KIT	1	PZ																																														
VM2172A0	PUMP-WITH-CI RCUIT LOCKING PIN	3	PZ																																														
			KVL1209A	US PLUS 3 ROTOR ARMS WASHING SYSTEM KIT	<table border="1"> <thead> <tr> <th>Code</th> <th>Description</th> <th>Qty</th> <th>UOM</th> </tr> </thead> <tbody> <tr> <td>0H2354A0</td> <td>XEVC-XEVL WASHING CIRCUIT PLAT</td> <td>1</td> <td>PZ</td> </tr> <tr> <td>0H2411A0</td> <td></td> <td>1</td> <td>PZ</td> </tr> <tr> <td>EL1450A0</td> <td>US SELF-CLEANIN G WATER SOLENOID</td> <td>4</td> <td>PZ</td> </tr> <tr> <td>GN1526A0</td> <td>INT. D.=6.9 TH=1.8 O-RIN</td> <td>9</td> <td>PZ</td> </tr> <tr> <td>RC1018A0</td> <td>ZINC PLATED D12 ELASTIC CLAMP</td> <td>13</td> <td>PZ</td> </tr> <tr> <td>RC1019A0</td> <td>D=10 ELASTIC CLAMP</td> <td>15</td> <td>PZ</td> </tr> <tr> <td>RC1130A0</td> <td>130X2.6 CLAM</td> <td>1</td> <td>PZ</td> </tr> <tr> <td>RC1131A0</td> <td>200X2.6 BLACK CLAMP</td> <td>3</td> <td>PZ</td> </tr> <tr> <td>RC1242A0</td> <td>D=10 CLOSED CAP</td> <td>2</td> <td>PZ</td> </tr> <tr> <td>RC1356A0</td> <td>"STRAIGHT THREADED FEMALE END 8X1/4" BS</td> <td>1</td> <td>PZ</td> </tr> </tbody> </table>	Code	Description	Qty	UOM	0H2354A0	XEVC-XEVL WASHING CIRCUIT PLAT	1	PZ	0H2411A0		1	PZ	EL1450A0	US SELF-CLEANIN G WATER SOLENOID	4	PZ	GN1526A0	INT. D.=6.9 TH=1.8 O-RIN	9	PZ	RC1018A0	ZINC PLATED D12 ELASTIC CLAMP	13	PZ	RC1019A0	D=10 ELASTIC CLAMP	15	PZ	RC1130A0	130X2.6 CLAM	1	PZ	RC1131A0	200X2.6 BLACK CLAMP	3	PZ	RC1242A0	D=10 CLOSED CAP	2	PZ	RC1356A0	"STRAIGHT THREADED FEMALE END 8X1/4" BS	1	PZ
Code	Description	Qty	UOM																																														
0H2354A0	XEVC-XEVL WASHING CIRCUIT PLAT	1	PZ																																														
0H2411A0		1	PZ																																														
EL1450A0	US SELF-CLEANIN G WATER SOLENOID	4	PZ																																														
GN1526A0	INT. D.=6.9 TH=1.8 O-RIN	9	PZ																																														
RC1018A0	ZINC PLATED D12 ELASTIC CLAMP	13	PZ																																														
RC1019A0	D=10 ELASTIC CLAMP	15	PZ																																														
RC1130A0	130X2.6 CLAM	1	PZ																																														
RC1131A0	200X2.6 BLACK CLAMP	3	PZ																																														
RC1242A0	D=10 CLOSED CAP	2	PZ																																														
RC1356A0	"STRAIGHT THREADED FEMALE END 8X1/4" BS	1	PZ																																														

COMPONENT			SPARE PART																																																																																		
Code	Description	Image	Code	Description	Components list																																																																																
VL1166A	BB6-AR6 L FITTING		KVL1209A	US PLUS 3 ROTOR ARMS WASHING SYSTEM KIT	<table border="1"> <thead> <tr> <th>Code</th> <th>Description</th> <th>Qty</th> <th>UOM</th> </tr> </thead> <tbody> <tr> <td>TB2820A0</td> <td>6X10 EPDM PIPE FOR WASHING SYSTEM</td> <td>2.750</td> <td>M</td> </tr> <tr> <td>TB3132A0</td> <td>WHITE-BLUE EPDM TEXTILE BRAID HOSE 6X12</td> <td>1.980</td> <td>M</td> </tr> <tr> <td>VI1220A1</td> <td>4,2X12 TCB SELF-TAPPING SCREW</td> <td>3</td> <td>PZ</td> </tr> <tr> <td>VL1019A0</td> <td>VIBRATION PUMP</td> <td>1</td> <td>PZ</td> </tr> <tr> <td>VL1065A1</td> <td>1/4 MALE N.O. PRESSURE SWITCH</td> <td>1</td> <td>PZ</td> </tr> <tr> <td>VL1102A1</td> <td>DETERGENT LINE FILTER + BARBED VNR 6 MM</td> <td>1</td> <td>PZ</td> </tr> <tr> <td>VL1127A1</td> <td>6MM BARBED T-SHAPED FITTING</td> <td>2</td> <td>PZ</td> </tr> <tr> <td>VL1128A1</td> <td>D6 BARBED CHECK VALVE</td> <td>3</td> <td>PZ</td> </tr> <tr> <td>VL1165A0</td> <td>BB6-AR6 STRAIGHT FITTING</td> <td>1</td> <td>PZ</td> </tr> <tr> <td>VL1166A0</td> <td>BB6-AR6 L FITTING</td> <td>4</td> <td>PZ</td> </tr> <tr> <td>VL1167A0</td> <td></td> <td>1</td> <td>PZ</td> </tr> <tr> <td>VL1167A1</td> <td></td> <td>1</td> <td>PZ</td> </tr> <tr> <td>VL1167A2</td> <td>GN21 3 ROTOR ARMS B-B FLOW RESTRICTOR</td> <td>1</td> <td>PZ</td> </tr> <tr> <td>VL1174C0</td> <td>D1.2 MM CALIBRATED NOZZLE</td> <td>1</td> <td>PZ</td> </tr> <tr> <td>VL1185A0</td> <td>2 WAYS PLUS WASHING DISTRIBUTOR</td> <td>1</td> <td>PZ</td> </tr> <tr> <td>VL1186A0</td> <td>3 WAYS PLUS WASHING DISTRIBUTOR</td> <td>1</td> <td>PZ</td> </tr> <tr> <td>VL1190A0</td> <td>PLUS WASHING SYSTEM INLET DISTRIBUTOR</td> <td>1</td> <td>PZ</td> </tr> <tr> <td>VM1605A0</td> <td>CLIP TWIST LOCK DIAM. 10,2-12,7 MM</td> <td>6</td> <td>PZ</td> </tr> <tr> <td>VM2172A0</td> <td>PUMP-WITH-CLIP RCUIT LOCKING PIN</td> <td>9</td> <td>PZ</td> </tr> </tbody> </table>	Code	Description	Qty	UOM	TB2820A0	6X10 EPDM PIPE FOR WASHING SYSTEM	2.750	M	TB3132A0	WHITE-BLUE EPDM TEXTILE BRAID HOSE 6X12	1.980	M	VI1220A1	4,2X12 TCB SELF-TAPPING SCREW	3	PZ	VL1019A0	VIBRATION PUMP	1	PZ	VL1065A1	1/4 MALE N.O. PRESSURE SWITCH	1	PZ	VL1102A1	DETERGENT LINE FILTER + BARBED VNR 6 MM	1	PZ	VL1127A1	6MM BARBED T-SHAPED FITTING	2	PZ	VL1128A1	D6 BARBED CHECK VALVE	3	PZ	VL1165A0	BB6-AR6 STRAIGHT FITTING	1	PZ	VL1166A0	BB6-AR6 L FITTING	4	PZ	VL1167A0		1	PZ	VL1167A1		1	PZ	VL1167A2	GN21 3 ROTOR ARMS B-B FLOW RESTRICTOR	1	PZ	VL1174C0	D1.2 MM CALIBRATED NOZZLE	1	PZ	VL1185A0	2 WAYS PLUS WASHING DISTRIBUTOR	1	PZ	VL1186A0	3 WAYS PLUS WASHING DISTRIBUTOR	1	PZ	VL1190A0	PLUS WASHING SYSTEM INLET DISTRIBUTOR	1	PZ	VM1605A0	CLIP TWIST LOCK DIAM. 10,2-12,7 MM	6	PZ	VM2172A0	PUMP-WITH-CLIP RCUIT LOCKING PIN	9	PZ
Code	Description	Qty	UOM																																																																																		
TB2820A0	6X10 EPDM PIPE FOR WASHING SYSTEM	2.750	M																																																																																		
TB3132A0	WHITE-BLUE EPDM TEXTILE BRAID HOSE 6X12	1.980	M																																																																																		
VI1220A1	4,2X12 TCB SELF-TAPPING SCREW	3	PZ																																																																																		
VL1019A0	VIBRATION PUMP	1	PZ																																																																																		
VL1065A1	1/4 MALE N.O. PRESSURE SWITCH	1	PZ																																																																																		
VL1102A1	DETERGENT LINE FILTER + BARBED VNR 6 MM	1	PZ																																																																																		
VL1127A1	6MM BARBED T-SHAPED FITTING	2	PZ																																																																																		
VL1128A1	D6 BARBED CHECK VALVE	3	PZ																																																																																		
VL1165A0	BB6-AR6 STRAIGHT FITTING	1	PZ																																																																																		
VL1166A0	BB6-AR6 L FITTING	4	PZ																																																																																		
VL1167A0		1	PZ																																																																																		
VL1167A1		1	PZ																																																																																		
VL1167A2	GN21 3 ROTOR ARMS B-B FLOW RESTRICTOR	1	PZ																																																																																		
VL1174C0	D1.2 MM CALIBRATED NOZZLE	1	PZ																																																																																		
VL1185A0	2 WAYS PLUS WASHING DISTRIBUTOR	1	PZ																																																																																		
VL1186A0	3 WAYS PLUS WASHING DISTRIBUTOR	1	PZ																																																																																		
VL1190A0	PLUS WASHING SYSTEM INLET DISTRIBUTOR	1	PZ																																																																																		
VM1605A0	CLIP TWIST LOCK DIAM. 10,2-12,7 MM	6	PZ																																																																																		
VM2172A0	PUMP-WITH-CLIP RCUIT LOCKING PIN	9	PZ																																																																																		





COMPONENT			SPARE PART																																																																																						
Code	Description	Image	Code	Description	Components list																																																																																				
VL1166A	BB6-AR6 L FITTING		KVL1208A	US PLUS 2 ROTOR ARMS WASHING SYSTEM KIT	<table border="1"> <thead> <tr> <th>Code</th> <th>Description</th> <th>Qty</th> <th>UOM</th> </tr> </thead> <tbody> <tr> <td>0H2354A0</td> <td>XEVC-XEVL WASHING CIRCUIT PLAT</td> <td>1</td> <td>PZ</td> </tr> <tr> <td>0H2411A0</td> <td></td> <td>1</td> <td>PZ</td> </tr> <tr> <td>EL1450A0</td> <td>US SELF-CLEANIN G WATER SOLENOID</td> <td>4</td> <td>PZ</td> </tr> <tr> <td>GN1526A0</td> <td>INT. D.=6.9 TH=1.8 O-RIN</td> <td>9</td> <td>PZ</td> </tr> <tr> <td>RC1018A0</td> <td>ZINC PLATED D12 ELASTIC CLAMP</td> <td>4</td> <td>PZ</td> </tr> <tr> <td>RC1019A0</td> <td>D=10 ELASTIC CLAMP</td> <td>16</td> <td>PZ</td> </tr> <tr> <td>RC1130A0</td> <td>130X2,6 CLAM</td> <td>1</td> <td>PZ</td> </tr> <tr> <td>RC1131A0</td> <td>200X2.6 BLACK CLAMP</td> <td>3</td> <td>PZ</td> </tr> <tr> <td>RC1242A0</td> <td>D=10 CLOSED CAP</td> <td>2</td> <td>PZ</td> </tr> <tr> <td>RC1356A0</td> <td>*STRAIGHT THREADED FEMALE END 8X1/4" BS</td> <td>1</td> <td>PZ</td> </tr> <tr> <td>TB2820A0</td> <td>6X10 EPDM PIPE FOR WASHING SYSTEM</td> <td>2.890</td> <td>M</td> </tr> <tr> <td>TB3132A0</td> <td>WHITE-BLUE EPDM TEXTILE BRAID HOSE 6X12</td> <td>1.600</td> <td>M</td> </tr> <tr> <td>VI1220A1</td> <td>4,2X12 TCB SELF-TAPPIN G SCREW</td> <td>3</td> <td>PZ</td> </tr> <tr> <td>VL1019A0</td> <td>VIBRATION PUMP</td> <td>1</td> <td>PZ</td> </tr> <tr> <td>VL1047A1</td> <td>D6 PIPE HOLDER - D8 J.G. TERMINAL</td> <td>1</td> <td>PZ</td> </tr> <tr> <td>VL1065A1</td> <td>1/4 MALE N.O. PRESSURE SWITCH</td> <td>1</td> <td>PZ</td> </tr> <tr> <td>VL1102A1</td> <td>DETERGENT LINE FILTER + BARBED VNR 6 MM</td> <td>1</td> <td>PZ</td> </tr> <tr> <td>VL1128A1</td> <td>D6 BARBED CHECK VALVE</td> <td>2</td> <td>PZ</td> </tr> <tr> <td>VL1141A1</td> <td>STRAIGHT CONNECT BB6-BB6</td> <td>1</td> <td>PZ</td> </tr> <tr> <td>VL1165A0</td> <td>BB6-AR6 STRAIGHT FITTING</td> <td>1</td> <td>PZ</td> </tr> </tbody> </table>	Code	Description	Qty	UOM	0H2354A0	XEVC-XEVL WASHING CIRCUIT PLAT	1	PZ	0H2411A0		1	PZ	EL1450A0	US SELF-CLEANIN G WATER SOLENOID	4	PZ	GN1526A0	INT. D.=6.9 TH=1.8 O-RIN	9	PZ	RC1018A0	ZINC PLATED D12 ELASTIC CLAMP	4	PZ	RC1019A0	D=10 ELASTIC CLAMP	16	PZ	RC1130A0	130X2,6 CLAM	1	PZ	RC1131A0	200X2.6 BLACK CLAMP	3	PZ	RC1242A0	D=10 CLOSED CAP	2	PZ	RC1356A0	*STRAIGHT THREADED FEMALE END 8X1/4" BS	1	PZ	TB2820A0	6X10 EPDM PIPE FOR WASHING SYSTEM	2.890	M	TB3132A0	WHITE-BLUE EPDM TEXTILE BRAID HOSE 6X12	1.600	M	VI1220A1	4,2X12 TCB SELF-TAPPIN G SCREW	3	PZ	VL1019A0	VIBRATION PUMP	1	PZ	VL1047A1	D6 PIPE HOLDER - D8 J.G. TERMINAL	1	PZ	VL1065A1	1/4 MALE N.O. PRESSURE SWITCH	1	PZ	VL1102A1	DETERGENT LINE FILTER + BARBED VNR 6 MM	1	PZ	VL1128A1	D6 BARBED CHECK VALVE	2	PZ	VL1141A1	STRAIGHT CONNECT BB6-BB6	1	PZ	VL1165A0	BB6-AR6 STRAIGHT FITTING	1	PZ
Code	Description	Qty	UOM																																																																																						
0H2354A0	XEVC-XEVL WASHING CIRCUIT PLAT	1	PZ																																																																																						
0H2411A0		1	PZ																																																																																						
EL1450A0	US SELF-CLEANIN G WATER SOLENOID	4	PZ																																																																																						
GN1526A0	INT. D.=6.9 TH=1.8 O-RIN	9	PZ																																																																																						
RC1018A0	ZINC PLATED D12 ELASTIC CLAMP	4	PZ																																																																																						
RC1019A0	D=10 ELASTIC CLAMP	16	PZ																																																																																						
RC1130A0	130X2,6 CLAM	1	PZ																																																																																						
RC1131A0	200X2.6 BLACK CLAMP	3	PZ																																																																																						
RC1242A0	D=10 CLOSED CAP	2	PZ																																																																																						
RC1356A0	*STRAIGHT THREADED FEMALE END 8X1/4" BS	1	PZ																																																																																						
TB2820A0	6X10 EPDM PIPE FOR WASHING SYSTEM	2.890	M																																																																																						
TB3132A0	WHITE-BLUE EPDM TEXTILE BRAID HOSE 6X12	1.600	M																																																																																						
VI1220A1	4,2X12 TCB SELF-TAPPIN G SCREW	3	PZ																																																																																						
VL1019A0	VIBRATION PUMP	1	PZ																																																																																						
VL1047A1	D6 PIPE HOLDER - D8 J.G. TERMINAL	1	PZ																																																																																						
VL1065A1	1/4 MALE N.O. PRESSURE SWITCH	1	PZ																																																																																						
VL1102A1	DETERGENT LINE FILTER + BARBED VNR 6 MM	1	PZ																																																																																						
VL1128A1	D6 BARBED CHECK VALVE	2	PZ																																																																																						
VL1141A1	STRAIGHT CONNECT BB6-BB6	1	PZ																																																																																						
VL1165A0	BB6-AR6 STRAIGHT FITTING	1	PZ																																																																																						



COMPONENT			SPARE PART																																																										
Code	Description	Image	Code	Description	Components list																																																								
VL1166A	BB6-AR6 L FITTING		KVL1208A	US PLUS 2 ROTOR ARMS WASHING SYSTEM KIT	<table border="1"> <thead> <tr> <th>Code</th> <th>Description</th> <th>Qty</th> <th>UOM</th> </tr> </thead> <tbody> <tr> <td>VL1166A0</td> <td>BB6-AR6 L FITTING</td> <td>4</td> <td>PZ</td> </tr> <tr> <td>VL1174C0</td> <td>D1.2 MM CALIBRATED NOZZLE</td> <td>1</td> <td>PZ</td> </tr> <tr> <td>VL1186A0</td> <td>3 WAYS PLUS WASHING DISTRIBUTOR</td> <td>1</td> <td>PZ</td> </tr> <tr> <td>VL1190A0</td> <td>PLUS WASHING SYSTEM INLET DISTRIBUTOR</td> <td>1</td> <td>PZ</td> </tr> <tr> <td>VM1605A0</td> <td>CLIP TWIST LOCK DIAM. 10,2-12,7 MM</td> <td>6</td> <td>PZ</td> </tr> <tr> <td>VM2172A0</td> <td>PUMP-WITH-CI RCUIT LOCKING PIN</td> <td>9</td> <td>PZ</td> </tr> </tbody> </table>	Code	Description	Qty	UOM	VL1166A0	BB6-AR6 L FITTING	4	PZ	VL1174C0	D1.2 MM CALIBRATED NOZZLE	1	PZ	VL1186A0	3 WAYS PLUS WASHING DISTRIBUTOR	1	PZ	VL1190A0	PLUS WASHING SYSTEM INLET DISTRIBUTOR	1	PZ	VM1605A0	CLIP TWIST LOCK DIAM. 10,2-12,7 MM	6	PZ	VM2172A0	PUMP-WITH-CI RCUIT LOCKING PIN	9	PZ																												
Code	Description	Qty	UOM																																																										
VL1166A0	BB6-AR6 L FITTING	4	PZ																																																										
VL1174C0	D1.2 MM CALIBRATED NOZZLE	1	PZ																																																										
VL1186A0	3 WAYS PLUS WASHING DISTRIBUTOR	1	PZ																																																										
VL1190A0	PLUS WASHING SYSTEM INLET DISTRIBUTOR	1	PZ																																																										
VM1605A0	CLIP TWIST LOCK DIAM. 10,2-12,7 MM	6	PZ																																																										
VM2172A0	PUMP-WITH-CI RCUIT LOCKING PIN	9	PZ																																																										
			KVL1207A	US PLUS 1 ROTOR ARM WASHING SYSTEM KIT	<table border="1"> <thead> <tr> <th>Code</th> <th>Description</th> <th>Qty</th> <th>UOM</th> </tr> </thead> <tbody> <tr> <td>0H2354A0</td> <td>XEVC-XEVL WASHING CIRCUIT PLAT</td> <td>1</td> <td>PZ</td> </tr> <tr> <td>0H2411A0</td> <td></td> <td>1</td> <td>PZ</td> </tr> <tr> <td>EL1450A0</td> <td>US SELF-CLEANIN G WATER SOLENOID</td> <td>3</td> <td>PZ</td> </tr> <tr> <td>GN1526A0</td> <td>INT. D.=6.9 TH=1.8 O-RIN</td> <td>7</td> <td>PZ</td> </tr> <tr> <td>RC1018A0</td> <td>ZINC PLATED D12 ELASTIC CLAMP</td> <td>3</td> <td>PZ</td> </tr> <tr> <td>RC1019A0</td> <td>D=10 ELASTIC CLAMP</td> <td>14</td> <td>PZ</td> </tr> <tr> <td>RC1130A0</td> <td>130X2,6 CLAM</td> <td>1</td> <td>PZ</td> </tr> <tr> <td>RC1131A0</td> <td>200X2,6 BLACK CLAMP</td> <td>2</td> <td>PZ</td> </tr> <tr> <td>RC1242A0</td> <td>D=10 CLOSED CAP</td> <td>2</td> <td>PZ</td> </tr> <tr> <td>RC1356A0</td> <td>"STRAIGHT THREADED FEMALE END 8X1/4" BS</td> <td>1</td> <td>PZ</td> </tr> <tr> <td>TB2820A0</td> <td>6X10 EPDM PIPE FOR WASHING SYSTEM</td> <td>1.460</td> <td>M</td> </tr> <tr> <td>TB3132A0</td> <td>WHITE-BLUE EPDM TEXTILE BRAID HOSE 6X12</td> <td>0.770</td> <td>M</td> </tr> <tr> <td>VI1220A1</td> <td>4,2X12 TCB SELF-TAPPIN G SCREW</td> <td>3</td> <td>PZ</td> </tr> </tbody> </table>	Code	Description	Qty	UOM	0H2354A0	XEVC-XEVL WASHING CIRCUIT PLAT	1	PZ	0H2411A0		1	PZ	EL1450A0	US SELF-CLEANIN G WATER SOLENOID	3	PZ	GN1526A0	INT. D.=6.9 TH=1.8 O-RIN	7	PZ	RC1018A0	ZINC PLATED D12 ELASTIC CLAMP	3	PZ	RC1019A0	D=10 ELASTIC CLAMP	14	PZ	RC1130A0	130X2,6 CLAM	1	PZ	RC1131A0	200X2,6 BLACK CLAMP	2	PZ	RC1242A0	D=10 CLOSED CAP	2	PZ	RC1356A0	"STRAIGHT THREADED FEMALE END 8X1/4" BS	1	PZ	TB2820A0	6X10 EPDM PIPE FOR WASHING SYSTEM	1.460	M	TB3132A0	WHITE-BLUE EPDM TEXTILE BRAID HOSE 6X12	0.770	M	VI1220A1	4,2X12 TCB SELF-TAPPIN G SCREW	3	PZ
Code	Description	Qty	UOM																																																										
0H2354A0	XEVC-XEVL WASHING CIRCUIT PLAT	1	PZ																																																										
0H2411A0		1	PZ																																																										
EL1450A0	US SELF-CLEANIN G WATER SOLENOID	3	PZ																																																										
GN1526A0	INT. D.=6.9 TH=1.8 O-RIN	7	PZ																																																										
RC1018A0	ZINC PLATED D12 ELASTIC CLAMP	3	PZ																																																										
RC1019A0	D=10 ELASTIC CLAMP	14	PZ																																																										
RC1130A0	130X2,6 CLAM	1	PZ																																																										
RC1131A0	200X2,6 BLACK CLAMP	2	PZ																																																										
RC1242A0	D=10 CLOSED CAP	2	PZ																																																										
RC1356A0	"STRAIGHT THREADED FEMALE END 8X1/4" BS	1	PZ																																																										
TB2820A0	6X10 EPDM PIPE FOR WASHING SYSTEM	1.460	M																																																										
TB3132A0	WHITE-BLUE EPDM TEXTILE BRAID HOSE 6X12	0.770	M																																																										
VI1220A1	4,2X12 TCB SELF-TAPPIN G SCREW	3	PZ																																																										

COMPONENT			SPARE PART																																																																																									
Code	Description	Image	Code	Description	Components list																																																																																							
VL1166A	BB6-AR6 L FITTING		KVL1207A	US PLUS 1 ROTOR ARM WASHING SYSTEM KIT	<table border="1"> <thead> <tr> <th>Code</th> <th>Description</th> <th>Qty</th> <th>UOM</th> </tr> </thead> <tbody> <tr> <td>VL1019A0</td> <td>VIBRATION PUMP</td> <td>1</td> <td>PZ</td> </tr> <tr> <td>VL1047A1</td> <td>D6 PIPE HOLDER - D8 J.G. TERMINAL</td> <td>1</td> <td>PZ</td> </tr> <tr> <td>VL1065A1</td> <td>1/4 MALE N.O. PRESSURE SWITCH</td> <td>1</td> <td>PZ</td> </tr> <tr> <td>VL1102A1</td> <td>DETERGENT LINE FILTER + BARBED VNR 6 MM</td> <td>1</td> <td>PZ</td> </tr> <tr> <td>VL1128A1</td> <td>D6 BARBED CHECK VALVE</td> <td>2</td> <td>PZ</td> </tr> <tr> <td>VL1165A0</td> <td>BB6-AR6 STRAIGHT FITTING</td> <td>1</td> <td>PZ</td> </tr> <tr> <td>VL1166A0</td> <td>BB6-AR6 L FITTING</td> <td>3</td> <td>PZ</td> </tr> <tr> <td>VL1174C0</td> <td>D1.2 MM CALIBRATED NOZZLE</td> <td>1</td> <td>PZ</td> </tr> <tr> <td>VL1185A0</td> <td>2 WAYS PLUS WASHING DISTRIBUTOR</td> <td>1</td> <td>PZ</td> </tr> <tr> <td>VL1190A0</td> <td>PLUS WASHING SYSTEM INLET DISTRIBUTOR</td> <td>1</td> <td>PZ</td> </tr> <tr> <td>VM1605A0</td> <td>CLIP TWIST LOCK DIAM. 10.2-12.7 MM</td> <td>6</td> <td>PZ</td> </tr> <tr> <td>VM2172A0</td> <td>PUMP-WITH-CI RCUIT LOCKING PIN</td> <td>6</td> <td>PZ</td> </tr> </tbody> </table>	Code	Description	Qty	UOM	VL1019A0	VIBRATION PUMP	1	PZ	VL1047A1	D6 PIPE HOLDER - D8 J.G. TERMINAL	1	PZ	VL1065A1	1/4 MALE N.O. PRESSURE SWITCH	1	PZ	VL1102A1	DETERGENT LINE FILTER + BARBED VNR 6 MM	1	PZ	VL1128A1	D6 BARBED CHECK VALVE	2	PZ	VL1165A0	BB6-AR6 STRAIGHT FITTING	1	PZ	VL1166A0	BB6-AR6 L FITTING	3	PZ	VL1174C0	D1.2 MM CALIBRATED NOZZLE	1	PZ	VL1185A0	2 WAYS PLUS WASHING DISTRIBUTOR	1	PZ	VL1190A0	PLUS WASHING SYSTEM INLET DISTRIBUTOR	1	PZ	VM1605A0	CLIP TWIST LOCK DIAM. 10.2-12.7 MM	6	PZ	VM2172A0	PUMP-WITH-CI RCUIT LOCKING PIN	6	PZ	KVL1198A	MM EU HOOD CLEANING SYSTEM KIT	<table border="1"> <thead> <tr> <th>Code</th> <th>Description</th> <th>Qty</th> <th>UOM</th> </tr> </thead> <tbody> <tr> <td>0H2213A1</td> <td>HOOD WATER CIRCUIT PLAT</td> <td>1</td> <td>PZ</td> </tr> <tr> <td>EL1440A0</td> <td>WATER SELF CLEANING VALVE</td> <td>2</td> <td>PZ</td> </tr> <tr> <td>GN1526A0</td> <td>INT. D.=6.9 TH=1.8 O-RIN</td> <td>5</td> <td>PZ</td> </tr> <tr> <td>RC1018A0</td> <td>ZINC PLATED D12 ELASTIC CLAMP</td> <td>6</td> <td>PZ</td> </tr> <tr> <td>RC1019A0</td> <td>D=10 ELASTIC CLAMP</td> <td>16</td> <td>PZ</td> </tr> <tr> <td>RC1131A0</td> <td>200X2.6 BLACK CLAMP</td> <td>1</td> <td>PZ</td> </tr> <tr> <td>RC1242A0</td> <td>D=10 CLOSED CAP</td> <td>2</td> <td>PZ</td> </tr> </tbody> </table>	Code	Description	Qty	UOM	0H2213A1	HOOD WATER CIRCUIT PLAT	1	PZ	EL1440A0	WATER SELF CLEANING VALVE	2	PZ	GN1526A0	INT. D.=6.9 TH=1.8 O-RIN	5	PZ	RC1018A0	ZINC PLATED D12 ELASTIC CLAMP	6	PZ	RC1019A0	D=10 ELASTIC CLAMP	16	PZ	RC1131A0	200X2.6 BLACK CLAMP	1	PZ	RC1242A0	D=10 CLOSED CAP	2	PZ
					Code	Description	Qty	UOM																																																																																				
VL1019A0	VIBRATION PUMP	1			PZ																																																																																							
VL1047A1	D6 PIPE HOLDER - D8 J.G. TERMINAL	1			PZ																																																																																							
VL1065A1	1/4 MALE N.O. PRESSURE SWITCH	1			PZ																																																																																							
VL1102A1	DETERGENT LINE FILTER + BARBED VNR 6 MM	1			PZ																																																																																							
VL1128A1	D6 BARBED CHECK VALVE	2			PZ																																																																																							
VL1165A0	BB6-AR6 STRAIGHT FITTING	1			PZ																																																																																							
VL1166A0	BB6-AR6 L FITTING	3			PZ																																																																																							
VL1174C0	D1.2 MM CALIBRATED NOZZLE	1			PZ																																																																																							
VL1185A0	2 WAYS PLUS WASHING DISTRIBUTOR	1			PZ																																																																																							
VL1190A0	PLUS WASHING SYSTEM INLET DISTRIBUTOR	1			PZ																																																																																							
VM1605A0	CLIP TWIST LOCK DIAM. 10.2-12.7 MM	6			PZ																																																																																							
VM2172A0	PUMP-WITH-CI RCUIT LOCKING PIN	6			PZ																																																																																							
KVL1198A	MM EU HOOD CLEANING SYSTEM KIT	<table border="1"> <thead> <tr> <th>Code</th> <th>Description</th> <th>Qty</th> <th>UOM</th> </tr> </thead> <tbody> <tr> <td>0H2213A1</td> <td>HOOD WATER CIRCUIT PLAT</td> <td>1</td> <td>PZ</td> </tr> <tr> <td>EL1440A0</td> <td>WATER SELF CLEANING VALVE</td> <td>2</td> <td>PZ</td> </tr> <tr> <td>GN1526A0</td> <td>INT. D.=6.9 TH=1.8 O-RIN</td> <td>5</td> <td>PZ</td> </tr> <tr> <td>RC1018A0</td> <td>ZINC PLATED D12 ELASTIC CLAMP</td> <td>6</td> <td>PZ</td> </tr> <tr> <td>RC1019A0</td> <td>D=10 ELASTIC CLAMP</td> <td>16</td> <td>PZ</td> </tr> <tr> <td>RC1131A0</td> <td>200X2.6 BLACK CLAMP</td> <td>1</td> <td>PZ</td> </tr> <tr> <td>RC1242A0</td> <td>D=10 CLOSED CAP</td> <td>2</td> <td>PZ</td> </tr> </tbody> </table>			Code	Description	Qty	UOM	0H2213A1	HOOD WATER CIRCUIT PLAT	1	PZ	EL1440A0	WATER SELF CLEANING VALVE	2	PZ	GN1526A0	INT. D.=6.9 TH=1.8 O-RIN	5	PZ	RC1018A0	ZINC PLATED D12 ELASTIC CLAMP	6	PZ	RC1019A0	D=10 ELASTIC CLAMP	16	PZ	RC1131A0	200X2.6 BLACK CLAMP	1	PZ	RC1242A0	D=10 CLOSED CAP	2	PZ																																																								
		Code			Description	Qty	UOM																																																																																					
		0H2213A1			HOOD WATER CIRCUIT PLAT	1	PZ																																																																																					
		EL1440A0	WATER SELF CLEANING VALVE	2	PZ																																																																																							
		GN1526A0	INT. D.=6.9 TH=1.8 O-RIN	5	PZ																																																																																							
		RC1018A0	ZINC PLATED D12 ELASTIC CLAMP	6	PZ																																																																																							
		RC1019A0	D=10 ELASTIC CLAMP	16	PZ																																																																																							
		RC1131A0	200X2.6 BLACK CLAMP	1	PZ																																																																																							
		RC1242A0	D=10 CLOSED CAP	2	PZ																																																																																							

COMPONENT			SPARE PART																																																																		
Code	Description	Image	Code	Description	Components list																																																																
VL1166A	BB6-AR6 L FITTING		KVL1198A	MM EU HOOD CLEANING SYSTEM KIT	<table border="1"> <thead> <tr> <th>Code</th> <th>Description</th> <th>Qty</th> <th>UOM</th> </tr> </thead> <tbody> <tr> <td>TB2820A0</td> <td>6X10 EPDM PIPE FOR WASHING SYSTEM</td> <td>2.240</td> <td>M</td> </tr> <tr> <td>TB3132A0</td> <td>WHITE-BLUE EPDM TEXTILE BRAID HOSE 6X12</td> <td>0.440</td> <td>M</td> </tr> <tr> <td>VI1220A1</td> <td>4,2X12 TCB SELF-TAPPIN G SCREW</td> <td>3</td> <td>PZ</td> </tr> <tr> <td>VL1019A0</td> <td>VIBRATION PUMP</td> <td>1</td> <td>PZ</td> </tr> <tr> <td>VL1047A1</td> <td>D6 PIPE HOLDER - D8 J.G. TERMINAL</td> <td>2</td> <td>PZ</td> </tr> <tr> <td>VL1054B0</td> <td>ONE WASHING SYS INLET DISTRIBUTOR</td> <td>1</td> <td>PZ</td> </tr> <tr> <td>VL1102A1</td> <td>DETERGENT LINE FILTER + BARBED VNR 6 MM</td> <td>1</td> <td>PZ</td> </tr> <tr> <td>VL1127A1</td> <td>6MM BARBED T-SHAPED FITTING</td> <td>1</td> <td>PZ</td> </tr> <tr> <td>VL1128A1</td> <td>D6 BARBED CHECK VALVE</td> <td>2</td> <td>PZ</td> </tr> <tr> <td>VL1165A0</td> <td>BB6-AR6 STRAIGHT FITTING</td> <td>2</td> <td>PZ</td> </tr> <tr> <td>VL1166A0</td> <td>BB6-AR6 L FITTING</td> <td>2</td> <td>PZ</td> </tr> <tr> <td>VL1174C0</td> <td>D1.2 MM CALIBRATED NOZZLE</td> <td>1</td> <td>PZ</td> </tr> <tr> <td>VL1191A0</td> <td>ONE WASHING DISTRIBUTOR OUTLETS KIT</td> <td>1</td> <td>PZ</td> </tr> <tr> <td>VM1605A0</td> <td>CLIP TWIST LOCK DIAM. 10,2-12,7 MM</td> <td>4</td> <td>PZ</td> </tr> <tr> <td>VM2172A0</td> <td>PUMP-WITH-CI RCUIT LOCKING PIN</td> <td>5</td> <td>PZ</td> </tr> </tbody> </table>	Code	Description	Qty	UOM	TB2820A0	6X10 EPDM PIPE FOR WASHING SYSTEM	2.240	M	TB3132A0	WHITE-BLUE EPDM TEXTILE BRAID HOSE 6X12	0.440	M	VI1220A1	4,2X12 TCB SELF-TAPPIN G SCREW	3	PZ	VL1019A0	VIBRATION PUMP	1	PZ	VL1047A1	D6 PIPE HOLDER - D8 J.G. TERMINAL	2	PZ	VL1054B0	ONE WASHING SYS INLET DISTRIBUTOR	1	PZ	VL1102A1	DETERGENT LINE FILTER + BARBED VNR 6 MM	1	PZ	VL1127A1	6MM BARBED T-SHAPED FITTING	1	PZ	VL1128A1	D6 BARBED CHECK VALVE	2	PZ	VL1165A0	BB6-AR6 STRAIGHT FITTING	2	PZ	VL1166A0	BB6-AR6 L FITTING	2	PZ	VL1174C0	D1.2 MM CALIBRATED NOZZLE	1	PZ	VL1191A0	ONE WASHING DISTRIBUTOR OUTLETS KIT	1	PZ	VM1605A0	CLIP TWIST LOCK DIAM. 10,2-12,7 MM	4	PZ	VM2172A0	PUMP-WITH-CI RCUIT LOCKING PIN	5	PZ
Code	Description	Qty	UOM																																																																		
TB2820A0	6X10 EPDM PIPE FOR WASHING SYSTEM	2.240	M																																																																		
TB3132A0	WHITE-BLUE EPDM TEXTILE BRAID HOSE 6X12	0.440	M																																																																		
VI1220A1	4,2X12 TCB SELF-TAPPIN G SCREW	3	PZ																																																																		
VL1019A0	VIBRATION PUMP	1	PZ																																																																		
VL1047A1	D6 PIPE HOLDER - D8 J.G. TERMINAL	2	PZ																																																																		
VL1054B0	ONE WASHING SYS INLET DISTRIBUTOR	1	PZ																																																																		
VL1102A1	DETERGENT LINE FILTER + BARBED VNR 6 MM	1	PZ																																																																		
VL1127A1	6MM BARBED T-SHAPED FITTING	1	PZ																																																																		
VL1128A1	D6 BARBED CHECK VALVE	2	PZ																																																																		
VL1165A0	BB6-AR6 STRAIGHT FITTING	2	PZ																																																																		
VL1166A0	BB6-AR6 L FITTING	2	PZ																																																																		
VL1174C0	D1.2 MM CALIBRATED NOZZLE	1	PZ																																																																		
VL1191A0	ONE WASHING DISTRIBUTOR OUTLETS KIT	1	PZ																																																																		
VM1605A0	CLIP TWIST LOCK DIAM. 10,2-12,7 MM	4	PZ																																																																		
VM2172A0	PUMP-WITH-CI RCUIT LOCKING PIN	5	PZ																																																																		
			KVL1187A	3 ROTOR ARMS PLUS EU CLEANING SYSTEM KIT	<table border="1"> <thead> <tr> <th>Code</th> <th>Description</th> <th>Qty</th> <th>UOM</th> </tr> </thead> <tbody> <tr> <td>0H2143A0</td> <td>LAMIERA BLOCCA VNR VL1128</td> <td>3</td> <td>PZ</td> </tr> <tr> <td>0H2168A0</td> <td></td> <td>1</td> <td>PZ</td> </tr> </tbody> </table>	Code	Description	Qty	UOM	0H2143A0	LAMIERA BLOCCA VNR VL1128	3	PZ	0H2168A0		1	PZ																																																				
Code	Description	Qty	UOM																																																																		
0H2143A0	LAMIERA BLOCCA VNR VL1128	3	PZ																																																																		
0H2168A0		1	PZ																																																																		

COMPONENT			SPARE PART																																																																																		
Code	Description	Image	Code	Description	Components list																																																																																
VL1166A	BB6-AR6 L FITTING		KVL1187A	3 ROTOR ARMS PLUS EU CLEANING SYSTEM KIT	<table border="1"> <thead> <tr> <th>Code</th> <th>Description</th> <th>Qty</th> <th>UOM</th> </tr> </thead> <tbody> <tr> <td>0H2354A0</td> <td>XEVC-XEVL WASHING CIRCUIT PLAT</td> <td>1</td> <td>PZ</td> </tr> <tr> <td>EL1120A0</td> <td>D8-D6 FEMALE STRAIGHT INTERM. CONNECTION</td> <td>1</td> <td>PZ</td> </tr> <tr> <td>EL1220A0</td> <td>JG STRAIGHT CONNECTION Ø8F-Ø8F</td> <td>2</td> <td>PZ</td> </tr> <tr> <td>EL1440A0</td> <td>WATER SELF CLEANING VALVE</td> <td>4</td> <td>PZ</td> </tr> <tr> <td>GN1526A0</td> <td>INT. D.=6.9 TH=1.8 O-RIN</td> <td>9</td> <td>PZ</td> </tr> <tr> <td>RC1018A0</td> <td>ZINC PLATED D12 ELASTIC CLAMP</td> <td>10</td> <td>PZ</td> </tr> <tr> <td>RC1019A0</td> <td>D=10 ELASTIC CLAMP</td> <td>22</td> <td>PZ</td> </tr> <tr> <td>RC1130A0</td> <td>130X2,6 CLAM</td> <td>4</td> <td>PZ</td> </tr> <tr> <td>RC1131A0</td> <td>200X2.6 BLACK CLAMP</td> <td>3</td> <td>PZ</td> </tr> <tr> <td>RC1242A0</td> <td>D=10 CLOSED CAP</td> <td>2</td> <td>PZ</td> </tr> <tr> <td>RC1310A0</td> <td>140X4 CLAMP WITH CLIP</td> <td>1</td> <td>PZ</td> </tr> <tr> <td>RC1356A0</td> <td>"STRAIGHT THREADED FEMALE END 8X1/4" BS</td> <td>1</td> <td>PZ</td> </tr> <tr> <td>TB2820A0</td> <td>6X10 EPDM PIPE FOR WASHING SYSTEM</td> <td>1.510</td> <td>M</td> </tr> <tr> <td>TB3132A0</td> <td>WHITE-BLUE EPDM TEXTILE BRAID HOSE 6X12</td> <td>1.210</td> <td>M</td> </tr> <tr> <td>VI1220A1</td> <td>4,2X12 TCB SELF-TAPPIN G SCREW</td> <td>3</td> <td>PZ</td> </tr> <tr> <td>VL1019A0</td> <td>VIBRATION PUMP</td> <td>1</td> <td>PZ</td> </tr> <tr> <td>VL1046A1</td> <td>D6 PIPE HOLDER - D6 J.G. TERMINAL</td> <td>3</td> <td>PZ</td> </tr> <tr> <td>VL1047A1</td> <td>D6 PIPE HOLDER - D8 J.G. TERMINAL</td> <td>1</td> <td>PZ</td> </tr> <tr> <td>VL1064A0</td> <td>WASHING SYSTEM OUTLETS DISTRIBUTOR</td> <td>1</td> <td>PZ</td> </tr> </tbody> </table>	Code	Description	Qty	UOM	0H2354A0	XEVC-XEVL WASHING CIRCUIT PLAT	1	PZ	EL1120A0	D8-D6 FEMALE STRAIGHT INTERM. CONNECTION	1	PZ	EL1220A0	JG STRAIGHT CONNECTION Ø8F-Ø8F	2	PZ	EL1440A0	WATER SELF CLEANING VALVE	4	PZ	GN1526A0	INT. D.=6.9 TH=1.8 O-RIN	9	PZ	RC1018A0	ZINC PLATED D12 ELASTIC CLAMP	10	PZ	RC1019A0	D=10 ELASTIC CLAMP	22	PZ	RC1130A0	130X2,6 CLAM	4	PZ	RC1131A0	200X2.6 BLACK CLAMP	3	PZ	RC1242A0	D=10 CLOSED CAP	2	PZ	RC1310A0	140X4 CLAMP WITH CLIP	1	PZ	RC1356A0	"STRAIGHT THREADED FEMALE END 8X1/4" BS	1	PZ	TB2820A0	6X10 EPDM PIPE FOR WASHING SYSTEM	1.510	M	TB3132A0	WHITE-BLUE EPDM TEXTILE BRAID HOSE 6X12	1.210	M	VI1220A1	4,2X12 TCB SELF-TAPPIN G SCREW	3	PZ	VL1019A0	VIBRATION PUMP	1	PZ	VL1046A1	D6 PIPE HOLDER - D6 J.G. TERMINAL	3	PZ	VL1047A1	D6 PIPE HOLDER - D8 J.G. TERMINAL	1	PZ	VL1064A0	WASHING SYSTEM OUTLETS DISTRIBUTOR	1	PZ
Code	Description	Qty	UOM																																																																																		
0H2354A0	XEVC-XEVL WASHING CIRCUIT PLAT	1	PZ																																																																																		
EL1120A0	D8-D6 FEMALE STRAIGHT INTERM. CONNECTION	1	PZ																																																																																		
EL1220A0	JG STRAIGHT CONNECTION Ø8F-Ø8F	2	PZ																																																																																		
EL1440A0	WATER SELF CLEANING VALVE	4	PZ																																																																																		
GN1526A0	INT. D.=6.9 TH=1.8 O-RIN	9	PZ																																																																																		
RC1018A0	ZINC PLATED D12 ELASTIC CLAMP	10	PZ																																																																																		
RC1019A0	D=10 ELASTIC CLAMP	22	PZ																																																																																		
RC1130A0	130X2,6 CLAM	4	PZ																																																																																		
RC1131A0	200X2.6 BLACK CLAMP	3	PZ																																																																																		
RC1242A0	D=10 CLOSED CAP	2	PZ																																																																																		
RC1310A0	140X4 CLAMP WITH CLIP	1	PZ																																																																																		
RC1356A0	"STRAIGHT THREADED FEMALE END 8X1/4" BS	1	PZ																																																																																		
TB2820A0	6X10 EPDM PIPE FOR WASHING SYSTEM	1.510	M																																																																																		
TB3132A0	WHITE-BLUE EPDM TEXTILE BRAID HOSE 6X12	1.210	M																																																																																		
VI1220A1	4,2X12 TCB SELF-TAPPIN G SCREW	3	PZ																																																																																		
VL1019A0	VIBRATION PUMP	1	PZ																																																																																		
VL1046A1	D6 PIPE HOLDER - D6 J.G. TERMINAL	3	PZ																																																																																		
VL1047A1	D6 PIPE HOLDER - D8 J.G. TERMINAL	1	PZ																																																																																		
VL1064A0	WASHING SYSTEM OUTLETS DISTRIBUTOR	1	PZ																																																																																		







COMPONENT			SPARE PART																																																																														
Code	Description	Image	Code	Description	Components list																																																																												
VL1166A	BB6-AR6 L FITTING		KVL1187A	3 ROTOR ARMS PLUS EU CLEANING SYSTEM KIT	<table border="1"> <thead> <tr> <th>Code</th> <th>Description</th> <th>Qty</th> <th>UOM</th> </tr> </thead> <tbody> <tr> <td>VL1065A1</td> <td>1/4 MALE N.O. PRESSURE SWITCH</td> <td>1</td> <td>PZ</td> </tr> <tr> <td>VL1067A0</td> <td>WASHING SYSTEM INLETS DISTRIBUTOR</td> <td>1</td> <td>PZ</td> </tr> <tr> <td>VL1092A0</td> <td>WASHING SYSTEM OUTLET DOUBLE DISTRIBUTOR</td> <td>1</td> <td>PZ</td> </tr> <tr> <td>VL1102A1</td> <td>DETERGENT LINE FILTER + BARBED VNR 6 MM</td> <td>1</td> <td>PZ</td> </tr> <tr> <td>VL1127A1</td> <td>6MM BARBED T-SHAPED FITTING</td> <td>2</td> <td>PZ</td> </tr> <tr> <td>VL1128A0</td> <td>D6 BARBED CHECK VALVE</td> <td>3</td> <td>PZ</td> </tr> <tr> <td>VL1128A1</td> <td>D6 BARBED CHECK VALVE</td> <td>3</td> <td>PZ</td> </tr> <tr> <td>VL1165A0</td> <td>BB6-AR6 STRAIGHT FITTING</td> <td>4</td> <td>PZ</td> </tr> <tr> <td>VL1166A0</td> <td>BB6-AR6 L FITTING</td> <td>4</td> <td>PZ</td> </tr> <tr> <td>VL1167A0</td> <td></td> <td>1</td> <td>PZ</td> </tr> <tr> <td>VL1167A1</td> <td></td> <td>1</td> <td>PZ</td> </tr> <tr> <td>VL1167A2</td> <td>GN21 3 ROTOR ARMS B-B FLOW RESTRICTOR</td> <td>1</td> <td>PZ</td> </tr> <tr> <td>VL1174C0</td> <td>D1.2 MM CALIBRATED NOZZLE</td> <td>1</td> <td>PZ</td> </tr> <tr> <td>VL1185A0</td> <td>2 WAYS PLUS WASHING DISTRIBUTOR</td> <td>1</td> <td>PZ</td> </tr> <tr> <td>VL1186A0</td> <td>3 WAYS PLUS WASHING DISTRIBUTOR</td> <td>1</td> <td>PZ</td> </tr> <tr> <td>VL1190A0</td> <td>PLUS WASHING SYSTEM INLET DISTRIBUTOR</td> <td>1</td> <td>PZ</td> </tr> <tr> <td>VM1605A0</td> <td>CLIP TWIST LOCK DIAM. 10,2-12,7 MM</td> <td>3</td> <td>PZ</td> </tr> <tr> <td>VM2172A0</td> <td>PUMP-WITH-CI RCUIT LOCKING PIN</td> <td>9</td> <td>PZ</td> </tr> </tbody> </table>	Code	Description	Qty	UOM	VL1065A1	1/4 MALE N.O. PRESSURE SWITCH	1	PZ	VL1067A0	WASHING SYSTEM INLETS DISTRIBUTOR	1	PZ	VL1092A0	WASHING SYSTEM OUTLET DOUBLE DISTRIBUTOR	1	PZ	VL1102A1	DETERGENT LINE FILTER + BARBED VNR 6 MM	1	PZ	VL1127A1	6MM BARBED T-SHAPED FITTING	2	PZ	VL1128A0	D6 BARBED CHECK VALVE	3	PZ	VL1128A1	D6 BARBED CHECK VALVE	3	PZ	VL1165A0	BB6-AR6 STRAIGHT FITTING	4	PZ	VL1166A0	BB6-AR6 L FITTING	4	PZ	VL1167A0		1	PZ	VL1167A1		1	PZ	VL1167A2	GN21 3 ROTOR ARMS B-B FLOW RESTRICTOR	1	PZ	VL1174C0	D1.2 MM CALIBRATED NOZZLE	1	PZ	VL1185A0	2 WAYS PLUS WASHING DISTRIBUTOR	1	PZ	VL1186A0	3 WAYS PLUS WASHING DISTRIBUTOR	1	PZ	VL1190A0	PLUS WASHING SYSTEM INLET DISTRIBUTOR	1	PZ	VM1605A0	CLIP TWIST LOCK DIAM. 10,2-12,7 MM	3	PZ	VM2172A0	PUMP-WITH-CI RCUIT LOCKING PIN	9	PZ
Code	Description	Qty	UOM																																																																														
VL1065A1	1/4 MALE N.O. PRESSURE SWITCH	1	PZ																																																																														
VL1067A0	WASHING SYSTEM INLETS DISTRIBUTOR	1	PZ																																																																														
VL1092A0	WASHING SYSTEM OUTLET DOUBLE DISTRIBUTOR	1	PZ																																																																														
VL1102A1	DETERGENT LINE FILTER + BARBED VNR 6 MM	1	PZ																																																																														
VL1127A1	6MM BARBED T-SHAPED FITTING	2	PZ																																																																														
VL1128A0	D6 BARBED CHECK VALVE	3	PZ																																																																														
VL1128A1	D6 BARBED CHECK VALVE	3	PZ																																																																														
VL1165A0	BB6-AR6 STRAIGHT FITTING	4	PZ																																																																														
VL1166A0	BB6-AR6 L FITTING	4	PZ																																																																														
VL1167A0		1	PZ																																																																														
VL1167A1		1	PZ																																																																														
VL1167A2	GN21 3 ROTOR ARMS B-B FLOW RESTRICTOR	1	PZ																																																																														
VL1174C0	D1.2 MM CALIBRATED NOZZLE	1	PZ																																																																														
VL1185A0	2 WAYS PLUS WASHING DISTRIBUTOR	1	PZ																																																																														
VL1186A0	3 WAYS PLUS WASHING DISTRIBUTOR	1	PZ																																																																														
VL1190A0	PLUS WASHING SYSTEM INLET DISTRIBUTOR	1	PZ																																																																														
VM1605A0	CLIP TWIST LOCK DIAM. 10,2-12,7 MM	3	PZ																																																																														
VM2172A0	PUMP-WITH-CI RCUIT LOCKING PIN	9	PZ																																																																														

COMPONENT			SPARE PART																																																																																		
Code	Description	Image	Code	Description	Components list																																																																																
VL1166A	BB6-AR6 L FITTING		KVL1184A	2 ROTOR ARMS PLUS EU CLEANING SYSTEM KIT	<table border="1"> <thead> <tr> <th>Code</th> <th>Description</th> <th>Qty</th> <th>UOM</th> </tr> </thead> <tbody> <tr> <td>0H2143A0</td> <td>LAMIERA BLOCCA VNR VL1128</td> <td>2</td> <td>PZ</td> </tr> <tr> <td>0H2168A0</td> <td></td> <td>1</td> <td>PZ</td> </tr> <tr> <td>0H2354A0</td> <td>XEVC-XEVL WASHING CIRCUIT PLAT</td> <td>1</td> <td>PZ</td> </tr> <tr> <td>EL1220A0</td> <td>JG STRAIGHT CONNECTION Ø8F-Ø8F</td> <td>3</td> <td>PZ</td> </tr> <tr> <td>EL1440A0</td> <td>WATER SELF CLEANING VALVE</td> <td>4</td> <td>PZ</td> </tr> <tr> <td>GN1526A0</td> <td>INT. D.=6.9 TH=1.8 O-RIN</td> <td>9</td> <td>PZ</td> </tr> <tr> <td>RC1018A0</td> <td>ZINC PLATED D12 ELASTIC CLAMP</td> <td>2</td> <td>PZ</td> </tr> <tr> <td>RC1019A0</td> <td>D=10 ELASTIC CLAMP</td> <td>21</td> <td>PZ</td> </tr> <tr> <td>RC1130A0</td> <td>130X2,6 CLAM</td> <td>7</td> <td>PZ</td> </tr> <tr> <td>RC1131A0</td> <td>200X2.6 BLACK CLAMP</td> <td>3</td> <td>PZ</td> </tr> <tr> <td>RC1242A0</td> <td>D=10 CLOSED CAP</td> <td>2</td> <td>PZ</td> </tr> <tr> <td>RC1356A0</td> <td>"STRAIGHT THREADED FEMALE END 8X1/4" BS</td> <td>1</td> <td>PZ</td> </tr> <tr> <td>TB2820A0</td> <td>6X10 EPDM PIPE FOR WASHING SYSTEM</td> <td>2.400</td> <td>M</td> </tr> <tr> <td>TB3132A0</td> <td>WHITE-BLUE EPDM TEXTILE BRAID HOSE 6X12</td> <td>1.220</td> <td>M</td> </tr> <tr> <td>VL1019A0</td> <td>VIBRATION PUMP</td> <td>1</td> <td>PZ</td> </tr> <tr> <td>VL1046A1</td> <td>D6 PIPE HOLDER - D6 J.G. TERMINAL</td> <td>3</td> <td>PZ</td> </tr> <tr> <td>VL1047A1</td> <td>D6 PIPE HOLDER - D8 J.G. TERMINAL</td> <td>1</td> <td>PZ</td> </tr> <tr> <td>VL1065A1</td> <td>1/4 MALE N.O. PRESSURE SWITCH</td> <td>1</td> <td>PZ</td> </tr> <tr> <td>VL1067A0</td> <td>WASHING SYSTEM INLETS DISTRIBUTOR</td> <td>1</td> <td>PZ</td> </tr> </tbody> </table>	Code	Description	Qty	UOM	0H2143A0	LAMIERA BLOCCA VNR VL1128	2	PZ	0H2168A0		1	PZ	0H2354A0	XEVC-XEVL WASHING CIRCUIT PLAT	1	PZ	EL1220A0	JG STRAIGHT CONNECTION Ø8F-Ø8F	3	PZ	EL1440A0	WATER SELF CLEANING VALVE	4	PZ	GN1526A0	INT. D.=6.9 TH=1.8 O-RIN	9	PZ	RC1018A0	ZINC PLATED D12 ELASTIC CLAMP	2	PZ	RC1019A0	D=10 ELASTIC CLAMP	21	PZ	RC1130A0	130X2,6 CLAM	7	PZ	RC1131A0	200X2.6 BLACK CLAMP	3	PZ	RC1242A0	D=10 CLOSED CAP	2	PZ	RC1356A0	"STRAIGHT THREADED FEMALE END 8X1/4" BS	1	PZ	TB2820A0	6X10 EPDM PIPE FOR WASHING SYSTEM	2.400	M	TB3132A0	WHITE-BLUE EPDM TEXTILE BRAID HOSE 6X12	1.220	M	VL1019A0	VIBRATION PUMP	1	PZ	VL1046A1	D6 PIPE HOLDER - D6 J.G. TERMINAL	3	PZ	VL1047A1	D6 PIPE HOLDER - D8 J.G. TERMINAL	1	PZ	VL1065A1	1/4 MALE N.O. PRESSURE SWITCH	1	PZ	VL1067A0	WASHING SYSTEM INLETS DISTRIBUTOR	1	PZ
Code	Description	Qty	UOM																																																																																		
0H2143A0	LAMIERA BLOCCA VNR VL1128	2	PZ																																																																																		
0H2168A0		1	PZ																																																																																		
0H2354A0	XEVC-XEVL WASHING CIRCUIT PLAT	1	PZ																																																																																		
EL1220A0	JG STRAIGHT CONNECTION Ø8F-Ø8F	3	PZ																																																																																		
EL1440A0	WATER SELF CLEANING VALVE	4	PZ																																																																																		
GN1526A0	INT. D.=6.9 TH=1.8 O-RIN	9	PZ																																																																																		
RC1018A0	ZINC PLATED D12 ELASTIC CLAMP	2	PZ																																																																																		
RC1019A0	D=10 ELASTIC CLAMP	21	PZ																																																																																		
RC1130A0	130X2,6 CLAM	7	PZ																																																																																		
RC1131A0	200X2.6 BLACK CLAMP	3	PZ																																																																																		
RC1242A0	D=10 CLOSED CAP	2	PZ																																																																																		
RC1356A0	"STRAIGHT THREADED FEMALE END 8X1/4" BS	1	PZ																																																																																		
TB2820A0	6X10 EPDM PIPE FOR WASHING SYSTEM	2.400	M																																																																																		
TB3132A0	WHITE-BLUE EPDM TEXTILE BRAID HOSE 6X12	1.220	M																																																																																		
VL1019A0	VIBRATION PUMP	1	PZ																																																																																		
VL1046A1	D6 PIPE HOLDER - D6 J.G. TERMINAL	3	PZ																																																																																		
VL1047A1	D6 PIPE HOLDER - D8 J.G. TERMINAL	1	PZ																																																																																		
VL1065A1	1/4 MALE N.O. PRESSURE SWITCH	1	PZ																																																																																		
VL1067A0	WASHING SYSTEM INLETS DISTRIBUTOR	1	PZ																																																																																		

COMPONENT			SPARE PART																																																						
Code	Description	Image	Code	Description	Components list																																																				
VL1166A	BB6-AR6 L FITTING		KVL1184A	2 ROTOR ARMS PLUS EU CLEANING SYSTEM KIT	<table border="1"> <thead> <tr> <th>Code</th> <th>Description</th> <th>Qty</th> <th>UOM</th> </tr> </thead> <tbody> <tr> <td>VL1092A0</td> <td>WASHING SYSTEM OUTLET DOUBLE DISTRIBUTOR</td> <td>1</td> <td>PZ</td> </tr> <tr> <td>VL1102A1</td> <td>DETERGENT LINE FILTER + BARBED VNR 6 MM</td> <td>1</td> <td>PZ</td> </tr> <tr> <td>VL1128A0</td> <td>D6 BARBED CHECK VALVE</td> <td>2</td> <td>PZ</td> </tr> <tr> <td>VL1128A1</td> <td>D6 BARBED CHECK VALVE</td> <td>2</td> <td>PZ</td> </tr> <tr> <td>VL1141A1</td> <td>STRAIGHT CONNECT BB6-BB6</td> <td>1</td> <td>PZ</td> </tr> <tr> <td>VL1165A0</td> <td>BB6-AR6 STRAIGHT FITTING</td> <td>4</td> <td>PZ</td> </tr> <tr> <td>VL1166A0</td> <td>BB6-AR6 L FITTING</td> <td>4</td> <td>PZ</td> </tr> <tr> <td>VL1174C0</td> <td>D1.2 MM CALIBRATED NOZZLE</td> <td>1</td> <td>PZ</td> </tr> <tr> <td>VL1186A0</td> <td>3 WAYS PLUS WASHING DISTRIBUTOR</td> <td>1</td> <td>PZ</td> </tr> <tr> <td>VL1190A0</td> <td>PLUS WASHING SYSTEM INLET DISTRIBUTOR</td> <td>1</td> <td>PZ</td> </tr> <tr> <td>VM1605A0</td> <td>CLIP TWIST LOCK DIAM. 10,2-12,7 MM</td> <td>4</td> <td>PZ</td> </tr> <tr> <td>VM2172A0</td> <td>PUMP-WITH-CI RCUIT LOCKING PIN</td> <td>9</td> <td>PZ</td> </tr> </tbody> </table>	Code	Description	Qty	UOM	VL1092A0	WASHING SYSTEM OUTLET DOUBLE DISTRIBUTOR	1	PZ	VL1102A1	DETERGENT LINE FILTER + BARBED VNR 6 MM	1	PZ	VL1128A0	D6 BARBED CHECK VALVE	2	PZ	VL1128A1	D6 BARBED CHECK VALVE	2	PZ	VL1141A1	STRAIGHT CONNECT BB6-BB6	1	PZ	VL1165A0	BB6-AR6 STRAIGHT FITTING	4	PZ	VL1166A0	BB6-AR6 L FITTING	4	PZ	VL1174C0	D1.2 MM CALIBRATED NOZZLE	1	PZ	VL1186A0	3 WAYS PLUS WASHING DISTRIBUTOR	1	PZ	VL1190A0	PLUS WASHING SYSTEM INLET DISTRIBUTOR	1	PZ	VM1605A0	CLIP TWIST LOCK DIAM. 10,2-12,7 MM	4	PZ	VM2172A0	PUMP-WITH-CI RCUIT LOCKING PIN	9	PZ
Code	Description	Qty	UOM																																																						
VL1092A0	WASHING SYSTEM OUTLET DOUBLE DISTRIBUTOR	1	PZ																																																						
VL1102A1	DETERGENT LINE FILTER + BARBED VNR 6 MM	1	PZ																																																						
VL1128A0	D6 BARBED CHECK VALVE	2	PZ																																																						
VL1128A1	D6 BARBED CHECK VALVE	2	PZ																																																						
VL1141A1	STRAIGHT CONNECT BB6-BB6	1	PZ																																																						
VL1165A0	BB6-AR6 STRAIGHT FITTING	4	PZ																																																						
VL1166A0	BB6-AR6 L FITTING	4	PZ																																																						
VL1174C0	D1.2 MM CALIBRATED NOZZLE	1	PZ																																																						
VL1186A0	3 WAYS PLUS WASHING DISTRIBUTOR	1	PZ																																																						
VL1190A0	PLUS WASHING SYSTEM INLET DISTRIBUTOR	1	PZ																																																						
VM1605A0	CLIP TWIST LOCK DIAM. 10,2-12,7 MM	4	PZ																																																						
VM2172A0	PUMP-WITH-CI RCUIT LOCKING PIN	9	PZ																																																						
			KVL1183A	1 ROTOR ARM PLUS CLEANING SYSTEM KIT	<table border="1"> <thead> <tr> <th>Code</th> <th>Description</th> <th>Qty</th> <th>UOM</th> </tr> </thead> <tbody> <tr> <td>0H2143A0</td> <td>LAMIERA BLOCCA VNR VL1128</td> <td>2</td> <td>PZ</td> </tr> <tr> <td>0H2168A1</td> <td></td> <td>1</td> <td>PZ</td> </tr> <tr> <td>0H2354A0</td> <td>XEVC-XEVL WASHING CIRCUIT PLAT</td> <td>1</td> <td>PZ</td> </tr> <tr> <td>EL1440A0</td> <td>WATER SELF CLEANING VALVE</td> <td>3</td> <td>PZ</td> </tr> <tr> <td>GN1526A0</td> <td>INT. D.=6.9 TH=1.8 O-RIN</td> <td>7</td> <td>PZ</td> </tr> <tr> <td>RC1018A0</td> <td>ZINC PLATED D12 ELASTIC CLAMP</td> <td>2</td> <td>PZ</td> </tr> </tbody> </table>	Code	Description	Qty	UOM	0H2143A0	LAMIERA BLOCCA VNR VL1128	2	PZ	0H2168A1		1	PZ	0H2354A0	XEVC-XEVL WASHING CIRCUIT PLAT	1	PZ	EL1440A0	WATER SELF CLEANING VALVE	3	PZ	GN1526A0	INT. D.=6.9 TH=1.8 O-RIN	7	PZ	RC1018A0	ZINC PLATED D12 ELASTIC CLAMP	2	PZ																								
Code	Description	Qty	UOM																																																						
0H2143A0	LAMIERA BLOCCA VNR VL1128	2	PZ																																																						
0H2168A1		1	PZ																																																						
0H2354A0	XEVC-XEVL WASHING CIRCUIT PLAT	1	PZ																																																						
EL1440A0	WATER SELF CLEANING VALVE	3	PZ																																																						
GN1526A0	INT. D.=6.9 TH=1.8 O-RIN	7	PZ																																																						
RC1018A0	ZINC PLATED D12 ELASTIC CLAMP	2	PZ																																																						

COMPONENT			SPARE PART																																																																																		
Code	Description	Image	Code	Description	Components list																																																																																
VL1166A	BB6-AR6 L FITTING		KVL1183A	1 ROTOR ARM PLUS CLEANING SYSTEM KIT	<table border="1"> <thead> <tr> <th>Code</th> <th>Description</th> <th>Qty</th> <th>UOM</th> </tr> </thead> <tbody> <tr> <td>RC1019A0</td> <td>D=10 ELASTIC CLAMP</td> <td>14</td> <td>PZ</td> </tr> <tr> <td>RC1130A0</td> <td>130X2,6 CLAM</td> <td>5</td> <td>PZ</td> </tr> <tr> <td>RC1131A0</td> <td>200X2.6 BLACK CLAMP</td> <td>2</td> <td>PZ</td> </tr> <tr> <td>RC1242A0</td> <td>D=10 CLOSED CAP</td> <td>2</td> <td>PZ</td> </tr> <tr> <td>RC1356A0</td> <td>"STRAIGHT THREADED FEMALE END 8X1/4" BS</td> <td>1</td> <td>PZ</td> </tr> <tr> <td>TB2820A0</td> <td>6X10 EPDM PIPE FOR WASHING SYSTEM</td> <td>1.410</td> <td>M</td> </tr> <tr> <td>TB3132A0</td> <td>WHITE-BLUE EPDM TEXTILE BRAID HOSE 6X12</td> <td>0.770</td> <td>M</td> </tr> <tr> <td>VI1220A1</td> <td>4,2X12 TCB SELF-TAPPING SCREW</td> <td>3</td> <td>PZ</td> </tr> <tr> <td>VL1019A0</td> <td>VIBRATION PUMP</td> <td>1</td> <td>PZ</td> </tr> <tr> <td>VL1047A1</td> <td>D6 PIPE HOLDER - D8 J.G. TERMINAL</td> <td>1</td> <td>PZ</td> </tr> <tr> <td>VL1065A1</td> <td>1/4 MALE N.O. PRESSURE SWITCH</td> <td>1</td> <td>PZ</td> </tr> <tr> <td>VL1102A1</td> <td>DETERGENT LINE FILTER + BARBED VNR 6 MM</td> <td>1</td> <td>PZ</td> </tr> <tr> <td>VL1128A0</td> <td>D6 BARBED CHECK VALVE</td> <td>2</td> <td>PZ</td> </tr> <tr> <td>VL1128A1</td> <td>D6 BARBED CHECK VALVE</td> <td>2</td> <td>PZ</td> </tr> <tr> <td>VL1165A0</td> <td>BB6-AR6 STRAIGHT FITTING</td> <td>1</td> <td>PZ</td> </tr> <tr> <td>VL1166A0</td> <td>BB6-AR6 L FITTING</td> <td>3</td> <td>PZ</td> </tr> <tr> <td>VL1174C0</td> <td>D1.2 MM CALIBRATED NOZZLE</td> <td>1</td> <td>PZ</td> </tr> <tr> <td>VL1185A0</td> <td>2 WAYS PLUS WASHING DISTRIBUTOR</td> <td>1</td> <td>PZ</td> </tr> <tr> <td>VL1190A0</td> <td>PLUS WASHING SYSTEM INLET DISTRIBUTOR</td> <td>1</td> <td>PZ</td> </tr> </tbody> </table>	Code	Description	Qty	UOM	RC1019A0	D=10 ELASTIC CLAMP	14	PZ	RC1130A0	130X2,6 CLAM	5	PZ	RC1131A0	200X2.6 BLACK CLAMP	2	PZ	RC1242A0	D=10 CLOSED CAP	2	PZ	RC1356A0	"STRAIGHT THREADED FEMALE END 8X1/4" BS	1	PZ	TB2820A0	6X10 EPDM PIPE FOR WASHING SYSTEM	1.410	M	TB3132A0	WHITE-BLUE EPDM TEXTILE BRAID HOSE 6X12	0.770	M	VI1220A1	4,2X12 TCB SELF-TAPPING SCREW	3	PZ	VL1019A0	VIBRATION PUMP	1	PZ	VL1047A1	D6 PIPE HOLDER - D8 J.G. TERMINAL	1	PZ	VL1065A1	1/4 MALE N.O. PRESSURE SWITCH	1	PZ	VL1102A1	DETERGENT LINE FILTER + BARBED VNR 6 MM	1	PZ	VL1128A0	D6 BARBED CHECK VALVE	2	PZ	VL1128A1	D6 BARBED CHECK VALVE	2	PZ	VL1165A0	BB6-AR6 STRAIGHT FITTING	1	PZ	VL1166A0	BB6-AR6 L FITTING	3	PZ	VL1174C0	D1.2 MM CALIBRATED NOZZLE	1	PZ	VL1185A0	2 WAYS PLUS WASHING DISTRIBUTOR	1	PZ	VL1190A0	PLUS WASHING SYSTEM INLET DISTRIBUTOR	1	PZ
Code	Description	Qty	UOM																																																																																		
RC1019A0	D=10 ELASTIC CLAMP	14	PZ																																																																																		
RC1130A0	130X2,6 CLAM	5	PZ																																																																																		
RC1131A0	200X2.6 BLACK CLAMP	2	PZ																																																																																		
RC1242A0	D=10 CLOSED CAP	2	PZ																																																																																		
RC1356A0	"STRAIGHT THREADED FEMALE END 8X1/4" BS	1	PZ																																																																																		
TB2820A0	6X10 EPDM PIPE FOR WASHING SYSTEM	1.410	M																																																																																		
TB3132A0	WHITE-BLUE EPDM TEXTILE BRAID HOSE 6X12	0.770	M																																																																																		
VI1220A1	4,2X12 TCB SELF-TAPPING SCREW	3	PZ																																																																																		
VL1019A0	VIBRATION PUMP	1	PZ																																																																																		
VL1047A1	D6 PIPE HOLDER - D8 J.G. TERMINAL	1	PZ																																																																																		
VL1065A1	1/4 MALE N.O. PRESSURE SWITCH	1	PZ																																																																																		
VL1102A1	DETERGENT LINE FILTER + BARBED VNR 6 MM	1	PZ																																																																																		
VL1128A0	D6 BARBED CHECK VALVE	2	PZ																																																																																		
VL1128A1	D6 BARBED CHECK VALVE	2	PZ																																																																																		
VL1165A0	BB6-AR6 STRAIGHT FITTING	1	PZ																																																																																		
VL1166A0	BB6-AR6 L FITTING	3	PZ																																																																																		
VL1174C0	D1.2 MM CALIBRATED NOZZLE	1	PZ																																																																																		
VL1185A0	2 WAYS PLUS WASHING DISTRIBUTOR	1	PZ																																																																																		
VL1190A0	PLUS WASHING SYSTEM INLET DISTRIBUTOR	1	PZ																																																																																		

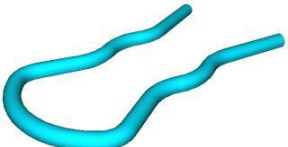
COMPONENT			SPARE PART																																																																						
Code	Description	Image	Code	Description	Components list																																																																				
VL1166A	BB6-AR6 L FITTING		KVL1183A	1 ROTOR ARM PLUS CLEANING SYSTEM KIT	<table border="1"> <thead> <tr> <th>Code</th> <th>Description</th> <th>Qty</th> <th>UOM</th> </tr> </thead> <tbody> <tr> <td>VM1605A0</td> <td>CLIP TWIST LOCK DIAM. 10,2-12,7 MM</td> <td>3</td> <td>PZ</td> </tr> <tr> <td>VM2172A0</td> <td>PUMP-WITH-CI RCUIT LOCKING PIN</td> <td>7</td> <td>PZ</td> </tr> </tbody> </table>	Code	Description	Qty	UOM	VM1605A0	CLIP TWIST LOCK DIAM. 10,2-12,7 MM	3	PZ	VM2172A0	PUMP-WITH-CI RCUIT LOCKING PIN	7	PZ																																																								
Code	Description	Qty	UOM																																																																						
VM1605A0	CLIP TWIST LOCK DIAM. 10,2-12,7 MM	3	PZ																																																																						
VM2172A0	PUMP-WITH-CI RCUIT LOCKING PIN	7	PZ																																																																						
			KVL1182A	ONE CLEANING SYSTEM KIT (0311 EXC.)	<table border="1"> <thead> <tr> <th>Code</th> <th>Description</th> <th>Qty</th> <th>UOM</th> </tr> </thead> <tbody> <tr> <td>0H2143A0</td> <td>LAMIERA BLOCCA VNR VL1128</td> <td>2</td> <td>PZ</td> </tr> <tr> <td>0H2202A1</td> <td>ONE WASHING WITH STEAM VALVE SUPPORT</td> <td>1</td> <td>PZ</td> </tr> <tr> <td>EL1440A0</td> <td>WATER SELF CLEANING VALVE</td> <td>1</td> <td>PZ</td> </tr> <tr> <td>GN1526A0</td> <td>INT. D.=6.9 TH=1.8 O-RIN</td> <td>3</td> <td>PZ</td> </tr> <tr> <td>RC1018A0</td> <td>ZINC PLATED D12 ELASTIC CLAMP</td> <td>1</td> <td>PZ</td> </tr> <tr> <td>RC1019A0</td> <td>D=10 ELASTIC CLAMP</td> <td>14</td> <td>PZ</td> </tr> <tr> <td>RC1130A0</td> <td>130X2,6 CLAM</td> <td>2</td> <td>PZ</td> </tr> <tr> <td>RC1242A0</td> <td>D=10 CLOSED CAP</td> <td>2</td> <td>PZ</td> </tr> <tr> <td>TB2820A0</td> <td>6X10 EPDM PIPE FOR WASHING SYSTEM</td> <td>1.410</td> <td>M</td> </tr> <tr> <td>TB3132A0</td> <td>WHITE-BLUE EPDM TEXTILE BRAID HOSE 6X12</td> <td>0.670</td> <td>M</td> </tr> <tr> <td>VI1220A1</td> <td>4,2X12 TCB SELF-TAPPIN G SCREW</td> <td>1</td> <td>PZ</td> </tr> <tr> <td>VL1019A0</td> <td>VIBRATION PUMP</td> <td>1</td> <td>PZ</td> </tr> <tr> <td>VL1047A1</td> <td>D6 PIPE HOLDER - D8 J.G. TERMINAL</td> <td>1</td> <td>PZ</td> </tr> <tr> <td>VL1054B0</td> <td>ONE WASHING SYS INLET DISTRIBUTOR</td> <td>1</td> <td>PZ</td> </tr> <tr> <td>VL1102A1</td> <td>DETERGENT LINE FILTER + BARBED VNR 6 MM</td> <td>1</td> <td>PZ</td> </tr> <tr> <td>VL1128A0</td> <td>D6 BARBED CHECK VALVE</td> <td>2</td> <td>PZ</td> </tr> </tbody> </table>	Code	Description	Qty	UOM	0H2143A0	LAMIERA BLOCCA VNR VL1128	2	PZ	0H2202A1	ONE WASHING WITH STEAM VALVE SUPPORT	1	PZ	EL1440A0	WATER SELF CLEANING VALVE	1	PZ	GN1526A0	INT. D.=6.9 TH=1.8 O-RIN	3	PZ	RC1018A0	ZINC PLATED D12 ELASTIC CLAMP	1	PZ	RC1019A0	D=10 ELASTIC CLAMP	14	PZ	RC1130A0	130X2,6 CLAM	2	PZ	RC1242A0	D=10 CLOSED CAP	2	PZ	TB2820A0	6X10 EPDM PIPE FOR WASHING SYSTEM	1.410	M	TB3132A0	WHITE-BLUE EPDM TEXTILE BRAID HOSE 6X12	0.670	M	VI1220A1	4,2X12 TCB SELF-TAPPIN G SCREW	1	PZ	VL1019A0	VIBRATION PUMP	1	PZ	VL1047A1	D6 PIPE HOLDER - D8 J.G. TERMINAL	1	PZ	VL1054B0	ONE WASHING SYS INLET DISTRIBUTOR	1	PZ	VL1102A1	DETERGENT LINE FILTER + BARBED VNR 6 MM	1	PZ	VL1128A0	D6 BARBED CHECK VALVE	2	PZ
Code	Description	Qty	UOM																																																																						
0H2143A0	LAMIERA BLOCCA VNR VL1128	2	PZ																																																																						
0H2202A1	ONE WASHING WITH STEAM VALVE SUPPORT	1	PZ																																																																						
EL1440A0	WATER SELF CLEANING VALVE	1	PZ																																																																						
GN1526A0	INT. D.=6.9 TH=1.8 O-RIN	3	PZ																																																																						
RC1018A0	ZINC PLATED D12 ELASTIC CLAMP	1	PZ																																																																						
RC1019A0	D=10 ELASTIC CLAMP	14	PZ																																																																						
RC1130A0	130X2,6 CLAM	2	PZ																																																																						
RC1242A0	D=10 CLOSED CAP	2	PZ																																																																						
TB2820A0	6X10 EPDM PIPE FOR WASHING SYSTEM	1.410	M																																																																						
TB3132A0	WHITE-BLUE EPDM TEXTILE BRAID HOSE 6X12	0.670	M																																																																						
VI1220A1	4,2X12 TCB SELF-TAPPIN G SCREW	1	PZ																																																																						
VL1019A0	VIBRATION PUMP	1	PZ																																																																						
VL1047A1	D6 PIPE HOLDER - D8 J.G. TERMINAL	1	PZ																																																																						
VL1054B0	ONE WASHING SYS INLET DISTRIBUTOR	1	PZ																																																																						
VL1102A1	DETERGENT LINE FILTER + BARBED VNR 6 MM	1	PZ																																																																						
VL1128A0	D6 BARBED CHECK VALVE	2	PZ																																																																						

COMPONENT			SPARE PART																																		
Code	Description	Image	Code	Description	Components list																																
VL1166A	BB6-AR6 L FITTING		KVL1182A	ONE CLEANING SYSTEM KIT (0311 EXC.)	<table border="1"> <thead> <tr> <th>Code</th> <th>Description</th> <th>Qty</th> <th>UOM</th> </tr> </thead> <tbody> <tr> <td>VL1128A1</td> <td>D6 BARBED CHECK VALVE</td> <td>2</td> <td>PZ</td> </tr> <tr> <td>VL1165A0</td> <td>BB6-AR6 STRAIGHT FITTING</td> <td>1</td> <td>PZ</td> </tr> <tr> <td>VL1166A0</td> <td>BB6-AR6 L FITTING</td> <td>1</td> <td>PZ</td> </tr> <tr> <td>VL1174C0</td> <td>D1.2 MM CALIBRATED NOZZLE</td> <td>1</td> <td>PZ</td> </tr> <tr> <td>VL1191A0</td> <td>ONE WASHING DISTRIBUTOR OUTLETS KIT</td> <td>1</td> <td>PZ</td> </tr> <tr> <td>VM1605A0</td> <td>CLIP TWIST LOCK DIAM. 10,2-12,7 MM</td> <td>3</td> <td>PZ</td> </tr> <tr> <td>VM2172A0</td> <td>PUMP-WITH-CIRCUIT RCUIT LOCKING PIN</td> <td>2</td> <td>PZ</td> </tr> </tbody> </table>	Code	Description	Qty	UOM	VL1128A1	D6 BARBED CHECK VALVE	2	PZ	VL1165A0	BB6-AR6 STRAIGHT FITTING	1	PZ	VL1166A0	BB6-AR6 L FITTING	1	PZ	VL1174C0	D1.2 MM CALIBRATED NOZZLE	1	PZ	VL1191A0	ONE WASHING DISTRIBUTOR OUTLETS KIT	1	PZ	VM1605A0	CLIP TWIST LOCK DIAM. 10,2-12,7 MM	3	PZ	VM2172A0	PUMP-WITH-CIRCUIT RCUIT LOCKING PIN	2	PZ
Code	Description	Qty	UOM																																		
VL1128A1	D6 BARBED CHECK VALVE	2	PZ																																		
VL1165A0	BB6-AR6 STRAIGHT FITTING	1	PZ																																		
VL1166A0	BB6-AR6 L FITTING	1	PZ																																		
VL1174C0	D1.2 MM CALIBRATED NOZZLE	1	PZ																																		
VL1191A0	ONE WASHING DISTRIBUTOR OUTLETS KIT	1	PZ																																		
VM1605A0	CLIP TWIST LOCK DIAM. 10,2-12,7 MM	3	PZ																																		
VM2172A0	PUMP-WITH-CIRCUIT RCUIT LOCKING PIN	2	PZ																																		
VM2172A	PUMP-WITH-CIRCUIT LOCKING PIN		VM2172A0	PUMP-WITH-CIRCUIT LOCKING PIN																																	
VL1019A	VIBRATION PUMP		KVL2618A	2 ROTOR ARMS ONE CLEANING SYSTEM KIT	<table border="1"> <thead> <tr> <th>Code</th> <th>Description</th> <th>Qty</th> <th>UOM</th> </tr> </thead> <tbody> <tr> <td>0H2202A1</td> <td>ONE WASHING WITH STEAM VALVE SUPPORT</td> <td>2</td> <td>PZ</td> </tr> <tr> <td>CE1030A0</td> <td>FEMALE FASTON COVER 6,3X0,8 0,5-1MMQ</td> <td>4</td> <td>PZ</td> </tr> <tr> <td>CE1395A0</td> <td>6,3 X 0,8 FEMALE FASTON</td> <td>2</td> <td>PZ</td> </tr> <tr> <td>CE1545A0</td> <td>BLUE UNIP AWG18 ST.3135 WIRE</td> <td>1</td> <td>M</td> </tr> <tr> <td>CE1570A0</td> <td>WHITE UNIP AWG18 ST.3135 WIRE</td> <td>1</td> <td>M</td> </tr> <tr> <td>CE1660A0</td> <td>6,3X0,8 FEMALE FASTON COVER</td> <td>4</td> <td>PZ</td> </tr> <tr> <td>CE1661A0</td> <td>MALE FASTON COVER 6,3X0,</td> <td>2</td> <td>PZ</td> </tr> </tbody> </table>	Code	Description	Qty	UOM	0H2202A1	ONE WASHING WITH STEAM VALVE SUPPORT	2	PZ	CE1030A0	FEMALE FASTON COVER 6,3X0,8 0,5-1MMQ	4	PZ	CE1395A0	6,3 X 0,8 FEMALE FASTON	2	PZ	CE1545A0	BLUE UNIP AWG18 ST.3135 WIRE	1	M	CE1570A0	WHITE UNIP AWG18 ST.3135 WIRE	1	M	CE1660A0	6,3X0,8 FEMALE FASTON COVER	4	PZ	CE1661A0	MALE FASTON COVER 6,3X0,	2	PZ
Code	Description	Qty	UOM																																		
0H2202A1	ONE WASHING WITH STEAM VALVE SUPPORT	2	PZ																																		
CE1030A0	FEMALE FASTON COVER 6,3X0,8 0,5-1MMQ	4	PZ																																		
CE1395A0	6,3 X 0,8 FEMALE FASTON	2	PZ																																		
CE1545A0	BLUE UNIP AWG18 ST.3135 WIRE	1	M																																		
CE1570A0	WHITE UNIP AWG18 ST.3135 WIRE	1	M																																		
CE1660A0	6,3X0,8 FEMALE FASTON COVER	4	PZ																																		
CE1661A0	MALE FASTON COVER 6,3X0,	2	PZ																																		

COMPONENT			SPARE PART																																																																																		
Code	Description	Image	Code	Description	Components list																																																																																
VL1019A	VIBRATION PUMP		KVL2618A	2 ROTOR ARMS ONE CLEANING SYSTEM KIT	<table border="1"> <thead> <tr> <th>Code</th> <th>Description</th> <th>Qty</th> <th>UOM</th> </tr> </thead> <tbody> <tr> <td>EL1020A1</td> <td>D8 INTERMEDIAT E T-SHAPED FITTING</td> <td>1</td> <td>PZ</td> </tr> <tr> <td>EL1440A0</td> <td>WATER SELF CLEANING VALVE</td> <td>2</td> <td>PZ</td> </tr> <tr> <td>GN1526A0</td> <td>INT. D.=6.9 TH=1.8 O-RIN</td> <td>6</td> <td>PZ</td> </tr> <tr> <td>IP1385A1</td> <td>CORNER POLYSTYREN E PACKING 110X80X2000</td> <td>0.500</td> <td>M</td> </tr> <tr> <td>RC1018A0</td> <td>ZINC PLATED D12 ELASTIC CLAMP</td> <td>4</td> <td>PZ</td> </tr> <tr> <td>RC1019A0</td> <td>D=10 ELASTIC CLAMP</td> <td>31</td> <td>PZ</td> </tr> <tr> <td>RC1130A0</td> <td>130X2,6 CLAM</td> <td>4</td> <td>PZ</td> </tr> <tr> <td>RC1242A0</td> <td>D=10 CLOSED CAP</td> <td>4</td> <td>PZ</td> </tr> <tr> <td>TB2820A0</td> <td>6X10 EPDM PIPE FOR WASHING SYSTEM</td> <td>2.920</td> <td>M</td> </tr> <tr> <td>TB3132A0</td> <td>WHITE-BLUE EPDM TEXTILE BRAID HOSE 6X12</td> <td>1.340</td> <td>M</td> </tr> <tr> <td>VI1220A1</td> <td>4,2X12 TCB SELF-TAPPIN G SCREW</td> <td>2</td> <td>PZ</td> </tr> <tr> <td>VL1019A0</td> <td>VIBRATION PUMP</td> <td>2</td> <td>PZ</td> </tr> <tr> <td>VL1047A1</td> <td>D6 PIPE HOLDER - D8 J.G. TERMINAL</td> <td>2</td> <td>PZ</td> </tr> <tr> <td>VL1054B0</td> <td>ONE WASHING SYS INLET DISTRIBUTOR</td> <td>2</td> <td>PZ</td> </tr> <tr> <td>VL1102A1</td> <td>DETERGENT LINE FILTER + BARBED VNR 6 MM</td> <td>2</td> <td>PZ</td> </tr> <tr> <td>VL1127A1</td> <td>6MM BARBED T-SHAPED FITTING</td> <td>1</td> <td>PZ</td> </tr> <tr> <td>VL1128A1</td> <td>D6 BARBED CHECK VALVE</td> <td>4</td> <td>PZ</td> </tr> <tr> <td>VL1165A0</td> <td>BB6-AR6 STRAIGHT FITTING</td> <td>2</td> <td>PZ</td> </tr> <tr> <td>VL1166A0</td> <td>BB6-AR6 L FITTING</td> <td>2</td> <td>PZ</td> </tr> </tbody> </table>	Code	Description	Qty	UOM	EL1020A1	D8 INTERMEDIAT E T-SHAPED FITTING	1	PZ	EL1440A0	WATER SELF CLEANING VALVE	2	PZ	GN1526A0	INT. D.=6.9 TH=1.8 O-RIN	6	PZ	IP1385A1	CORNER POLYSTYREN E PACKING 110X80X2000	0.500	M	RC1018A0	ZINC PLATED D12 ELASTIC CLAMP	4	PZ	RC1019A0	D=10 ELASTIC CLAMP	31	PZ	RC1130A0	130X2,6 CLAM	4	PZ	RC1242A0	D=10 CLOSED CAP	4	PZ	TB2820A0	6X10 EPDM PIPE FOR WASHING SYSTEM	2.920	M	TB3132A0	WHITE-BLUE EPDM TEXTILE BRAID HOSE 6X12	1.340	M	VI1220A1	4,2X12 TCB SELF-TAPPIN G SCREW	2	PZ	VL1019A0	VIBRATION PUMP	2	PZ	VL1047A1	D6 PIPE HOLDER - D8 J.G. TERMINAL	2	PZ	VL1054B0	ONE WASHING SYS INLET DISTRIBUTOR	2	PZ	VL1102A1	DETERGENT LINE FILTER + BARBED VNR 6 MM	2	PZ	VL1127A1	6MM BARBED T-SHAPED FITTING	1	PZ	VL1128A1	D6 BARBED CHECK VALVE	4	PZ	VL1165A0	BB6-AR6 STRAIGHT FITTING	2	PZ	VL1166A0	BB6-AR6 L FITTING	2	PZ
Code	Description	Qty	UOM																																																																																		
EL1020A1	D8 INTERMEDIAT E T-SHAPED FITTING	1	PZ																																																																																		
EL1440A0	WATER SELF CLEANING VALVE	2	PZ																																																																																		
GN1526A0	INT. D.=6.9 TH=1.8 O-RIN	6	PZ																																																																																		
IP1385A1	CORNER POLYSTYREN E PACKING 110X80X2000	0.500	M																																																																																		
RC1018A0	ZINC PLATED D12 ELASTIC CLAMP	4	PZ																																																																																		
RC1019A0	D=10 ELASTIC CLAMP	31	PZ																																																																																		
RC1130A0	130X2,6 CLAM	4	PZ																																																																																		
RC1242A0	D=10 CLOSED CAP	4	PZ																																																																																		
TB2820A0	6X10 EPDM PIPE FOR WASHING SYSTEM	2.920	M																																																																																		
TB3132A0	WHITE-BLUE EPDM TEXTILE BRAID HOSE 6X12	1.340	M																																																																																		
VI1220A1	4,2X12 TCB SELF-TAPPIN G SCREW	2	PZ																																																																																		
VL1019A0	VIBRATION PUMP	2	PZ																																																																																		
VL1047A1	D6 PIPE HOLDER - D8 J.G. TERMINAL	2	PZ																																																																																		
VL1054B0	ONE WASHING SYS INLET DISTRIBUTOR	2	PZ																																																																																		
VL1102A1	DETERGENT LINE FILTER + BARBED VNR 6 MM	2	PZ																																																																																		
VL1127A1	6MM BARBED T-SHAPED FITTING	1	PZ																																																																																		
VL1128A1	D6 BARBED CHECK VALVE	4	PZ																																																																																		
VL1165A0	BB6-AR6 STRAIGHT FITTING	2	PZ																																																																																		
VL1166A0	BB6-AR6 L FITTING	2	PZ																																																																																		

COMPONENT			SPARE PART																																																															
Code	Description	Image	Code	Description	Components list																																																													
VL1019A	VIBRATION PUMP		KVL2618A	2 ROTOR ARMS ONE CLEANING SYSTEM KIT	<table border="1"> <thead> <tr> <th>Code</th> <th>Description</th> <th>Qty</th> <th>UOM</th> </tr> </thead> <tbody> <tr> <td>VL1174C0</td> <td>D1.2 MM CALIBRATED NOZZLE</td> <td>2</td> <td>PZ</td> </tr> <tr> <td>VL1191A0</td> <td>ONE WASHING DISTRIBUTOR OUTLETS KIT</td> <td>2</td> <td>PZ</td> </tr> <tr> <td>VM2172A0</td> <td>PUMP-WITH-CI RCUIT LOCKING PIN</td> <td>4</td> <td>PZ</td> </tr> </tbody> </table>	Code	Description	Qty	UOM	VL1174C0	D1.2 MM CALIBRATED NOZZLE	2	PZ	VL1191A0	ONE WASHING DISTRIBUTOR OUTLETS KIT	2	PZ	VM2172A0	PUMP-WITH-CI RCUIT LOCKING PIN	4	PZ																																													
			Code	Description	Qty	UOM																																																												
VL1174C0	D1.2 MM CALIBRATED NOZZLE	2	PZ																																																															
VL1191A0	ONE WASHING DISTRIBUTOR OUTLETS KIT	2	PZ																																																															
VM2172A0	PUMP-WITH-CI RCUIT LOCKING PIN	4	PZ																																																															
KVL1225A	US HOOD WASHING SYSTEM KIT	<table border="1"> <thead> <tr> <th>Code</th> <th>Description</th> <th>Qty</th> <th>UOM</th> </tr> </thead> <tbody> <tr> <td>0H2213A1</td> <td>HOOD WATER CIRCUIT PLAT</td> <td>1</td> <td>PZ</td> </tr> <tr> <td>EL1450A0</td> <td>US SELF-CLEANIN G WATER SOLENOID</td> <td>2</td> <td>PZ</td> </tr> <tr> <td>GN1526A0</td> <td>INT. D.=6.9 TH=1.8 O-RIN</td> <td>5</td> <td>PZ</td> </tr> <tr> <td>RC1018A0</td> <td>ZINC PLATED D12 ELASTIC CLAMP</td> <td>5</td> <td>PZ</td> </tr> <tr> <td>RC1019A0</td> <td>D=10 ELASTIC CLAMP</td> <td>16</td> <td>PZ</td> </tr> <tr> <td>RC1131A0</td> <td>200X2.6 BLACK CLAMP</td> <td>1</td> <td>PZ</td> </tr> <tr> <td>RC1242A0</td> <td>D=10 CLOSED CAP</td> <td>2</td> <td>PZ</td> </tr> <tr> <td>TB2820A0</td> <td>6X10 EPDM PIPE FOR WASHING SYSTEM</td> <td>2.240</td> <td>M</td> </tr> <tr> <td>TB3132A0</td> <td>WHITE-BLUE EPDM TEXTILE BRAID HOSE 6X12</td> <td>0.440</td> <td>M</td> </tr> <tr> <td>VI1220A1</td> <td>4,2X12 TCB SELF-TAPPIN G SCREW</td> <td>3</td> <td>PZ</td> </tr> <tr> <td>VL1019A0</td> <td>VIBRATION PUMP</td> <td>1</td> <td>PZ</td> </tr> <tr> <td>VL1047A1</td> <td>D6 PIPE HOLDER - D8 J.G. TERMINAL</td> <td>1</td> <td>PZ</td> </tr> <tr> <td>VL1054B0</td> <td>ONE WASHING SYS INLET DISTRIBUTOR</td> <td>1</td> <td>PZ</td> </tr> <tr> <td>VL1102A1</td> <td>DETERGENT LINE FILTER + BARBED VNR 6 MM</td> <td>1</td> <td>PZ</td> </tr> <tr> <td>VL1127A1</td> <td>6MM BARBED T-SHAPED FITTING</td> <td>1</td> <td>PZ</td> </tr> </tbody> </table>	Code	Description	Qty	UOM	0H2213A1	HOOD WATER CIRCUIT PLAT	1	PZ	EL1450A0	US SELF-CLEANIN G WATER SOLENOID	2	PZ	GN1526A0	INT. D.=6.9 TH=1.8 O-RIN	5	PZ	RC1018A0	ZINC PLATED D12 ELASTIC CLAMP	5	PZ	RC1019A0	D=10 ELASTIC CLAMP	16	PZ	RC1131A0	200X2.6 BLACK CLAMP	1	PZ	RC1242A0	D=10 CLOSED CAP	2	PZ	TB2820A0	6X10 EPDM PIPE FOR WASHING SYSTEM	2.240	M	TB3132A0	WHITE-BLUE EPDM TEXTILE BRAID HOSE 6X12	0.440	M	VI1220A1	4,2X12 TCB SELF-TAPPIN G SCREW	3	PZ	VL1019A0	VIBRATION PUMP	1	PZ	VL1047A1	D6 PIPE HOLDER - D8 J.G. TERMINAL	1	PZ	VL1054B0	ONE WASHING SYS INLET DISTRIBUTOR	1	PZ	VL1102A1	DETERGENT LINE FILTER + BARBED VNR 6 MM	1	PZ	VL1127A1	6MM BARBED T-SHAPED FITTING	1	PZ
Code	Description	Qty	UOM																																																															
0H2213A1	HOOD WATER CIRCUIT PLAT	1	PZ																																																															
EL1450A0	US SELF-CLEANIN G WATER SOLENOID	2	PZ																																																															
GN1526A0	INT. D.=6.9 TH=1.8 O-RIN	5	PZ																																																															
RC1018A0	ZINC PLATED D12 ELASTIC CLAMP	5	PZ																																																															
RC1019A0	D=10 ELASTIC CLAMP	16	PZ																																																															
RC1131A0	200X2.6 BLACK CLAMP	1	PZ																																																															
RC1242A0	D=10 CLOSED CAP	2	PZ																																																															
TB2820A0	6X10 EPDM PIPE FOR WASHING SYSTEM	2.240	M																																																															
TB3132A0	WHITE-BLUE EPDM TEXTILE BRAID HOSE 6X12	0.440	M																																																															
VI1220A1	4,2X12 TCB SELF-TAPPIN G SCREW	3	PZ																																																															
VL1019A0	VIBRATION PUMP	1	PZ																																																															
VL1047A1	D6 PIPE HOLDER - D8 J.G. TERMINAL	1	PZ																																																															
VL1054B0	ONE WASHING SYS INLET DISTRIBUTOR	1	PZ																																																															
VL1102A1	DETERGENT LINE FILTER + BARBED VNR 6 MM	1	PZ																																																															
VL1127A1	6MM BARBED T-SHAPED FITTING	1	PZ																																																															

COMPONENT			SPARE PART																																															
Code	Description	Image	Code	Description	Components list																																													
VL1019A	VIBRATION PUMP		KVL1225A	US HOOD WASHING SYSTEM KIT	<table border="1"> <thead> <tr> <th>Code</th> <th>Description</th> <th>Qty</th> <th>UOM</th> </tr> </thead> <tbody> <tr> <td>VL1128A1</td> <td>D6 BARBED CHECK VALVE</td> <td>2</td> <td>PZ</td> </tr> <tr> <td>VL1165A0</td> <td>BB6-AR6 STRAIGHT FITTING</td> <td>2</td> <td>PZ</td> </tr> <tr> <td>VL1166A0</td> <td>BB6-AR6 L FITTING</td> <td>2</td> <td>PZ</td> </tr> <tr> <td>VL1174C0</td> <td>D1.2 MM CALIBRATED NOZZLE</td> <td>1</td> <td>PZ</td> </tr> <tr> <td>VL1191A0</td> <td>ONE WASHING DISTRIBUTOR OUTLETS KIT</td> <td>1</td> <td>PZ</td> </tr> <tr> <td>VM1605A0</td> <td>CLIP TWIST LOCK DIAM. 10,2-12,7 MM</td> <td>2</td> <td>PZ</td> </tr> <tr> <td>VM2172A0</td> <td>PUMP-WITH-CI RCUIT LOCKING PIN</td> <td>5</td> <td>PZ</td> </tr> </tbody> </table>	Code	Description	Qty	UOM	VL1128A1	D6 BARBED CHECK VALVE	2	PZ	VL1165A0	BB6-AR6 STRAIGHT FITTING	2	PZ	VL1166A0	BB6-AR6 L FITTING	2	PZ	VL1174C0	D1.2 MM CALIBRATED NOZZLE	1	PZ	VL1191A0	ONE WASHING DISTRIBUTOR OUTLETS KIT	1	PZ	VM1605A0	CLIP TWIST LOCK DIAM. 10,2-12,7 MM	2	PZ	VM2172A0	PUMP-WITH-CI RCUIT LOCKING PIN	5	PZ													
			Code	Description	Qty	UOM																																												
VL1128A1	D6 BARBED CHECK VALVE	2	PZ																																															
VL1165A0	BB6-AR6 STRAIGHT FITTING	2	PZ																																															
VL1166A0	BB6-AR6 L FITTING	2	PZ																																															
VL1174C0	D1.2 MM CALIBRATED NOZZLE	1	PZ																																															
VL1191A0	ONE WASHING DISTRIBUTOR OUTLETS KIT	1	PZ																																															
VM1605A0	CLIP TWIST LOCK DIAM. 10,2-12,7 MM	2	PZ																																															
VM2172A0	PUMP-WITH-CI RCUIT LOCKING PIN	5	PZ																																															
KVL1222A	EUR 0311 ONE PLUS CLEANING SYSTEM KIT	<table border="1"> <thead> <tr> <th>Code</th> <th>Description</th> <th>Qty</th> <th>UOM</th> </tr> </thead> <tbody> <tr> <td>0H2486A0</td> <td>0311 WASHING CIRCUIT PLAT</td> <td>1</td> <td>PZ</td> </tr> <tr> <td>EL1440A0</td> <td>WATER SELF CLEANING VALVE</td> <td>1</td> <td>PZ</td> </tr> <tr> <td>GN1526A0</td> <td>INT. D.=6.9 TH=1.8 O-RIN</td> <td>3</td> <td>PZ</td> </tr> <tr> <td>RC1018A0</td> <td>ZINC PLATED D12 ELASTIC CLAMP</td> <td>2</td> <td>PZ</td> </tr> <tr> <td>RC1019A0</td> <td>D=10 ELASTIC CLAMP</td> <td>14</td> <td>PZ</td> </tr> <tr> <td>RC1242A0</td> <td>D=10 CLOSED CAP</td> <td>2</td> <td>PZ</td> </tr> <tr> <td>TB2820A0</td> <td>6X10 EPDM PIPE FOR WASHING SYSTEM</td> <td>1.460</td> <td>M</td> </tr> <tr> <td>TB3132A0</td> <td>WHITE-BLUE EPDM TEXTILE BRAID HOSE 6X12</td> <td>0.670</td> <td>M</td> </tr> <tr> <td>VI1220A1</td> <td>4,2X12 TCB SELF-TAPPIN G SCREW</td> <td>4</td> <td>PZ</td> </tr> <tr> <td>VL1019A0</td> <td>VIBRATION PUMP</td> <td>1</td> <td>PZ</td> </tr> <tr> <td>VL1047A1</td> <td>D6 PIPE HOLDER - D8 J.G. TERMINAL</td> <td>1</td> <td>PZ</td> </tr> </tbody> </table>	Code	Description	Qty	UOM	0H2486A0	0311 WASHING CIRCUIT PLAT	1	PZ	EL1440A0	WATER SELF CLEANING VALVE	1	PZ	GN1526A0	INT. D.=6.9 TH=1.8 O-RIN	3	PZ	RC1018A0	ZINC PLATED D12 ELASTIC CLAMP	2	PZ	RC1019A0	D=10 ELASTIC CLAMP	14	PZ	RC1242A0	D=10 CLOSED CAP	2	PZ	TB2820A0	6X10 EPDM PIPE FOR WASHING SYSTEM	1.460	M	TB3132A0	WHITE-BLUE EPDM TEXTILE BRAID HOSE 6X12	0.670	M	VI1220A1	4,2X12 TCB SELF-TAPPIN G SCREW	4	PZ	VL1019A0	VIBRATION PUMP	1	PZ	VL1047A1	D6 PIPE HOLDER - D8 J.G. TERMINAL	1	PZ
Code	Description	Qty	UOM																																															
0H2486A0	0311 WASHING CIRCUIT PLAT	1	PZ																																															
EL1440A0	WATER SELF CLEANING VALVE	1	PZ																																															
GN1526A0	INT. D.=6.9 TH=1.8 O-RIN	3	PZ																																															
RC1018A0	ZINC PLATED D12 ELASTIC CLAMP	2	PZ																																															
RC1019A0	D=10 ELASTIC CLAMP	14	PZ																																															
RC1242A0	D=10 CLOSED CAP	2	PZ																																															
TB2820A0	6X10 EPDM PIPE FOR WASHING SYSTEM	1.460	M																																															
TB3132A0	WHITE-BLUE EPDM TEXTILE BRAID HOSE 6X12	0.670	M																																															
VI1220A1	4,2X12 TCB SELF-TAPPIN G SCREW	4	PZ																																															
VL1019A0	VIBRATION PUMP	1	PZ																																															
VL1047A1	D6 PIPE HOLDER - D8 J.G. TERMINAL	1	PZ																																															

COMPONENT			SPARE PART																																																		
Code	Description	Image	Code	Description	Components list																																																
VL1019A	VIBRATION PUMP		KVL1222A	EUR 0311 ONE PLUS CLEANING SYSTEM KIT	<table border="1"> <thead> <tr> <th>Code</th> <th>Description</th> <th>Qty</th> <th>UOM</th> </tr> </thead> <tbody> <tr> <td>VL1054B0</td> <td>ONE WASHING SYS INLET DISTRIBUTOR</td> <td>1</td> <td>PZ</td> </tr> <tr> <td>VL1102A1</td> <td>DETERGENT LINE FILTER + BARBED VNR 6 MM</td> <td>1</td> <td>PZ</td> </tr> <tr> <td>VL1128A1</td> <td>D6 BARBED CHECK VALVE</td> <td>2</td> <td>PZ</td> </tr> <tr> <td>VL1165A0</td> <td>BB6-AR6 STRAIGHT FITTING</td> <td>1</td> <td>PZ</td> </tr> <tr> <td>VL1166A0</td> <td>BB6-AR6 L FITTING</td> <td>1</td> <td>PZ</td> </tr> <tr> <td>VL1174C0</td> <td>D1.2 MM CALIBRATED NOZZLE</td> <td>1</td> <td>PZ</td> </tr> <tr> <td>VL1191A0</td> <td>ONE WASHING DISTRIBUTOR OUTLETS KIT</td> <td>1</td> <td>PZ</td> </tr> <tr> <td>VM2172A0</td> <td>PUMP-WITH-CI RCUIT LOCKING PIN</td> <td>3</td> <td>PZ</td> </tr> </tbody> </table>	Code	Description	Qty	UOM	VL1054B0	ONE WASHING SYS INLET DISTRIBUTOR	1	PZ	VL1102A1	DETERGENT LINE FILTER + BARBED VNR 6 MM	1	PZ	VL1128A1	D6 BARBED CHECK VALVE	2	PZ	VL1165A0	BB6-AR6 STRAIGHT FITTING	1	PZ	VL1166A0	BB6-AR6 L FITTING	1	PZ	VL1174C0	D1.2 MM CALIBRATED NOZZLE	1	PZ	VL1191A0	ONE WASHING DISTRIBUTOR OUTLETS KIT	1	PZ	VM2172A0	PUMP-WITH-CI RCUIT LOCKING PIN	3	PZ												
Code	Description	Qty	UOM																																																		
VL1054B0	ONE WASHING SYS INLET DISTRIBUTOR	1	PZ																																																		
VL1102A1	DETERGENT LINE FILTER + BARBED VNR 6 MM	1	PZ																																																		
VL1128A1	D6 BARBED CHECK VALVE	2	PZ																																																		
VL1165A0	BB6-AR6 STRAIGHT FITTING	1	PZ																																																		
VL1166A0	BB6-AR6 L FITTING	1	PZ																																																		
VL1174C0	D1.2 MM CALIBRATED NOZZLE	1	PZ																																																		
VL1191A0	ONE WASHING DISTRIBUTOR OUTLETS KIT	1	PZ																																																		
VM2172A0	PUMP-WITH-CI RCUIT LOCKING PIN	3	PZ																																																		
			KVL1213A	US PLUS COMPACT WASHING SYSTEM KIT	<table border="1"> <thead> <tr> <th>Code</th> <th>Description</th> <th>Qty</th> <th>UOM</th> </tr> </thead> <tbody> <tr> <td>0H2428A0</td> <td></td> <td>1</td> <td>PZ</td> </tr> <tr> <td>EL1450A0</td> <td>US SELF-CLEANIN G WATER SOLENOID</td> <td>3</td> <td>PZ</td> </tr> <tr> <td>GN1312A0</td> <td>RUBBER CABLE-PASSI NG DE=26 DI=15 SP=10</td> <td>1</td> <td>PZ</td> </tr> <tr> <td>GN1526A0</td> <td>INT. D.=6.9 TH=1.8 O-RIN</td> <td>7</td> <td>PZ</td> </tr> <tr> <td>RC1018A0</td> <td>ZINC PLATED D12 ELASTIC CLAMP</td> <td>3</td> <td>PZ</td> </tr> <tr> <td>RC1019A0</td> <td>D=10 ELASTIC CLAMP</td> <td>14</td> <td>PZ</td> </tr> <tr> <td>RC1130A0</td> <td>130X2.6 CLAM</td> <td>1</td> <td>PZ</td> </tr> <tr> <td>RC1131A0</td> <td>200X2.6 BLACK CLAMP</td> <td>1</td> <td>PZ</td> </tr> <tr> <td>RC1242A0</td> <td>D=10 CLOSED CAP</td> <td>2</td> <td>PZ</td> </tr> <tr> <td>RC1356A0</td> <td>"STRAIGHT THREADED FEMALE END 8X1/4" BS</td> <td>1</td> <td>PZ</td> </tr> <tr> <td>TB2820A0</td> <td>6X10 EPDM PIPE FOR WASHING SYSTEM</td> <td>0.790</td> <td>M</td> </tr> </tbody> </table>	Code	Description	Qty	UOM	0H2428A0		1	PZ	EL1450A0	US SELF-CLEANIN G WATER SOLENOID	3	PZ	GN1312A0	RUBBER CABLE-PASSI NG DE=26 DI=15 SP=10	1	PZ	GN1526A0	INT. D.=6.9 TH=1.8 O-RIN	7	PZ	RC1018A0	ZINC PLATED D12 ELASTIC CLAMP	3	PZ	RC1019A0	D=10 ELASTIC CLAMP	14	PZ	RC1130A0	130X2.6 CLAM	1	PZ	RC1131A0	200X2.6 BLACK CLAMP	1	PZ	RC1242A0	D=10 CLOSED CAP	2	PZ	RC1356A0	"STRAIGHT THREADED FEMALE END 8X1/4" BS	1	PZ	TB2820A0	6X10 EPDM PIPE FOR WASHING SYSTEM	0.790	M
Code	Description	Qty	UOM																																																		
0H2428A0		1	PZ																																																		
EL1450A0	US SELF-CLEANIN G WATER SOLENOID	3	PZ																																																		
GN1312A0	RUBBER CABLE-PASSI NG DE=26 DI=15 SP=10	1	PZ																																																		
GN1526A0	INT. D.=6.9 TH=1.8 O-RIN	7	PZ																																																		
RC1018A0	ZINC PLATED D12 ELASTIC CLAMP	3	PZ																																																		
RC1019A0	D=10 ELASTIC CLAMP	14	PZ																																																		
RC1130A0	130X2.6 CLAM	1	PZ																																																		
RC1131A0	200X2.6 BLACK CLAMP	1	PZ																																																		
RC1242A0	D=10 CLOSED CAP	2	PZ																																																		
RC1356A0	"STRAIGHT THREADED FEMALE END 8X1/4" BS	1	PZ																																																		
TB2820A0	6X10 EPDM PIPE FOR WASHING SYSTEM	0.790	M																																																		

COMPONENT			SPARE PART																																																																																					
Code	Description	Image	Code	Description	Components list																																																																																			
VL1019A	VIBRATION PUMP		KVL1213A	US PLUS COMPACT WASHING SYSTEM KIT	<table border="1"> <thead> <tr> <th>Code</th> <th>Description</th> <th>Qty</th> <th>UOM</th> </tr> </thead> <tbody> <tr> <td>TB3132A0</td> <td>WHITE-BLUE EPDM TEXTILE BRAID HOSE 6X12</td> <td>1.400</td> <td>M</td> </tr> <tr> <td>V11220A1</td> <td>4,2X12 TCB SELF-TAPPING SCREW</td> <td>3</td> <td>PZ</td> </tr> <tr> <td>VL1019A0</td> <td>VIBRATION PUMP</td> <td>1</td> <td>PZ</td> </tr> <tr> <td>VL1047A1</td> <td>D6 PIPE HOLDER - D8 J.G. TERMINAL</td> <td>1</td> <td>PZ</td> </tr> <tr> <td>VL1054B0</td> <td>ONE WASHING SYSTEM INLET DISTRIBUTOR</td> <td>1</td> <td>PZ</td> </tr> <tr> <td>VL1065A1</td> <td>1/4 MALE N.O. PRESSURE SWITCH</td> <td>1</td> <td>PZ</td> </tr> <tr> <td>VL1102A1</td> <td>DETERGENT LINE FILTER + BARBED VNR 6 MM</td> <td>1</td> <td>PZ</td> </tr> <tr> <td>VL1128A1</td> <td>D6 BARBED CHECK VALVE</td> <td>2</td> <td>PZ</td> </tr> <tr> <td>VL1165A0</td> <td>BB6-AR6 STRAIGHT FITTING</td> <td>1</td> <td>PZ</td> </tr> <tr> <td>VL1166A0</td> <td>BB6-AR6 L FITTING</td> <td>3</td> <td>PZ</td> </tr> <tr> <td>VL1174C0</td> <td>D1.2 MM CALIBRATED NOZZLE</td> <td>1</td> <td>PZ</td> </tr> <tr> <td>VL1185A0</td> <td>2 WAYS PLUS WASHING DISTRIBUTOR</td> <td>1</td> <td>PZ</td> </tr> <tr> <td>VM2172A0</td> <td>PUMP-WITH-CIRCUIT LOCKING PIN</td> <td>6</td> <td>PZ</td> </tr> </tbody> </table>	Code	Description	Qty	UOM	TB3132A0	WHITE-BLUE EPDM TEXTILE BRAID HOSE 6X12	1.400	M	V11220A1	4,2X12 TCB SELF-TAPPING SCREW	3	PZ	VL1019A0	VIBRATION PUMP	1	PZ	VL1047A1	D6 PIPE HOLDER - D8 J.G. TERMINAL	1	PZ	VL1054B0	ONE WASHING SYSTEM INLET DISTRIBUTOR	1	PZ	VL1065A1	1/4 MALE N.O. PRESSURE SWITCH	1	PZ	VL1102A1	DETERGENT LINE FILTER + BARBED VNR 6 MM	1	PZ	VL1128A1	D6 BARBED CHECK VALVE	2	PZ	VL1165A0	BB6-AR6 STRAIGHT FITTING	1	PZ	VL1166A0	BB6-AR6 L FITTING	3	PZ	VL1174C0	D1.2 MM CALIBRATED NOZZLE	1	PZ	VL1185A0	2 WAYS PLUS WASHING DISTRIBUTOR	1	PZ	VM2172A0	PUMP-WITH-CIRCUIT LOCKING PIN	6	PZ	KVL1212A	EUR COMPACT PLUS CLEANING SYSTEM KIT	<table border="1"> <thead> <tr> <th>Code</th> <th>Description</th> <th>Qty</th> <th>UOM</th> </tr> </thead> <tbody> <tr> <td>0H2428A0</td> <td></td> <td>1</td> <td>PZ</td> </tr> <tr> <td>EL1440A0</td> <td>WATER SELF CLEANING VALVE</td> <td>3</td> <td>PZ</td> </tr> <tr> <td>GN1312A0</td> <td>RUBBER CABLE-PASSING DE=26 DI=15 SP=10</td> <td>1</td> <td>PZ</td> </tr> <tr> <td>GN1526A0</td> <td>INT. D.=6.9 TH=1.8 O-RING</td> <td>7</td> <td>PZ</td> </tr> <tr> <td>RC1018A0</td> <td>ZINC PLATED D12 ELASTIC CLAMP</td> <td>3</td> <td>PZ</td> </tr> </tbody> </table>	Code	Description	Qty	UOM	0H2428A0		1	PZ	EL1440A0	WATER SELF CLEANING VALVE	3	PZ	GN1312A0	RUBBER CABLE-PASSING DE=26 DI=15 SP=10	1	PZ	GN1526A0	INT. D.=6.9 TH=1.8 O-RING	7	PZ	RC1018A0	ZINC PLATED D12 ELASTIC CLAMP	3	PZ
			Code	Description	Qty	UOM																																																																																		
TB3132A0	WHITE-BLUE EPDM TEXTILE BRAID HOSE 6X12	1.400	M																																																																																					
V11220A1	4,2X12 TCB SELF-TAPPING SCREW	3	PZ																																																																																					
VL1019A0	VIBRATION PUMP	1	PZ																																																																																					
VL1047A1	D6 PIPE HOLDER - D8 J.G. TERMINAL	1	PZ																																																																																					
VL1054B0	ONE WASHING SYSTEM INLET DISTRIBUTOR	1	PZ																																																																																					
VL1065A1	1/4 MALE N.O. PRESSURE SWITCH	1	PZ																																																																																					
VL1102A1	DETERGENT LINE FILTER + BARBED VNR 6 MM	1	PZ																																																																																					
VL1128A1	D6 BARBED CHECK VALVE	2	PZ																																																																																					
VL1165A0	BB6-AR6 STRAIGHT FITTING	1	PZ																																																																																					
VL1166A0	BB6-AR6 L FITTING	3	PZ																																																																																					
VL1174C0	D1.2 MM CALIBRATED NOZZLE	1	PZ																																																																																					
VL1185A0	2 WAYS PLUS WASHING DISTRIBUTOR	1	PZ																																																																																					
VM2172A0	PUMP-WITH-CIRCUIT LOCKING PIN	6	PZ																																																																																					
Code	Description	Qty	UOM																																																																																					
0H2428A0		1	PZ																																																																																					
EL1440A0	WATER SELF CLEANING VALVE	3	PZ																																																																																					
GN1312A0	RUBBER CABLE-PASSING DE=26 DI=15 SP=10	1	PZ																																																																																					
GN1526A0	INT. D.=6.9 TH=1.8 O-RING	7	PZ																																																																																					
RC1018A0	ZINC PLATED D12 ELASTIC CLAMP	3	PZ																																																																																					

COMPONENT			SPARE PART																																																																																		
Code	Description	Image	Code	Description	Components list																																																																																
VL1019A	VIBRATION PUMP		KVL1212A	EUR COMPACT PLUS CLEANING SYSTEM KIT	<table border="1"> <thead> <tr> <th>Code</th> <th>Description</th> <th>Qty</th> <th>UOM</th> </tr> </thead> <tbody> <tr> <td>RC1019A0</td> <td>D=10 ELASTIC CLAMP</td> <td>14</td> <td>PZ</td> </tr> <tr> <td>RC1130A0</td> <td>130X2,6 CLAM</td> <td>1</td> <td>PZ</td> </tr> <tr> <td>RC1131A0</td> <td>200X2.6 BLACK CLAMP</td> <td>1</td> <td>PZ</td> </tr> <tr> <td>RC1242A0</td> <td>D=10 CLOSED CAP</td> <td>2</td> <td>PZ</td> </tr> <tr> <td>RC1356A0</td> <td>"STRAIGHT THREADED FEMALE END 8X1/4" BS</td> <td>1</td> <td>PZ</td> </tr> <tr> <td>TB2820A0</td> <td>6X10 EPDM PIPE FOR WASHING SYSTEM</td> <td>1.340</td> <td>M</td> </tr> <tr> <td>TB3132A0</td> <td>WHITE-BLUE EPDM TEXTILE BRAID HOSE 6X12</td> <td>1.400</td> <td>M</td> </tr> <tr> <td>VI1220A1</td> <td>4,2X12 TCB SELF-TAPPIN G SCREW</td> <td>3</td> <td>PZ</td> </tr> <tr> <td>VL1019A0</td> <td>VIBRATION PUMP</td> <td>1</td> <td>PZ</td> </tr> <tr> <td>VL1047A1</td> <td>D6 PIPE HOLDER - D8 J.G. TERMINAL</td> <td>1</td> <td>PZ</td> </tr> <tr> <td>VL1054B0</td> <td>ONE WASHING SYS INLET DISTRIBUTOR</td> <td>1</td> <td>PZ</td> </tr> <tr> <td>VL1065A1</td> <td>1/4 MALE N.O. PRESSURE SWITCH</td> <td>1</td> <td>PZ</td> </tr> <tr> <td>VL1102A1</td> <td>DETERGENT LINE FILTER + BARBED VNR 6 MM</td> <td>1</td> <td>PZ</td> </tr> <tr> <td>VL1128A1</td> <td>D6 BARBED CHECK VALVE</td> <td>2</td> <td>PZ</td> </tr> <tr> <td>VL1165A0</td> <td>BB6-AR6 STRAIGHT FITTING</td> <td>1</td> <td>PZ</td> </tr> <tr> <td>VL1166A0</td> <td>BB6-AR6 L FITTING</td> <td>3</td> <td>PZ</td> </tr> <tr> <td>VL1174C0</td> <td>D1.2 MM CALIBRATED NOZZLE</td> <td>1</td> <td>PZ</td> </tr> <tr> <td>VL1185A0</td> <td>2 WAYS PLUS WASHING DISTRIBUTOR</td> <td>1</td> <td>PZ</td> </tr> <tr> <td>VM2172A0</td> <td>PUMP-WITH-CI RCUIT LOCKING PIN</td> <td>6</td> <td>PZ</td> </tr> </tbody> </table>	Code	Description	Qty	UOM	RC1019A0	D=10 ELASTIC CLAMP	14	PZ	RC1130A0	130X2,6 CLAM	1	PZ	RC1131A0	200X2.6 BLACK CLAMP	1	PZ	RC1242A0	D=10 CLOSED CAP	2	PZ	RC1356A0	"STRAIGHT THREADED FEMALE END 8X1/4" BS	1	PZ	TB2820A0	6X10 EPDM PIPE FOR WASHING SYSTEM	1.340	M	TB3132A0	WHITE-BLUE EPDM TEXTILE BRAID HOSE 6X12	1.400	M	VI1220A1	4,2X12 TCB SELF-TAPPIN G SCREW	3	PZ	VL1019A0	VIBRATION PUMP	1	PZ	VL1047A1	D6 PIPE HOLDER - D8 J.G. TERMINAL	1	PZ	VL1054B0	ONE WASHING SYS INLET DISTRIBUTOR	1	PZ	VL1065A1	1/4 MALE N.O. PRESSURE SWITCH	1	PZ	VL1102A1	DETERGENT LINE FILTER + BARBED VNR 6 MM	1	PZ	VL1128A1	D6 BARBED CHECK VALVE	2	PZ	VL1165A0	BB6-AR6 STRAIGHT FITTING	1	PZ	VL1166A0	BB6-AR6 L FITTING	3	PZ	VL1174C0	D1.2 MM CALIBRATED NOZZLE	1	PZ	VL1185A0	2 WAYS PLUS WASHING DISTRIBUTOR	1	PZ	VM2172A0	PUMP-WITH-CI RCUIT LOCKING PIN	6	PZ
Code	Description	Qty	UOM																																																																																		
RC1019A0	D=10 ELASTIC CLAMP	14	PZ																																																																																		
RC1130A0	130X2,6 CLAM	1	PZ																																																																																		
RC1131A0	200X2.6 BLACK CLAMP	1	PZ																																																																																		
RC1242A0	D=10 CLOSED CAP	2	PZ																																																																																		
RC1356A0	"STRAIGHT THREADED FEMALE END 8X1/4" BS	1	PZ																																																																																		
TB2820A0	6X10 EPDM PIPE FOR WASHING SYSTEM	1.340	M																																																																																		
TB3132A0	WHITE-BLUE EPDM TEXTILE BRAID HOSE 6X12	1.400	M																																																																																		
VI1220A1	4,2X12 TCB SELF-TAPPIN G SCREW	3	PZ																																																																																		
VL1019A0	VIBRATION PUMP	1	PZ																																																																																		
VL1047A1	D6 PIPE HOLDER - D8 J.G. TERMINAL	1	PZ																																																																																		
VL1054B0	ONE WASHING SYS INLET DISTRIBUTOR	1	PZ																																																																																		
VL1065A1	1/4 MALE N.O. PRESSURE SWITCH	1	PZ																																																																																		
VL1102A1	DETERGENT LINE FILTER + BARBED VNR 6 MM	1	PZ																																																																																		
VL1128A1	D6 BARBED CHECK VALVE	2	PZ																																																																																		
VL1165A0	BB6-AR6 STRAIGHT FITTING	1	PZ																																																																																		
VL1166A0	BB6-AR6 L FITTING	3	PZ																																																																																		
VL1174C0	D1.2 MM CALIBRATED NOZZLE	1	PZ																																																																																		
VL1185A0	2 WAYS PLUS WASHING DISTRIBUTOR	1	PZ																																																																																		
VM2172A0	PUMP-WITH-CI RCUIT LOCKING PIN	6	PZ																																																																																		

COMPONENT			SPARE PART																																																																																						
Code	Description	Image	Code	Description	Components list																																																																																				
VL1019A	VIBRATION PUMP		KVL1211A	ONE COMPACT AND 0523-EP WASH. SYSTEM KIT	<table border="1"> <thead> <tr> <th>Code</th> <th>Description</th> <th>Qty</th> <th>UOM</th> </tr> </thead> <tbody> <tr> <td>0H2427A0</td> <td></td> <td>1</td> <td>PZ</td> </tr> <tr> <td>EL1440A0</td> <td>WATER SELF CLEANING VALVE</td> <td>1</td> <td>PZ</td> </tr> <tr> <td>GN1526A0</td> <td>INT. D.=6.9 TH=1.8 O-RIN</td> <td>3</td> <td>PZ</td> </tr> <tr> <td>RC1018A0</td> <td>ZINC PLATED D12 ELASTIC CLAMP</td> <td>2</td> <td>PZ</td> </tr> <tr> <td>RC1019A0</td> <td>D=10 ELASTIC CLAMP</td> <td>14</td> <td>PZ</td> </tr> <tr> <td>RC1130A0</td> <td>130X2,6 CLAM</td> <td>1</td> <td>PZ</td> </tr> <tr> <td>RC1242A0</td> <td>D=10 CLOSED CAP</td> <td>2</td> <td>PZ</td> </tr> <tr> <td>TB2820A0</td> <td>6X10 EPDM PIPE FOR WASHING SYSTEM</td> <td>1.290</td> <td>M</td> </tr> <tr> <td>TB3132A0</td> <td>WHITE-BLUE EPDM TEXTILE BRAID HOSE 6X12</td> <td>0.670</td> <td>M</td> </tr> <tr> <td>V11220A1</td> <td>4,2X12 TCB SELF-TAPPIN G SCREW</td> <td>4</td> <td>PZ</td> </tr> <tr> <td>VL1019A0</td> <td>VIBRATION PUMP</td> <td>1</td> <td>PZ</td> </tr> <tr> <td>VL1047A1</td> <td>D6 PIPE HOLDER - D8 J.G. TERMINAL</td> <td>1</td> <td>PZ</td> </tr> <tr> <td>VL1054B0</td> <td>ONE WASHING SYS INLET DISTRIBUTOR</td> <td>1</td> <td>PZ</td> </tr> <tr> <td>VL1102A1</td> <td>DETERGENT LINE FILTER + BARBED VNR 6 MM</td> <td>1</td> <td>PZ</td> </tr> <tr> <td>VL1128A1</td> <td>D6 BARBED CHECK VALVE</td> <td>2</td> <td>PZ</td> </tr> <tr> <td>VL1165A0</td> <td>BB6-AR6 STRAIGHT FITTING</td> <td>1</td> <td>PZ</td> </tr> <tr> <td>VL1166A0</td> <td>BB6-AR6 L FITTING</td> <td>1</td> <td>PZ</td> </tr> <tr> <td>VL1174C0</td> <td>D1.2 MM CALIBRATED NOZZLE</td> <td>1</td> <td>PZ</td> </tr> <tr> <td>VL1191A0</td> <td>ONE WASHING DISTRIBUTOR OUTLETS KIT</td> <td>1</td> <td>PZ</td> </tr> <tr> <td>VM2172A0</td> <td>PUMP-WITH-CI RCUIT LOCKING PIN</td> <td>3</td> <td>PZ</td> </tr> </tbody> </table>	Code	Description	Qty	UOM	0H2427A0		1	PZ	EL1440A0	WATER SELF CLEANING VALVE	1	PZ	GN1526A0	INT. D.=6.9 TH=1.8 O-RIN	3	PZ	RC1018A0	ZINC PLATED D12 ELASTIC CLAMP	2	PZ	RC1019A0	D=10 ELASTIC CLAMP	14	PZ	RC1130A0	130X2,6 CLAM	1	PZ	RC1242A0	D=10 CLOSED CAP	2	PZ	TB2820A0	6X10 EPDM PIPE FOR WASHING SYSTEM	1.290	M	TB3132A0	WHITE-BLUE EPDM TEXTILE BRAID HOSE 6X12	0.670	M	V11220A1	4,2X12 TCB SELF-TAPPIN G SCREW	4	PZ	VL1019A0	VIBRATION PUMP	1	PZ	VL1047A1	D6 PIPE HOLDER - D8 J.G. TERMINAL	1	PZ	VL1054B0	ONE WASHING SYS INLET DISTRIBUTOR	1	PZ	VL1102A1	DETERGENT LINE FILTER + BARBED VNR 6 MM	1	PZ	VL1128A1	D6 BARBED CHECK VALVE	2	PZ	VL1165A0	BB6-AR6 STRAIGHT FITTING	1	PZ	VL1166A0	BB6-AR6 L FITTING	1	PZ	VL1174C0	D1.2 MM CALIBRATED NOZZLE	1	PZ	VL1191A0	ONE WASHING DISTRIBUTOR OUTLETS KIT	1	PZ	VM2172A0	PUMP-WITH-CI RCUIT LOCKING PIN	3	PZ
Code	Description	Qty	UOM																																																																																						
0H2427A0		1	PZ																																																																																						
EL1440A0	WATER SELF CLEANING VALVE	1	PZ																																																																																						
GN1526A0	INT. D.=6.9 TH=1.8 O-RIN	3	PZ																																																																																						
RC1018A0	ZINC PLATED D12 ELASTIC CLAMP	2	PZ																																																																																						
RC1019A0	D=10 ELASTIC CLAMP	14	PZ																																																																																						
RC1130A0	130X2,6 CLAM	1	PZ																																																																																						
RC1242A0	D=10 CLOSED CAP	2	PZ																																																																																						
TB2820A0	6X10 EPDM PIPE FOR WASHING SYSTEM	1.290	M																																																																																						
TB3132A0	WHITE-BLUE EPDM TEXTILE BRAID HOSE 6X12	0.670	M																																																																																						
V11220A1	4,2X12 TCB SELF-TAPPIN G SCREW	4	PZ																																																																																						
VL1019A0	VIBRATION PUMP	1	PZ																																																																																						
VL1047A1	D6 PIPE HOLDER - D8 J.G. TERMINAL	1	PZ																																																																																						
VL1054B0	ONE WASHING SYS INLET DISTRIBUTOR	1	PZ																																																																																						
VL1102A1	DETERGENT LINE FILTER + BARBED VNR 6 MM	1	PZ																																																																																						
VL1128A1	D6 BARBED CHECK VALVE	2	PZ																																																																																						
VL1165A0	BB6-AR6 STRAIGHT FITTING	1	PZ																																																																																						
VL1166A0	BB6-AR6 L FITTING	1	PZ																																																																																						
VL1174C0	D1.2 MM CALIBRATED NOZZLE	1	PZ																																																																																						
VL1191A0	ONE WASHING DISTRIBUTOR OUTLETS KIT	1	PZ																																																																																						
VM2172A0	PUMP-WITH-CI RCUIT LOCKING PIN	3	PZ																																																																																						





COMPONENT			SPARE PART																																																																																						
Code	Description	Image	Code	Description	Components list																																																																																				
VL1019A	VIBRATION PUMP		KVL1208A	US PLUS 2 ROTOR ARMS WASHING SYSTEM KIT	<table border="1"> <thead> <tr> <th>Code</th> <th>Description</th> <th>Qty</th> <th>UOM</th> </tr> </thead> <tbody> <tr> <td>0H2354A0</td> <td>XEVC-XEVL WASHING CIRCUIT PLAT</td> <td>1</td> <td>PZ</td> </tr> <tr> <td>0H2411A0</td> <td></td> <td>1</td> <td>PZ</td> </tr> <tr> <td>EL1450A0</td> <td>US SELF-CLEANIN G WATER SOLENOID</td> <td>4</td> <td>PZ</td> </tr> <tr> <td>GN1526A0</td> <td>INT. D.=6.9 TH=1.8 O-RIN</td> <td>9</td> <td>PZ</td> </tr> <tr> <td>RC1018A0</td> <td>ZINC PLATED D12 ELASTIC CLAMP</td> <td>4</td> <td>PZ</td> </tr> <tr> <td>RC1019A0</td> <td>D=10 ELASTIC CLAMP</td> <td>16</td> <td>PZ</td> </tr> <tr> <td>RC1130A0</td> <td>130X2,6 CLAM</td> <td>1</td> <td>PZ</td> </tr> <tr> <td>RC1131A0</td> <td>200X2.6 BLACK CLAMP</td> <td>3</td> <td>PZ</td> </tr> <tr> <td>RC1242A0</td> <td>D=10 CLOSED CAP</td> <td>2</td> <td>PZ</td> </tr> <tr> <td>RC1356A0</td> <td>*STRAIGHT THREADED FEMALE END 8X1/4" BS</td> <td>1</td> <td>PZ</td> </tr> <tr> <td>TB2820A0</td> <td>6X10 EPDM PIPE FOR WASHING SYSTEM</td> <td>2.890</td> <td>M</td> </tr> <tr> <td>TB3132A0</td> <td>WHITE-BLUE EPDM TEXTILE BRAID HOSE 6X12</td> <td>1.600</td> <td>M</td> </tr> <tr> <td>VI1220A1</td> <td>4,2X12 TCB SELF-TAPPIN G SCREW</td> <td>3</td> <td>PZ</td> </tr> <tr> <td>VL1019A0</td> <td>VIBRATION PUMP</td> <td>1</td> <td>PZ</td> </tr> <tr> <td>VL1047A1</td> <td>D6 PIPE HOLDER - D8 J.G. TERMINAL</td> <td>1</td> <td>PZ</td> </tr> <tr> <td>VL1065A1</td> <td>1/4 MALE N.O. PRESSURE SWITCH</td> <td>1</td> <td>PZ</td> </tr> <tr> <td>VL1102A1</td> <td>DETERGENT LINE FILTER + BARBED VNR 6 MM</td> <td>1</td> <td>PZ</td> </tr> <tr> <td>VL1128A1</td> <td>D6 BARBED CHECK VALVE</td> <td>2</td> <td>PZ</td> </tr> <tr> <td>VL1141A1</td> <td>STRAIGHT CONNECT BB6-BB6</td> <td>1</td> <td>PZ</td> </tr> <tr> <td>VL1165A0</td> <td>BB6-AR6 STRAIGHT FITTING</td> <td>1</td> <td>PZ</td> </tr> </tbody> </table>	Code	Description	Qty	UOM	0H2354A0	XEVC-XEVL WASHING CIRCUIT PLAT	1	PZ	0H2411A0		1	PZ	EL1450A0	US SELF-CLEANIN G WATER SOLENOID	4	PZ	GN1526A0	INT. D.=6.9 TH=1.8 O-RIN	9	PZ	RC1018A0	ZINC PLATED D12 ELASTIC CLAMP	4	PZ	RC1019A0	D=10 ELASTIC CLAMP	16	PZ	RC1130A0	130X2,6 CLAM	1	PZ	RC1131A0	200X2.6 BLACK CLAMP	3	PZ	RC1242A0	D=10 CLOSED CAP	2	PZ	RC1356A0	*STRAIGHT THREADED FEMALE END 8X1/4" BS	1	PZ	TB2820A0	6X10 EPDM PIPE FOR WASHING SYSTEM	2.890	M	TB3132A0	WHITE-BLUE EPDM TEXTILE BRAID HOSE 6X12	1.600	M	VI1220A1	4,2X12 TCB SELF-TAPPIN G SCREW	3	PZ	VL1019A0	VIBRATION PUMP	1	PZ	VL1047A1	D6 PIPE HOLDER - D8 J.G. TERMINAL	1	PZ	VL1065A1	1/4 MALE N.O. PRESSURE SWITCH	1	PZ	VL1102A1	DETERGENT LINE FILTER + BARBED VNR 6 MM	1	PZ	VL1128A1	D6 BARBED CHECK VALVE	2	PZ	VL1141A1	STRAIGHT CONNECT BB6-BB6	1	PZ	VL1165A0	BB6-AR6 STRAIGHT FITTING	1	PZ
Code	Description	Qty	UOM																																																																																						
0H2354A0	XEVC-XEVL WASHING CIRCUIT PLAT	1	PZ																																																																																						
0H2411A0		1	PZ																																																																																						
EL1450A0	US SELF-CLEANIN G WATER SOLENOID	4	PZ																																																																																						
GN1526A0	INT. D.=6.9 TH=1.8 O-RIN	9	PZ																																																																																						
RC1018A0	ZINC PLATED D12 ELASTIC CLAMP	4	PZ																																																																																						
RC1019A0	D=10 ELASTIC CLAMP	16	PZ																																																																																						
RC1130A0	130X2,6 CLAM	1	PZ																																																																																						
RC1131A0	200X2.6 BLACK CLAMP	3	PZ																																																																																						
RC1242A0	D=10 CLOSED CAP	2	PZ																																																																																						
RC1356A0	*STRAIGHT THREADED FEMALE END 8X1/4" BS	1	PZ																																																																																						
TB2820A0	6X10 EPDM PIPE FOR WASHING SYSTEM	2.890	M																																																																																						
TB3132A0	WHITE-BLUE EPDM TEXTILE BRAID HOSE 6X12	1.600	M																																																																																						
VI1220A1	4,2X12 TCB SELF-TAPPIN G SCREW	3	PZ																																																																																						
VL1019A0	VIBRATION PUMP	1	PZ																																																																																						
VL1047A1	D6 PIPE HOLDER - D8 J.G. TERMINAL	1	PZ																																																																																						
VL1065A1	1/4 MALE N.O. PRESSURE SWITCH	1	PZ																																																																																						
VL1102A1	DETERGENT LINE FILTER + BARBED VNR 6 MM	1	PZ																																																																																						
VL1128A1	D6 BARBED CHECK VALVE	2	PZ																																																																																						
VL1141A1	STRAIGHT CONNECT BB6-BB6	1	PZ																																																																																						
VL1165A0	BB6-AR6 STRAIGHT FITTING	1	PZ																																																																																						





COMPONENT			SPARE PART																																																							
Code	Description	Image	Code	Description	Components list																																																					
VL1019A	VIBRATION PUMP		KVL1208A	US PLUS 2 ROTOR ARMS WASHING SYSTEM KIT	<table border="1"> <thead> <tr> <th>Code</th> <th>Description</th> <th>Qty</th> <th>UOM</th> </tr> </thead> <tbody> <tr> <td>VL1166A0</td> <td>BB6-AR6 L FITTING</td> <td>4</td> <td>PZ</td> </tr> <tr> <td>VL1174C0</td> <td>D1.2 MM CALIBRATED NOZZLE</td> <td>1</td> <td>PZ</td> </tr> <tr> <td>VL1186A0</td> <td>3 WAYS PLUS WASHING DISTRIBUTOR</td> <td>1</td> <td>PZ</td> </tr> <tr> <td>VL1190A0</td> <td>PLUS WASHING SYSTEM INLET DISTRIBUTOR</td> <td>1</td> <td>PZ</td> </tr> <tr> <td>VM1605A0</td> <td>CLIP TWIST LOCK DIAM. 10,2-12,7 MM</td> <td>6</td> <td>PZ</td> </tr> <tr> <td>VM2172A0</td> <td>PUMP-WITH-CI RCUIT LOCKING PIN</td> <td>9</td> <td>PZ</td> </tr> </tbody> </table>	Code	Description	Qty	UOM	VL1166A0	BB6-AR6 L FITTING	4	PZ	VL1174C0	D1.2 MM CALIBRATED NOZZLE	1	PZ	VL1186A0	3 WAYS PLUS WASHING DISTRIBUTOR	1	PZ	VL1190A0	PLUS WASHING SYSTEM INLET DISTRIBUTOR	1	PZ	VM1605A0	CLIP TWIST LOCK DIAM. 10,2-12,7 MM	6	PZ	VM2172A0	PUMP-WITH-CI RCUIT LOCKING PIN	9	PZ																									
			Code	Description	Qty	UOM																																																				
VL1166A0	BB6-AR6 L FITTING	4	PZ																																																							
VL1174C0	D1.2 MM CALIBRATED NOZZLE	1	PZ																																																							
VL1186A0	3 WAYS PLUS WASHING DISTRIBUTOR	1	PZ																																																							
VL1190A0	PLUS WASHING SYSTEM INLET DISTRIBUTOR	1	PZ																																																							
VM1605A0	CLIP TWIST LOCK DIAM. 10,2-12,7 MM	6	PZ																																																							
VM2172A0	PUMP-WITH-CI RCUIT LOCKING PIN	9	PZ																																																							
KVL1207A	US PLUS 1 ROTOR ARM WASHING SYSTEM KIT	<table border="1"> <thead> <tr> <th>Code</th> <th>Description</th> <th>Qty</th> <th>UOM</th> </tr> </thead> <tbody> <tr> <td>0H2354A0</td> <td>XEVC-XEVL WASHING CIRCUIT PLAT</td> <td>1</td> <td>PZ</td> </tr> <tr> <td>0H2411A0</td> <td></td> <td>1</td> <td>PZ</td> </tr> <tr> <td>EL1450A0</td> <td>US SELF-CLEANIN G WATER SOLENOID</td> <td>3</td> <td>PZ</td> </tr> <tr> <td>GN1526A0</td> <td>INT. D.=6.9 TH=1.8 O-RIN</td> <td>7</td> <td>PZ</td> </tr> <tr> <td>RC1018A0</td> <td>ZINC PLATED D12 ELASTIC CLAMP</td> <td>3</td> <td>PZ</td> </tr> <tr> <td>RC1019A0</td> <td>D=10 ELASTIC CLAMP</td> <td>14</td> <td>PZ</td> </tr> <tr> <td>RC1130A0</td> <td>130X2,6 CLAM</td> <td>1</td> <td>PZ</td> </tr> <tr> <td>RC1131A0</td> <td>200X2,6 BLACK CLAMP</td> <td>2</td> <td>PZ</td> </tr> <tr> <td>RC1242A0</td> <td>D=10 CLOSED CAP</td> <td>2</td> <td>PZ</td> </tr> <tr> <td>RC1356A0</td> <td>"STRAIGHT THREADED FEMALE END 8X1/4" BS</td> <td>1</td> <td>PZ</td> </tr> <tr> <td>TB2820A0</td> <td>6X10 EPDM PIPE FOR WASHING SYSTEM</td> <td>1.460</td> <td>M</td> </tr> <tr> <td>TB3132A0</td> <td>WHITE-BLUE EPDM TEXTILE BRAID HOSE 6X12</td> <td>0.770</td> <td>M</td> </tr> <tr> <td>VI1220A1</td> <td>4,2X12 TCB SELF-TAPPIN G SCREW</td> <td>3</td> <td>PZ</td> </tr> </tbody> </table>	Code	Description	Qty	UOM	0H2354A0	XEVC-XEVL WASHING CIRCUIT PLAT	1	PZ	0H2411A0		1	PZ	EL1450A0	US SELF-CLEANIN G WATER SOLENOID	3	PZ	GN1526A0	INT. D.=6.9 TH=1.8 O-RIN	7	PZ	RC1018A0	ZINC PLATED D12 ELASTIC CLAMP	3	PZ	RC1019A0	D=10 ELASTIC CLAMP	14	PZ	RC1130A0	130X2,6 CLAM	1	PZ	RC1131A0	200X2,6 BLACK CLAMP	2	PZ	RC1242A0	D=10 CLOSED CAP	2	PZ	RC1356A0	"STRAIGHT THREADED FEMALE END 8X1/4" BS	1	PZ	TB2820A0	6X10 EPDM PIPE FOR WASHING SYSTEM	1.460	M	TB3132A0	WHITE-BLUE EPDM TEXTILE BRAID HOSE 6X12	0.770	M	VI1220A1	4,2X12 TCB SELF-TAPPIN G SCREW	3	PZ
Code	Description	Qty	UOM																																																							
0H2354A0	XEVC-XEVL WASHING CIRCUIT PLAT	1	PZ																																																							
0H2411A0		1	PZ																																																							
EL1450A0	US SELF-CLEANIN G WATER SOLENOID	3	PZ																																																							
GN1526A0	INT. D.=6.9 TH=1.8 O-RIN	7	PZ																																																							
RC1018A0	ZINC PLATED D12 ELASTIC CLAMP	3	PZ																																																							
RC1019A0	D=10 ELASTIC CLAMP	14	PZ																																																							
RC1130A0	130X2,6 CLAM	1	PZ																																																							
RC1131A0	200X2,6 BLACK CLAMP	2	PZ																																																							
RC1242A0	D=10 CLOSED CAP	2	PZ																																																							
RC1356A0	"STRAIGHT THREADED FEMALE END 8X1/4" BS	1	PZ																																																							
TB2820A0	6X10 EPDM PIPE FOR WASHING SYSTEM	1.460	M																																																							
TB3132A0	WHITE-BLUE EPDM TEXTILE BRAID HOSE 6X12	0.770	M																																																							
VI1220A1	4,2X12 TCB SELF-TAPPIN G SCREW	3	PZ																																																							

COMPONENT			SPARE PART																																																																																									
Code	Description	Image	Code	Description	Components list																																																																																							
VL1019A	VIBRATION PUMP		KVL1207A	US PLUS 1 ROTOR ARM WASHING SYSTEM KIT	<table border="1"> <thead> <tr> <th>Code</th> <th>Description</th> <th>Qty</th> <th>UOM</th> </tr> </thead> <tbody> <tr> <td>VL1019A0</td> <td>VIBRATION PUMP</td> <td>1</td> <td>PZ</td> </tr> <tr> <td>VL1047A1</td> <td>D6 PIPE HOLDER - D8 J.G. TERMINAL</td> <td>1</td> <td>PZ</td> </tr> <tr> <td>VL1065A1</td> <td>1/4 MALE N.O. PRESSURE SWITCH</td> <td>1</td> <td>PZ</td> </tr> <tr> <td>VL1102A1</td> <td>DETERGENT LINE FILTER + BARBED VNR 6 MM</td> <td>1</td> <td>PZ</td> </tr> <tr> <td>VL1128A1</td> <td>D6 BARBED CHECK VALVE</td> <td>2</td> <td>PZ</td> </tr> <tr> <td>VL1165A0</td> <td>BB6-AR6 STRAIGHT FITTING</td> <td>1</td> <td>PZ</td> </tr> <tr> <td>VL1166A0</td> <td>BB6-AR6 L FITTING</td> <td>3</td> <td>PZ</td> </tr> <tr> <td>VL1174C0</td> <td>D1.2 MM CALIBRATED NOZZLE</td> <td>1</td> <td>PZ</td> </tr> <tr> <td>VL1185A0</td> <td>2 WAYS PLUS WASHING DISTRIBUTOR</td> <td>1</td> <td>PZ</td> </tr> <tr> <td>VL1190A0</td> <td>PLUS WASHING SYSTEM INLET DISTRIBUTOR</td> <td>1</td> <td>PZ</td> </tr> <tr> <td>VM1605A0</td> <td>CLIP TWIST LOCK DIAM. 10.2-12.7 MM</td> <td>6</td> <td>PZ</td> </tr> <tr> <td>VM2172A0</td> <td>PUMP-WITH-CI RCUIT LOCKING PIN</td> <td>6</td> <td>PZ</td> </tr> </tbody> </table>	Code	Description	Qty	UOM	VL1019A0	VIBRATION PUMP	1	PZ	VL1047A1	D6 PIPE HOLDER - D8 J.G. TERMINAL	1	PZ	VL1065A1	1/4 MALE N.O. PRESSURE SWITCH	1	PZ	VL1102A1	DETERGENT LINE FILTER + BARBED VNR 6 MM	1	PZ	VL1128A1	D6 BARBED CHECK VALVE	2	PZ	VL1165A0	BB6-AR6 STRAIGHT FITTING	1	PZ	VL1166A0	BB6-AR6 L FITTING	3	PZ	VL1174C0	D1.2 MM CALIBRATED NOZZLE	1	PZ	VL1185A0	2 WAYS PLUS WASHING DISTRIBUTOR	1	PZ	VL1190A0	PLUS WASHING SYSTEM INLET DISTRIBUTOR	1	PZ	VM1605A0	CLIP TWIST LOCK DIAM. 10.2-12.7 MM	6	PZ	VM2172A0	PUMP-WITH-CI RCUIT LOCKING PIN	6	PZ	KVL1198A	MM EU HOOD CLEANING SYSTEM KIT	<table border="1"> <thead> <tr> <th>Code</th> <th>Description</th> <th>Qty</th> <th>UOM</th> </tr> </thead> <tbody> <tr> <td>0H2213A1</td> <td>HOOD WATER CIRCUIT PLAT</td> <td>1</td> <td>PZ</td> </tr> <tr> <td>EL1440A0</td> <td>WATER SELF CLEANING VALVE</td> <td>2</td> <td>PZ</td> </tr> <tr> <td>GN1526A0</td> <td>INT. D.=6.9 TH=1.8 O-RIN</td> <td>5</td> <td>PZ</td> </tr> <tr> <td>RC1018A0</td> <td>ZINC PLATED D12 ELASTIC CLAMP</td> <td>6</td> <td>PZ</td> </tr> <tr> <td>RC1019A0</td> <td>D=10 ELASTIC CLAMP</td> <td>16</td> <td>PZ</td> </tr> <tr> <td>RC1131A0</td> <td>200X2.6 BLACK CLAMP</td> <td>1</td> <td>PZ</td> </tr> <tr> <td>RC1242A0</td> <td>D=10 CLOSED CAP</td> <td>2</td> <td>PZ</td> </tr> </tbody> </table>	Code	Description	Qty	UOM	0H2213A1	HOOD WATER CIRCUIT PLAT	1	PZ	EL1440A0	WATER SELF CLEANING VALVE	2	PZ	GN1526A0	INT. D.=6.9 TH=1.8 O-RIN	5	PZ	RC1018A0	ZINC PLATED D12 ELASTIC CLAMP	6	PZ	RC1019A0	D=10 ELASTIC CLAMP	16	PZ	RC1131A0	200X2.6 BLACK CLAMP	1	PZ	RC1242A0	D=10 CLOSED CAP	2	PZ
					Code	Description	Qty	UOM																																																																																				
VL1019A0	VIBRATION PUMP	1			PZ																																																																																							
VL1047A1	D6 PIPE HOLDER - D8 J.G. TERMINAL	1			PZ																																																																																							
VL1065A1	1/4 MALE N.O. PRESSURE SWITCH	1			PZ																																																																																							
VL1102A1	DETERGENT LINE FILTER + BARBED VNR 6 MM	1			PZ																																																																																							
VL1128A1	D6 BARBED CHECK VALVE	2			PZ																																																																																							
VL1165A0	BB6-AR6 STRAIGHT FITTING	1			PZ																																																																																							
VL1166A0	BB6-AR6 L FITTING	3			PZ																																																																																							
VL1174C0	D1.2 MM CALIBRATED NOZZLE	1			PZ																																																																																							
VL1185A0	2 WAYS PLUS WASHING DISTRIBUTOR	1			PZ																																																																																							
VL1190A0	PLUS WASHING SYSTEM INLET DISTRIBUTOR	1			PZ																																																																																							
VM1605A0	CLIP TWIST LOCK DIAM. 10.2-12.7 MM	6			PZ																																																																																							
VM2172A0	PUMP-WITH-CI RCUIT LOCKING PIN	6			PZ																																																																																							
Code	Description	Qty			UOM																																																																																							
0H2213A1	HOOD WATER CIRCUIT PLAT	1			PZ																																																																																							
EL1440A0	WATER SELF CLEANING VALVE	2			PZ																																																																																							
GN1526A0	INT. D.=6.9 TH=1.8 O-RIN	5	PZ																																																																																									
RC1018A0	ZINC PLATED D12 ELASTIC CLAMP	6	PZ																																																																																									
RC1019A0	D=10 ELASTIC CLAMP	16	PZ																																																																																									
RC1131A0	200X2.6 BLACK CLAMP	1	PZ																																																																																									
RC1242A0	D=10 CLOSED CAP	2	PZ																																																																																									

COMPONENT			SPARE PART																																																																																	
Code	Description	Image	Code	Description	Components list																																																																															
VL1019A	VIBRATION PUMP		KVL1198A	MM EU HOOD CLEANING SYSTEM KIT	<table border="1"> <thead> <tr> <th>Code</th> <th>Description</th> <th>Qty</th> <th>UOM</th> </tr> </thead> <tbody> <tr> <td>TB2820A0</td> <td>6X10 EPDM PIPE FOR WASHING SYSTEM</td> <td>2.240</td> <td>M</td> </tr> <tr> <td>TB3132A0</td> <td>WHITE-BLUE EPDM TEXTILE BRAID HOSE 6X12</td> <td>0.440</td> <td>M</td> </tr> <tr> <td>VI1220A1</td> <td>4,2X12 TCB SELF-TAPPIN G SCREW</td> <td>3</td> <td>PZ</td> </tr> <tr> <td>VL1019A0</td> <td>VIBRATION PUMP</td> <td>1</td> <td>PZ</td> </tr> <tr> <td>VL1047A1</td> <td>D6 PIPE HOLDER - D8 J.G. TERMINAL</td> <td>2</td> <td>PZ</td> </tr> <tr> <td>VL1054B0</td> <td>ONE WASHING SYS INLET DISTRIBUTOR</td> <td>1</td> <td>PZ</td> </tr> <tr> <td>VL1102A1</td> <td>DETERGENT LINE FILTER + BARBED VNR 6 MM</td> <td>1</td> <td>PZ</td> </tr> <tr> <td>VL1127A1</td> <td>6MM BARBED T-SHAPED FITTING</td> <td>1</td> <td>PZ</td> </tr> <tr> <td>VL1128A1</td> <td>D6 BARBED CHECK VALVE</td> <td>2</td> <td>PZ</td> </tr> <tr> <td>VL1165A0</td> <td>BB6-AR6 STRAIGHT FITTING</td> <td>2</td> <td>PZ</td> </tr> <tr> <td>VL1166A0</td> <td>BB6-AR6 L FITTING</td> <td>2</td> <td>PZ</td> </tr> <tr> <td>VL1174C0</td> <td>D1.2 MM CALIBRATED NOZZLE</td> <td>1</td> <td>PZ</td> </tr> <tr> <td>VL1191A0</td> <td>ONE WASHING DISTRIBUTOR OUTLETS KIT</td> <td>1</td> <td>PZ</td> </tr> <tr> <td>VM1605A0</td> <td>CLIP TWIST LOCK DIAM. 10,2-12,7 MM</td> <td>4</td> <td>PZ</td> </tr> <tr> <td>VM2172A0</td> <td>PUMP-WITH-CI RCUIT LOCKING PIN</td> <td>5</td> <td>PZ</td> </tr> </tbody> </table>	Code	Description	Qty	UOM	TB2820A0	6X10 EPDM PIPE FOR WASHING SYSTEM	2.240	M	TB3132A0	WHITE-BLUE EPDM TEXTILE BRAID HOSE 6X12	0.440	M	VI1220A1	4,2X12 TCB SELF-TAPPIN G SCREW	3	PZ	VL1019A0	VIBRATION PUMP	1	PZ	VL1047A1	D6 PIPE HOLDER - D8 J.G. TERMINAL	2	PZ	VL1054B0	ONE WASHING SYS INLET DISTRIBUTOR	1	PZ	VL1102A1	DETERGENT LINE FILTER + BARBED VNR 6 MM	1	PZ	VL1127A1	6MM BARBED T-SHAPED FITTING	1	PZ	VL1128A1	D6 BARBED CHECK VALVE	2	PZ	VL1165A0	BB6-AR6 STRAIGHT FITTING	2	PZ	VL1166A0	BB6-AR6 L FITTING	2	PZ	VL1174C0	D1.2 MM CALIBRATED NOZZLE	1	PZ	VL1191A0	ONE WASHING DISTRIBUTOR OUTLETS KIT	1	PZ	VM1605A0	CLIP TWIST LOCK DIAM. 10,2-12,7 MM	4	PZ	VM2172A0	PUMP-WITH-CI RCUIT LOCKING PIN	5	PZ	KVL1187A	3 ROTOR ARMS PLUS EU CLEANING SYSTEM KIT	<table border="1"> <thead> <tr> <th>Code</th> <th>Description</th> <th>Qty</th> <th>UOM</th> </tr> </thead> <tbody> <tr> <td>0H2143A0</td> <td>LAMIERA BLOCCA VNR VL1128</td> <td>3</td> <td>PZ</td> </tr> <tr> <td>0H2168A0</td> <td></td> <td>1</td> <td>PZ</td> </tr> </tbody> </table>	Code	Description	Qty	UOM	0H2143A0	LAMIERA BLOCCA VNR VL1128	3	PZ	0H2168A0		1	PZ
					Code	Description	Qty	UOM																																																																												
TB2820A0	6X10 EPDM PIPE FOR WASHING SYSTEM	2.240			M																																																																															
TB3132A0	WHITE-BLUE EPDM TEXTILE BRAID HOSE 6X12	0.440			M																																																																															
VI1220A1	4,2X12 TCB SELF-TAPPIN G SCREW	3			PZ																																																																															
VL1019A0	VIBRATION PUMP	1			PZ																																																																															
VL1047A1	D6 PIPE HOLDER - D8 J.G. TERMINAL	2			PZ																																																																															
VL1054B0	ONE WASHING SYS INLET DISTRIBUTOR	1			PZ																																																																															
VL1102A1	DETERGENT LINE FILTER + BARBED VNR 6 MM	1			PZ																																																																															
VL1127A1	6MM BARBED T-SHAPED FITTING	1			PZ																																																																															
VL1128A1	D6 BARBED CHECK VALVE	2			PZ																																																																															
VL1165A0	BB6-AR6 STRAIGHT FITTING	2			PZ																																																																															
VL1166A0	BB6-AR6 L FITTING	2			PZ																																																																															
VL1174C0	D1.2 MM CALIBRATED NOZZLE	1			PZ																																																																															
VL1191A0	ONE WASHING DISTRIBUTOR OUTLETS KIT	1			PZ																																																																															
VM1605A0	CLIP TWIST LOCK DIAM. 10,2-12,7 MM	4			PZ																																																																															
VM2172A0	PUMP-WITH-CI RCUIT LOCKING PIN	5			PZ																																																																															
Code	Description	Qty	UOM																																																																																	
0H2143A0	LAMIERA BLOCCA VNR VL1128	3	PZ																																																																																	
0H2168A0		1	PZ																																																																																	

COMPONENT			SPARE PART																																																																																		
Code	Description	Image	Code	Description	Components list																																																																																
VL1019A	VIBRATION PUMP		KVL1187A	3 ROTOR ARMS PLUS EU CLEANING SYSTEM KIT	<table border="1"> <thead> <tr> <th>Code</th> <th>Description</th> <th>Qty</th> <th>UOM</th> </tr> </thead> <tbody> <tr> <td>0H2354A0</td> <td>XEVC-XEVL WASHING CIRCUIT PLAT</td> <td>1</td> <td>PZ</td> </tr> <tr> <td>EL1120A0</td> <td>D8-D6 FEMALE STRAIGHT INTERM. CONNECTION</td> <td>1</td> <td>PZ</td> </tr> <tr> <td>EL1220A0</td> <td>JG STRAIGHT CONNECTION Ø8F-Ø8F</td> <td>2</td> <td>PZ</td> </tr> <tr> <td>EL1440A0</td> <td>WATER SELF CLEANING VALVE</td> <td>4</td> <td>PZ</td> </tr> <tr> <td>GN1526A0</td> <td>INT. D.=6.9 TH=1.8 O-RIN</td> <td>9</td> <td>PZ</td> </tr> <tr> <td>RC1018A0</td> <td>ZINC PLATED D12 ELASTIC CLAMP</td> <td>10</td> <td>PZ</td> </tr> <tr> <td>RC1019A0</td> <td>D=10 ELASTIC CLAMP</td> <td>22</td> <td>PZ</td> </tr> <tr> <td>RC1130A0</td> <td>130X2,6 CLAM</td> <td>4</td> <td>PZ</td> </tr> <tr> <td>RC1131A0</td> <td>200X2.6 BLACK CLAMP</td> <td>3</td> <td>PZ</td> </tr> <tr> <td>RC1242A0</td> <td>D=10 CLOSED CAP</td> <td>2</td> <td>PZ</td> </tr> <tr> <td>RC1310A0</td> <td>140X4 CLAMP WITH CLIP</td> <td>1</td> <td>PZ</td> </tr> <tr> <td>RC1356A0</td> <td>"STRAIGHT THREADED FEMALE END 8X1/4" BS</td> <td>1</td> <td>PZ</td> </tr> <tr> <td>TB2820A0</td> <td>6X10 EPDM PIPE FOR WASHING SYSTEM</td> <td>1.510</td> <td>M</td> </tr> <tr> <td>TB3132A0</td> <td>WHITE-BLUE EPDM TEXTILE BRAID HOSE 6X12</td> <td>1.210</td> <td>M</td> </tr> <tr> <td>VI1220A1</td> <td>4,2X12 TCB SELF-TAPPIN G SCREW</td> <td>3</td> <td>PZ</td> </tr> <tr> <td>VL1019A0</td> <td>VIBRATION PUMP</td> <td>1</td> <td>PZ</td> </tr> <tr> <td>VL1046A1</td> <td>D6 PIPE HOLDER - D6 J.G. TERMINAL</td> <td>3</td> <td>PZ</td> </tr> <tr> <td>VL1047A1</td> <td>D6 PIPE HOLDER - D8 J.G. TERMINAL</td> <td>1</td> <td>PZ</td> </tr> <tr> <td>VL1064A0</td> <td>WASHING SYSTEM OUTLETS DISTRIBUTOR</td> <td>1</td> <td>PZ</td> </tr> </tbody> </table>	Code	Description	Qty	UOM	0H2354A0	XEVC-XEVL WASHING CIRCUIT PLAT	1	PZ	EL1120A0	D8-D6 FEMALE STRAIGHT INTERM. CONNECTION	1	PZ	EL1220A0	JG STRAIGHT CONNECTION Ø8F-Ø8F	2	PZ	EL1440A0	WATER SELF CLEANING VALVE	4	PZ	GN1526A0	INT. D.=6.9 TH=1.8 O-RIN	9	PZ	RC1018A0	ZINC PLATED D12 ELASTIC CLAMP	10	PZ	RC1019A0	D=10 ELASTIC CLAMP	22	PZ	RC1130A0	130X2,6 CLAM	4	PZ	RC1131A0	200X2.6 BLACK CLAMP	3	PZ	RC1242A0	D=10 CLOSED CAP	2	PZ	RC1310A0	140X4 CLAMP WITH CLIP	1	PZ	RC1356A0	"STRAIGHT THREADED FEMALE END 8X1/4" BS	1	PZ	TB2820A0	6X10 EPDM PIPE FOR WASHING SYSTEM	1.510	M	TB3132A0	WHITE-BLUE EPDM TEXTILE BRAID HOSE 6X12	1.210	M	VI1220A1	4,2X12 TCB SELF-TAPPIN G SCREW	3	PZ	VL1019A0	VIBRATION PUMP	1	PZ	VL1046A1	D6 PIPE HOLDER - D6 J.G. TERMINAL	3	PZ	VL1047A1	D6 PIPE HOLDER - D8 J.G. TERMINAL	1	PZ	VL1064A0	WASHING SYSTEM OUTLETS DISTRIBUTOR	1	PZ
Code	Description	Qty	UOM																																																																																		
0H2354A0	XEVC-XEVL WASHING CIRCUIT PLAT	1	PZ																																																																																		
EL1120A0	D8-D6 FEMALE STRAIGHT INTERM. CONNECTION	1	PZ																																																																																		
EL1220A0	JG STRAIGHT CONNECTION Ø8F-Ø8F	2	PZ																																																																																		
EL1440A0	WATER SELF CLEANING VALVE	4	PZ																																																																																		
GN1526A0	INT. D.=6.9 TH=1.8 O-RIN	9	PZ																																																																																		
RC1018A0	ZINC PLATED D12 ELASTIC CLAMP	10	PZ																																																																																		
RC1019A0	D=10 ELASTIC CLAMP	22	PZ																																																																																		
RC1130A0	130X2,6 CLAM	4	PZ																																																																																		
RC1131A0	200X2.6 BLACK CLAMP	3	PZ																																																																																		
RC1242A0	D=10 CLOSED CAP	2	PZ																																																																																		
RC1310A0	140X4 CLAMP WITH CLIP	1	PZ																																																																																		
RC1356A0	"STRAIGHT THREADED FEMALE END 8X1/4" BS	1	PZ																																																																																		
TB2820A0	6X10 EPDM PIPE FOR WASHING SYSTEM	1.510	M																																																																																		
TB3132A0	WHITE-BLUE EPDM TEXTILE BRAID HOSE 6X12	1.210	M																																																																																		
VI1220A1	4,2X12 TCB SELF-TAPPIN G SCREW	3	PZ																																																																																		
VL1019A0	VIBRATION PUMP	1	PZ																																																																																		
VL1046A1	D6 PIPE HOLDER - D6 J.G. TERMINAL	3	PZ																																																																																		
VL1047A1	D6 PIPE HOLDER - D8 J.G. TERMINAL	1	PZ																																																																																		
VL1064A0	WASHING SYSTEM OUTLETS DISTRIBUTOR	1	PZ																																																																																		

COMPONENT			SPARE PART																																																																														
Code	Description	Image	Code	Description	Components list																																																																												
VL1019A	VIBRATION PUMP		KVL1187A	3 ROTOR ARMS PLUS EU CLEANING SYSTEM KIT	<table border="1"> <thead> <tr> <th>Code</th> <th>Description</th> <th>Qty</th> <th>UOM</th> </tr> </thead> <tbody> <tr> <td>VL1065A1</td> <td>1/4 MALE N.O. PRESSURE SWITCH</td> <td>1</td> <td>PZ</td> </tr> <tr> <td>VL1067A0</td> <td>WASHING SYSTEM INLETS DISTRIBUTOR</td> <td>1</td> <td>PZ</td> </tr> <tr> <td>VL1092A0</td> <td>WASHING SYSTEM OUTLET DOUBLE DISTRIBUTOR</td> <td>1</td> <td>PZ</td> </tr> <tr> <td>VL1102A1</td> <td>DETERGENT LINE FILTER + BARBED VNR 6 MM</td> <td>1</td> <td>PZ</td> </tr> <tr> <td>VL1127A1</td> <td>6MM BARBED T-SHAPED FITTING</td> <td>2</td> <td>PZ</td> </tr> <tr> <td>VL1128A0</td> <td>D6 BARBED CHECK VALVE</td> <td>3</td> <td>PZ</td> </tr> <tr> <td>VL1128A1</td> <td>D6 BARBED CHECK VALVE</td> <td>3</td> <td>PZ</td> </tr> <tr> <td>VL1165A0</td> <td>BB6-AR6 STRAIGHT FITTING</td> <td>4</td> <td>PZ</td> </tr> <tr> <td>VL1166A0</td> <td>BB6-AR6 L FITTING</td> <td>4</td> <td>PZ</td> </tr> <tr> <td>VL1167A0</td> <td></td> <td>1</td> <td>PZ</td> </tr> <tr> <td>VL1167A1</td> <td></td> <td>1</td> <td>PZ</td> </tr> <tr> <td>VL1167A2</td> <td>GN21 3 ROTOR ARMS B-B FLOW RESTRICTOR</td> <td>1</td> <td>PZ</td> </tr> <tr> <td>VL1174C0</td> <td>D1.2 MM CALIBRATED NOZZLE</td> <td>1</td> <td>PZ</td> </tr> <tr> <td>VL1185A0</td> <td>2 WAYS PLUS WASHING DISTRIBUTOR</td> <td>1</td> <td>PZ</td> </tr> <tr> <td>VL1186A0</td> <td>3 WAYS PLUS WASHING DISTRIBUTOR</td> <td>1</td> <td>PZ</td> </tr> <tr> <td>VL1190A0</td> <td>PLUS WASHING SYSTEM INLET DISTRIBUTOR</td> <td>1</td> <td>PZ</td> </tr> <tr> <td>VM1605A0</td> <td>CLIP TWIST LOCK DIAM. 10,2-12,7 MM</td> <td>3</td> <td>PZ</td> </tr> <tr> <td>VM2172A0</td> <td>PUMP-WITH-CI RCUIT LOCKING PIN</td> <td>9</td> <td>PZ</td> </tr> </tbody> </table>	Code	Description	Qty	UOM	VL1065A1	1/4 MALE N.O. PRESSURE SWITCH	1	PZ	VL1067A0	WASHING SYSTEM INLETS DISTRIBUTOR	1	PZ	VL1092A0	WASHING SYSTEM OUTLET DOUBLE DISTRIBUTOR	1	PZ	VL1102A1	DETERGENT LINE FILTER + BARBED VNR 6 MM	1	PZ	VL1127A1	6MM BARBED T-SHAPED FITTING	2	PZ	VL1128A0	D6 BARBED CHECK VALVE	3	PZ	VL1128A1	D6 BARBED CHECK VALVE	3	PZ	VL1165A0	BB6-AR6 STRAIGHT FITTING	4	PZ	VL1166A0	BB6-AR6 L FITTING	4	PZ	VL1167A0		1	PZ	VL1167A1		1	PZ	VL1167A2	GN21 3 ROTOR ARMS B-B FLOW RESTRICTOR	1	PZ	VL1174C0	D1.2 MM CALIBRATED NOZZLE	1	PZ	VL1185A0	2 WAYS PLUS WASHING DISTRIBUTOR	1	PZ	VL1186A0	3 WAYS PLUS WASHING DISTRIBUTOR	1	PZ	VL1190A0	PLUS WASHING SYSTEM INLET DISTRIBUTOR	1	PZ	VM1605A0	CLIP TWIST LOCK DIAM. 10,2-12,7 MM	3	PZ	VM2172A0	PUMP-WITH-CI RCUIT LOCKING PIN	9	PZ
Code	Description	Qty	UOM																																																																														
VL1065A1	1/4 MALE N.O. PRESSURE SWITCH	1	PZ																																																																														
VL1067A0	WASHING SYSTEM INLETS DISTRIBUTOR	1	PZ																																																																														
VL1092A0	WASHING SYSTEM OUTLET DOUBLE DISTRIBUTOR	1	PZ																																																																														
VL1102A1	DETERGENT LINE FILTER + BARBED VNR 6 MM	1	PZ																																																																														
VL1127A1	6MM BARBED T-SHAPED FITTING	2	PZ																																																																														
VL1128A0	D6 BARBED CHECK VALVE	3	PZ																																																																														
VL1128A1	D6 BARBED CHECK VALVE	3	PZ																																																																														
VL1165A0	BB6-AR6 STRAIGHT FITTING	4	PZ																																																																														
VL1166A0	BB6-AR6 L FITTING	4	PZ																																																																														
VL1167A0		1	PZ																																																																														
VL1167A1		1	PZ																																																																														
VL1167A2	GN21 3 ROTOR ARMS B-B FLOW RESTRICTOR	1	PZ																																																																														
VL1174C0	D1.2 MM CALIBRATED NOZZLE	1	PZ																																																																														
VL1185A0	2 WAYS PLUS WASHING DISTRIBUTOR	1	PZ																																																																														
VL1186A0	3 WAYS PLUS WASHING DISTRIBUTOR	1	PZ																																																																														
VL1190A0	PLUS WASHING SYSTEM INLET DISTRIBUTOR	1	PZ																																																																														
VM1605A0	CLIP TWIST LOCK DIAM. 10,2-12,7 MM	3	PZ																																																																														
VM2172A0	PUMP-WITH-CI RCUIT LOCKING PIN	9	PZ																																																																														

COMPONENT			SPARE PART																																																																																		
Code	Description	Image	Code	Description	Components list																																																																																
VL1019A	VIBRATION PUMP		KVL1184A	2 ROTOR ARMS PLUS EU CLEANING SYSTEM KIT	<table border="1"> <thead> <tr> <th>Code</th> <th>Description</th> <th>Qty</th> <th>UOM</th> </tr> </thead> <tbody> <tr> <td>0H2143A0</td> <td>LAMIERA BLOCCA VNR VL1128</td> <td>2</td> <td>PZ</td> </tr> <tr> <td>0H2168A0</td> <td></td> <td>1</td> <td>PZ</td> </tr> <tr> <td>0H2354A0</td> <td>XEVC-XEVL WASHING CIRCUIT PLAT</td> <td>1</td> <td>PZ</td> </tr> <tr> <td>EL1220A0</td> <td>JG STRAIGHT CONNECTION Ø8F-Ø8F</td> <td>3</td> <td>PZ</td> </tr> <tr> <td>EL1440A0</td> <td>WATER SELF CLEANING VALVE</td> <td>4</td> <td>PZ</td> </tr> <tr> <td>GN1526A0</td> <td>INT. D.=6.9 TH=1.8 O-RIN</td> <td>9</td> <td>PZ</td> </tr> <tr> <td>RC1018A0</td> <td>ZINC PLATED D12 ELASTIC CLAMP</td> <td>2</td> <td>PZ</td> </tr> <tr> <td>RC1019A0</td> <td>D=10 ELASTIC CLAMP</td> <td>21</td> <td>PZ</td> </tr> <tr> <td>RC1130A0</td> <td>130X2,6 CLAM</td> <td>7</td> <td>PZ</td> </tr> <tr> <td>RC1131A0</td> <td>200X2.6 BLACK CLAMP</td> <td>3</td> <td>PZ</td> </tr> <tr> <td>RC1242A0</td> <td>D=10 CLOSED CAP</td> <td>2</td> <td>PZ</td> </tr> <tr> <td>RC1356A0</td> <td>"STRAIGHT THREADED FEMALE END 8X1/4" BS</td> <td>1</td> <td>PZ</td> </tr> <tr> <td>TB2820A0</td> <td>6X10 EPDM PIPE FOR WASHING SYSTEM</td> <td>2.400</td> <td>M</td> </tr> <tr> <td>TB3132A0</td> <td>WHITE-BLUE EPDM TEXTILE BRAID HOSE 6X12</td> <td>1.220</td> <td>M</td> </tr> <tr> <td>VL1019A0</td> <td>VIBRATION PUMP</td> <td>1</td> <td>PZ</td> </tr> <tr> <td>VL1046A1</td> <td>D6 PIPE HOLDER - D6 J.G. TERMINAL</td> <td>3</td> <td>PZ</td> </tr> <tr> <td>VL1047A1</td> <td>D6 PIPE HOLDER - D8 J.G. TERMINAL</td> <td>1</td> <td>PZ</td> </tr> <tr> <td>VL1065A1</td> <td>1/4 MALE N.O. PRESSURE SWITCH</td> <td>1</td> <td>PZ</td> </tr> <tr> <td>VL1067A0</td> <td>WASHING SYSTEM INLETS DISTRIBUTOR</td> <td>1</td> <td>PZ</td> </tr> </tbody> </table>	Code	Description	Qty	UOM	0H2143A0	LAMIERA BLOCCA VNR VL1128	2	PZ	0H2168A0		1	PZ	0H2354A0	XEVC-XEVL WASHING CIRCUIT PLAT	1	PZ	EL1220A0	JG STRAIGHT CONNECTION Ø8F-Ø8F	3	PZ	EL1440A0	WATER SELF CLEANING VALVE	4	PZ	GN1526A0	INT. D.=6.9 TH=1.8 O-RIN	9	PZ	RC1018A0	ZINC PLATED D12 ELASTIC CLAMP	2	PZ	RC1019A0	D=10 ELASTIC CLAMP	21	PZ	RC1130A0	130X2,6 CLAM	7	PZ	RC1131A0	200X2.6 BLACK CLAMP	3	PZ	RC1242A0	D=10 CLOSED CAP	2	PZ	RC1356A0	"STRAIGHT THREADED FEMALE END 8X1/4" BS	1	PZ	TB2820A0	6X10 EPDM PIPE FOR WASHING SYSTEM	2.400	M	TB3132A0	WHITE-BLUE EPDM TEXTILE BRAID HOSE 6X12	1.220	M	VL1019A0	VIBRATION PUMP	1	PZ	VL1046A1	D6 PIPE HOLDER - D6 J.G. TERMINAL	3	PZ	VL1047A1	D6 PIPE HOLDER - D8 J.G. TERMINAL	1	PZ	VL1065A1	1/4 MALE N.O. PRESSURE SWITCH	1	PZ	VL1067A0	WASHING SYSTEM INLETS DISTRIBUTOR	1	PZ
Code	Description	Qty	UOM																																																																																		
0H2143A0	LAMIERA BLOCCA VNR VL1128	2	PZ																																																																																		
0H2168A0		1	PZ																																																																																		
0H2354A0	XEVC-XEVL WASHING CIRCUIT PLAT	1	PZ																																																																																		
EL1220A0	JG STRAIGHT CONNECTION Ø8F-Ø8F	3	PZ																																																																																		
EL1440A0	WATER SELF CLEANING VALVE	4	PZ																																																																																		
GN1526A0	INT. D.=6.9 TH=1.8 O-RIN	9	PZ																																																																																		
RC1018A0	ZINC PLATED D12 ELASTIC CLAMP	2	PZ																																																																																		
RC1019A0	D=10 ELASTIC CLAMP	21	PZ																																																																																		
RC1130A0	130X2,6 CLAM	7	PZ																																																																																		
RC1131A0	200X2.6 BLACK CLAMP	3	PZ																																																																																		
RC1242A0	D=10 CLOSED CAP	2	PZ																																																																																		
RC1356A0	"STRAIGHT THREADED FEMALE END 8X1/4" BS	1	PZ																																																																																		
TB2820A0	6X10 EPDM PIPE FOR WASHING SYSTEM	2.400	M																																																																																		
TB3132A0	WHITE-BLUE EPDM TEXTILE BRAID HOSE 6X12	1.220	M																																																																																		
VL1019A0	VIBRATION PUMP	1	PZ																																																																																		
VL1046A1	D6 PIPE HOLDER - D6 J.G. TERMINAL	3	PZ																																																																																		
VL1047A1	D6 PIPE HOLDER - D8 J.G. TERMINAL	1	PZ																																																																																		
VL1065A1	1/4 MALE N.O. PRESSURE SWITCH	1	PZ																																																																																		
VL1067A0	WASHING SYSTEM INLETS DISTRIBUTOR	1	PZ																																																																																		

COMPONENT			SPARE PART																																																						
Code	Description	Image	Code	Description	Components list																																																				
VL1019A	VIBRATION PUMP		KVL1184A	2 ROTOR ARMS PLUS EU CLEANING SYSTEM KIT	<table border="1"> <thead> <tr> <th>Code</th> <th>Description</th> <th>Qty</th> <th>UOM</th> </tr> </thead> <tbody> <tr> <td>VL1092A0</td> <td>WASHING SYSTEM OUTLET DOUBLE DISTRIBUTOR</td> <td>1</td> <td>PZ</td> </tr> <tr> <td>VL1102A1</td> <td>DETERGENT LINE FILTER + BARBED VNR 6 MM</td> <td>1</td> <td>PZ</td> </tr> <tr> <td>VL1128A0</td> <td>D6 BARBED CHECK VALVE</td> <td>2</td> <td>PZ</td> </tr> <tr> <td>VL1128A1</td> <td>D6 BARBED CHECK VALVE</td> <td>2</td> <td>PZ</td> </tr> <tr> <td>VL1141A1</td> <td>STRAIGHT CONNECT BB6-BB6</td> <td>1</td> <td>PZ</td> </tr> <tr> <td>VL1165A0</td> <td>BB6-AR6 STRAIGHT FITTING</td> <td>4</td> <td>PZ</td> </tr> <tr> <td>VL1166A0</td> <td>BB6-AR6 L FITTING</td> <td>4</td> <td>PZ</td> </tr> <tr> <td>VL1174C0</td> <td>D1.2 MM CALIBRATED NOZZLE</td> <td>1</td> <td>PZ</td> </tr> <tr> <td>VL1186A0</td> <td>3 WAYS PLUS WASHING DISTRIBUTOR</td> <td>1</td> <td>PZ</td> </tr> <tr> <td>VL1190A0</td> <td>PLUS WASHING SYSTEM INLET DISTRIBUTOR</td> <td>1</td> <td>PZ</td> </tr> <tr> <td>VM1605A0</td> <td>CLIP TWIST LOCK DIAM. 10,2-12,7 MM</td> <td>4</td> <td>PZ</td> </tr> <tr> <td>VM2172A0</td> <td>PUMP-WITH-CI RCUIT LOCKING PIN</td> <td>9</td> <td>PZ</td> </tr> </tbody> </table>	Code	Description	Qty	UOM	VL1092A0	WASHING SYSTEM OUTLET DOUBLE DISTRIBUTOR	1	PZ	VL1102A1	DETERGENT LINE FILTER + BARBED VNR 6 MM	1	PZ	VL1128A0	D6 BARBED CHECK VALVE	2	PZ	VL1128A1	D6 BARBED CHECK VALVE	2	PZ	VL1141A1	STRAIGHT CONNECT BB6-BB6	1	PZ	VL1165A0	BB6-AR6 STRAIGHT FITTING	4	PZ	VL1166A0	BB6-AR6 L FITTING	4	PZ	VL1174C0	D1.2 MM CALIBRATED NOZZLE	1	PZ	VL1186A0	3 WAYS PLUS WASHING DISTRIBUTOR	1	PZ	VL1190A0	PLUS WASHING SYSTEM INLET DISTRIBUTOR	1	PZ	VM1605A0	CLIP TWIST LOCK DIAM. 10,2-12,7 MM	4	PZ	VM2172A0	PUMP-WITH-CI RCUIT LOCKING PIN	9	PZ
Code	Description	Qty	UOM																																																						
VL1092A0	WASHING SYSTEM OUTLET DOUBLE DISTRIBUTOR	1	PZ																																																						
VL1102A1	DETERGENT LINE FILTER + BARBED VNR 6 MM	1	PZ																																																						
VL1128A0	D6 BARBED CHECK VALVE	2	PZ																																																						
VL1128A1	D6 BARBED CHECK VALVE	2	PZ																																																						
VL1141A1	STRAIGHT CONNECT BB6-BB6	1	PZ																																																						
VL1165A0	BB6-AR6 STRAIGHT FITTING	4	PZ																																																						
VL1166A0	BB6-AR6 L FITTING	4	PZ																																																						
VL1174C0	D1.2 MM CALIBRATED NOZZLE	1	PZ																																																						
VL1186A0	3 WAYS PLUS WASHING DISTRIBUTOR	1	PZ																																																						
VL1190A0	PLUS WASHING SYSTEM INLET DISTRIBUTOR	1	PZ																																																						
VM1605A0	CLIP TWIST LOCK DIAM. 10,2-12,7 MM	4	PZ																																																						
VM2172A0	PUMP-WITH-CI RCUIT LOCKING PIN	9	PZ																																																						
			KVL1183A	1 ROTOR ARM PLUS CLEANING SYSTEM KIT	<table border="1"> <thead> <tr> <th>Code</th> <th>Description</th> <th>Qty</th> <th>UOM</th> </tr> </thead> <tbody> <tr> <td>0H2143A0</td> <td>LAMIERA BLOCCA VNR VL1128</td> <td>2</td> <td>PZ</td> </tr> <tr> <td>0H2168A1</td> <td></td> <td>1</td> <td>PZ</td> </tr> <tr> <td>0H2354A0</td> <td>XEVC-XEVL WASHING CIRCUIT PLAT</td> <td>1</td> <td>PZ</td> </tr> <tr> <td>EL1440A0</td> <td>WATER SELF CLEANING VALVE</td> <td>3</td> <td>PZ</td> </tr> <tr> <td>GN1526A0</td> <td>INT. D.=6.9 TH=1.8 O-RIN</td> <td>7</td> <td>PZ</td> </tr> <tr> <td>RC1018A0</td> <td>ZINC PLATED D12 ELASTIC CLAMP</td> <td>2</td> <td>PZ</td> </tr> </tbody> </table>	Code	Description	Qty	UOM	0H2143A0	LAMIERA BLOCCA VNR VL1128	2	PZ	0H2168A1		1	PZ	0H2354A0	XEVC-XEVL WASHING CIRCUIT PLAT	1	PZ	EL1440A0	WATER SELF CLEANING VALVE	3	PZ	GN1526A0	INT. D.=6.9 TH=1.8 O-RIN	7	PZ	RC1018A0	ZINC PLATED D12 ELASTIC CLAMP	2	PZ																								
Code	Description	Qty	UOM																																																						
0H2143A0	LAMIERA BLOCCA VNR VL1128	2	PZ																																																						
0H2168A1		1	PZ																																																						
0H2354A0	XEVC-XEVL WASHING CIRCUIT PLAT	1	PZ																																																						
EL1440A0	WATER SELF CLEANING VALVE	3	PZ																																																						
GN1526A0	INT. D.=6.9 TH=1.8 O-RIN	7	PZ																																																						
RC1018A0	ZINC PLATED D12 ELASTIC CLAMP	2	PZ																																																						

COMPONENT			SPARE PART																																																																																		
Code	Description	Image	Code	Description	Components list																																																																																
VL1019A	VIBRATION PUMP		KVL1183A	1 ROTOR ARM PLUS CLEANING SYSTEM KIT	<table border="1"> <thead> <tr> <th>Code</th> <th>Description</th> <th>Qty</th> <th>UOM</th> </tr> </thead> <tbody> <tr> <td>RC1019A0</td> <td>D=10 ELASTIC CLAMP</td> <td>14</td> <td>PZ</td> </tr> <tr> <td>RC1130A0</td> <td>130X2,6 CLAM</td> <td>5</td> <td>PZ</td> </tr> <tr> <td>RC1131A0</td> <td>200X2.6 BLACK CLAMP</td> <td>2</td> <td>PZ</td> </tr> <tr> <td>RC1242A0</td> <td>D=10 CLOSED CAP</td> <td>2</td> <td>PZ</td> </tr> <tr> <td>RC1356A0</td> <td>"STRAIGHT THREADED FEMALE END 8X1/4" BS</td> <td>1</td> <td>PZ</td> </tr> <tr> <td>TB2820A0</td> <td>6X10 EPDM PIPE FOR WASHING SYSTEM</td> <td>1.410</td> <td>M</td> </tr> <tr> <td>TB3132A0</td> <td>WHITE-BLUE EPDM TEXTILE BRAID HOSE 6X12</td> <td>0.770</td> <td>M</td> </tr> <tr> <td>VI1220A1</td> <td>4,2X12 TCB SELF-TAPPING SCREW</td> <td>3</td> <td>PZ</td> </tr> <tr> <td>VL1019A0</td> <td>VIBRATION PUMP</td> <td>1</td> <td>PZ</td> </tr> <tr> <td>VL1047A1</td> <td>D6 PIPE HOLDER - D8 J.G. TERMINAL</td> <td>1</td> <td>PZ</td> </tr> <tr> <td>VL1065A1</td> <td>1/4 MALE N.O. PRESSURE SWITCH</td> <td>1</td> <td>PZ</td> </tr> <tr> <td>VL1102A1</td> <td>DETERGENT LINE FILTER + BARBED VNR 6 MM</td> <td>1</td> <td>PZ</td> </tr> <tr> <td>VL1128A0</td> <td>D6 BARBED CHECK VALVE</td> <td>2</td> <td>PZ</td> </tr> <tr> <td>VL1128A1</td> <td>D6 BARBED CHECK VALVE</td> <td>2</td> <td>PZ</td> </tr> <tr> <td>VL1165A0</td> <td>BB6-AR6 STRAIGHT FITTING</td> <td>1</td> <td>PZ</td> </tr> <tr> <td>VL1166A0</td> <td>BB6-AR6 L FITTING</td> <td>3</td> <td>PZ</td> </tr> <tr> <td>VL1174C0</td> <td>D1.2 MM CALIBRATED NOZZLE</td> <td>1</td> <td>PZ</td> </tr> <tr> <td>VL1185A0</td> <td>2 WAYS PLUS WASHING DISTRIBUTOR</td> <td>1</td> <td>PZ</td> </tr> <tr> <td>VL1190A0</td> <td>PLUS WASHING SYSTEM INLET DISTRIBUTOR</td> <td>1</td> <td>PZ</td> </tr> </tbody> </table>	Code	Description	Qty	UOM	RC1019A0	D=10 ELASTIC CLAMP	14	PZ	RC1130A0	130X2,6 CLAM	5	PZ	RC1131A0	200X2.6 BLACK CLAMP	2	PZ	RC1242A0	D=10 CLOSED CAP	2	PZ	RC1356A0	"STRAIGHT THREADED FEMALE END 8X1/4" BS	1	PZ	TB2820A0	6X10 EPDM PIPE FOR WASHING SYSTEM	1.410	M	TB3132A0	WHITE-BLUE EPDM TEXTILE BRAID HOSE 6X12	0.770	M	VI1220A1	4,2X12 TCB SELF-TAPPING SCREW	3	PZ	VL1019A0	VIBRATION PUMP	1	PZ	VL1047A1	D6 PIPE HOLDER - D8 J.G. TERMINAL	1	PZ	VL1065A1	1/4 MALE N.O. PRESSURE SWITCH	1	PZ	VL1102A1	DETERGENT LINE FILTER + BARBED VNR 6 MM	1	PZ	VL1128A0	D6 BARBED CHECK VALVE	2	PZ	VL1128A1	D6 BARBED CHECK VALVE	2	PZ	VL1165A0	BB6-AR6 STRAIGHT FITTING	1	PZ	VL1166A0	BB6-AR6 L FITTING	3	PZ	VL1174C0	D1.2 MM CALIBRATED NOZZLE	1	PZ	VL1185A0	2 WAYS PLUS WASHING DISTRIBUTOR	1	PZ	VL1190A0	PLUS WASHING SYSTEM INLET DISTRIBUTOR	1	PZ
Code	Description	Qty	UOM																																																																																		
RC1019A0	D=10 ELASTIC CLAMP	14	PZ																																																																																		
RC1130A0	130X2,6 CLAM	5	PZ																																																																																		
RC1131A0	200X2.6 BLACK CLAMP	2	PZ																																																																																		
RC1242A0	D=10 CLOSED CAP	2	PZ																																																																																		
RC1356A0	"STRAIGHT THREADED FEMALE END 8X1/4" BS	1	PZ																																																																																		
TB2820A0	6X10 EPDM PIPE FOR WASHING SYSTEM	1.410	M																																																																																		
TB3132A0	WHITE-BLUE EPDM TEXTILE BRAID HOSE 6X12	0.770	M																																																																																		
VI1220A1	4,2X12 TCB SELF-TAPPING SCREW	3	PZ																																																																																		
VL1019A0	VIBRATION PUMP	1	PZ																																																																																		
VL1047A1	D6 PIPE HOLDER - D8 J.G. TERMINAL	1	PZ																																																																																		
VL1065A1	1/4 MALE N.O. PRESSURE SWITCH	1	PZ																																																																																		
VL1102A1	DETERGENT LINE FILTER + BARBED VNR 6 MM	1	PZ																																																																																		
VL1128A0	D6 BARBED CHECK VALVE	2	PZ																																																																																		
VL1128A1	D6 BARBED CHECK VALVE	2	PZ																																																																																		
VL1165A0	BB6-AR6 STRAIGHT FITTING	1	PZ																																																																																		
VL1166A0	BB6-AR6 L FITTING	3	PZ																																																																																		
VL1174C0	D1.2 MM CALIBRATED NOZZLE	1	PZ																																																																																		
VL1185A0	2 WAYS PLUS WASHING DISTRIBUTOR	1	PZ																																																																																		
VL1190A0	PLUS WASHING SYSTEM INLET DISTRIBUTOR	1	PZ																																																																																		



COMPONENT			SPARE PART																																																																			
Code	Description	Image	Code	Description	Components list																																																																	
VL1019A	VIBRATION PUMP		KVL1183A	1 ROTOR ARM PLUS CLEANING SYSTEM KIT	<table border="1"> <thead> <tr> <th>Code</th> <th>Description</th> <th>Qty</th> <th>UOM</th> </tr> </thead> <tbody> <tr> <td>VM1605A0</td> <td>CLIP TWIST LOCK DIAM. 10,2-12,7 MM</td> <td>3</td> <td>PZ</td> </tr> <tr> <td>VM2172A0</td> <td>PUMP-WITH-CI RCUIT LOCKING PIN</td> <td>7</td> <td>PZ</td> </tr> </tbody> </table>	Code	Description	Qty	UOM	VM1605A0	CLIP TWIST LOCK DIAM. 10,2-12,7 MM	3	PZ	VM2172A0	PUMP-WITH-CI RCUIT LOCKING PIN	7	PZ																																																					
			Code	Description	Qty	UOM																																																																
VM1605A0	CLIP TWIST LOCK DIAM. 10,2-12,7 MM	3	PZ																																																																			
VM2172A0	PUMP-WITH-CI RCUIT LOCKING PIN	7	PZ																																																																			
KVL1182A	ONE CLEANING SYSTEM KIT (0311 EXC.)	<table border="1"> <thead> <tr> <th>Code</th> <th>Description</th> <th>Qty</th> <th>UOM</th> </tr> </thead> <tbody> <tr> <td>0H2143A0</td> <td>LAMIERA BLOCCA VNR VL1128</td> <td>2</td> <td>PZ</td> </tr> <tr> <td>0H2202A1</td> <td>ONE WASHING WITH STEAM VALVE SUPPORT</td> <td>1</td> <td>PZ</td> </tr> <tr> <td>EL1440A0</td> <td>WATER SELF CLEANING VALVE</td> <td>1</td> <td>PZ</td> </tr> <tr> <td>GN1526A0</td> <td>INT. D.=6.9 TH=1.8 O-RIN</td> <td>3</td> <td>PZ</td> </tr> <tr> <td>RC1018A0</td> <td>ZINC PLATED D12 ELASTIC CLAMP</td> <td>1</td> <td>PZ</td> </tr> <tr> <td>RC1019A0</td> <td>D=10 ELASTIC CLAMP</td> <td>14</td> <td>PZ</td> </tr> <tr> <td>RC1130A0</td> <td>130X2,6 CLAM</td> <td>2</td> <td>PZ</td> </tr> <tr> <td>RC1242A0</td> <td>D=10 CLOSED CAP</td> <td>2</td> <td>PZ</td> </tr> <tr> <td>TB2820A0</td> <td>6X10 EPDM PIPE FOR WASHING SYSTEM</td> <td>1.410</td> <td>M</td> </tr> <tr> <td>TB3132A0</td> <td>WHITE-BLUE EPDM TEXTILE BRAID HOSE 6X12</td> <td>0.670</td> <td>M</td> </tr> <tr> <td>VI1220A1</td> <td>4,2X12 TCB SELF-TAPPIN G SCREW</td> <td>1</td> <td>PZ</td> </tr> <tr> <td>VL1019A0</td> <td>VIBRATION PUMP</td> <td>1</td> <td>PZ</td> </tr> <tr> <td>VL1047A1</td> <td>D6 PIPE HOLDER - D8 J.G. TERMINAL</td> <td>1</td> <td>PZ</td> </tr> <tr> <td>VL1054B0</td> <td>ONE WASHING SYS INLET DISTRIBUTOR</td> <td>1</td> <td>PZ</td> </tr> <tr> <td>VL1102A1</td> <td>DETERGENT LINE FILTER + BARBED VNR 6 MM</td> <td>1</td> <td>PZ</td> </tr> <tr> <td>VL1128A0</td> <td>D6 BARBED CHECK VALVE</td> <td>2</td> <td>PZ</td> </tr> </tbody> </table>	Code	Description	Qty	UOM	0H2143A0	LAMIERA BLOCCA VNR VL1128	2	PZ	0H2202A1	ONE WASHING WITH STEAM VALVE SUPPORT	1	PZ	EL1440A0	WATER SELF CLEANING VALVE	1	PZ	GN1526A0	INT. D.=6.9 TH=1.8 O-RIN	3	PZ	RC1018A0	ZINC PLATED D12 ELASTIC CLAMP	1	PZ	RC1019A0	D=10 ELASTIC CLAMP	14	PZ	RC1130A0	130X2,6 CLAM	2	PZ	RC1242A0	D=10 CLOSED CAP	2	PZ	TB2820A0	6X10 EPDM PIPE FOR WASHING SYSTEM	1.410	M	TB3132A0	WHITE-BLUE EPDM TEXTILE BRAID HOSE 6X12	0.670	M	VI1220A1	4,2X12 TCB SELF-TAPPIN G SCREW	1	PZ	VL1019A0	VIBRATION PUMP	1	PZ	VL1047A1	D6 PIPE HOLDER - D8 J.G. TERMINAL	1	PZ	VL1054B0	ONE WASHING SYS INLET DISTRIBUTOR	1	PZ	VL1102A1	DETERGENT LINE FILTER + BARBED VNR 6 MM	1	PZ	VL1128A0	D6 BARBED CHECK VALVE	2	PZ
Code	Description	Qty	UOM																																																																			
0H2143A0	LAMIERA BLOCCA VNR VL1128	2	PZ																																																																			
0H2202A1	ONE WASHING WITH STEAM VALVE SUPPORT	1	PZ																																																																			
EL1440A0	WATER SELF CLEANING VALVE	1	PZ																																																																			
GN1526A0	INT. D.=6.9 TH=1.8 O-RIN	3	PZ																																																																			
RC1018A0	ZINC PLATED D12 ELASTIC CLAMP	1	PZ																																																																			
RC1019A0	D=10 ELASTIC CLAMP	14	PZ																																																																			
RC1130A0	130X2,6 CLAM	2	PZ																																																																			
RC1242A0	D=10 CLOSED CAP	2	PZ																																																																			
TB2820A0	6X10 EPDM PIPE FOR WASHING SYSTEM	1.410	M																																																																			
TB3132A0	WHITE-BLUE EPDM TEXTILE BRAID HOSE 6X12	0.670	M																																																																			
VI1220A1	4,2X12 TCB SELF-TAPPIN G SCREW	1	PZ																																																																			
VL1019A0	VIBRATION PUMP	1	PZ																																																																			
VL1047A1	D6 PIPE HOLDER - D8 J.G. TERMINAL	1	PZ																																																																			
VL1054B0	ONE WASHING SYS INLET DISTRIBUTOR	1	PZ																																																																			
VL1102A1	DETERGENT LINE FILTER + BARBED VNR 6 MM	1	PZ																																																																			
VL1128A0	D6 BARBED CHECK VALVE	2	PZ																																																																			

COMPONENT			SPARE PART																																																			
Code	Description	Image	Code	Description	Components list																																																	
VL1019A	VIBRATION PUMP		KVL1182A	ONE CLEANING SYSTEM KIT (0311 EXC.)	<table border="1"> <thead> <tr> <th>Code</th> <th>Description</th> <th>Qty</th> <th>UOM</th> </tr> </thead> <tbody> <tr> <td>VL1128A1</td> <td>D6 BARBED CHECK VALVE</td> <td>2</td> <td>PZ</td> </tr> <tr> <td>VL1165A0</td> <td>BB6-AR6 STRAIGHT FITTING</td> <td>1</td> <td>PZ</td> </tr> <tr> <td>VL1166A0</td> <td>BB6-AR6 L FITTING</td> <td>1</td> <td>PZ</td> </tr> <tr> <td>VL1174C0</td> <td>D1.2 MM CALIBRATED NOZZLE</td> <td>1</td> <td>PZ</td> </tr> <tr> <td>VL1191A0</td> <td>ONE WASHING DISTRIBUTOR OUTLETS KIT</td> <td>1</td> <td>PZ</td> </tr> <tr> <td>VM1605A0</td> <td>CLIP TWIST LOCK DIAM. 10,2-12,7 MM</td> <td>3</td> <td>PZ</td> </tr> <tr> <td>VM2172A0</td> <td>PUMP-WITH-CI RCUIT LOCKING PIN</td> <td>2</td> <td>PZ</td> </tr> </tbody> </table>	Code	Description	Qty	UOM	VL1128A1	D6 BARBED CHECK VALVE	2	PZ	VL1165A0	BB6-AR6 STRAIGHT FITTING	1	PZ	VL1166A0	BB6-AR6 L FITTING	1	PZ	VL1174C0	D1.2 MM CALIBRATED NOZZLE	1	PZ	VL1191A0	ONE WASHING DISTRIBUTOR OUTLETS KIT	1	PZ	VM1605A0	CLIP TWIST LOCK DIAM. 10,2-12,7 MM	3	PZ	VM2172A0	PUMP-WITH-CI RCUIT LOCKING PIN	2	PZ																	
			Code	Description	Qty	UOM																																																
VL1128A1	D6 BARBED CHECK VALVE	2	PZ																																																			
VL1165A0	BB6-AR6 STRAIGHT FITTING	1	PZ																																																			
VL1166A0	BB6-AR6 L FITTING	1	PZ																																																			
VL1174C0	D1.2 MM CALIBRATED NOZZLE	1	PZ																																																			
VL1191A0	ONE WASHING DISTRIBUTOR OUTLETS KIT	1	PZ																																																			
VM1605A0	CLIP TWIST LOCK DIAM. 10,2-12,7 MM	3	PZ																																																			
VM2172A0	PUMP-WITH-CI RCUIT LOCKING PIN	2	PZ																																																			
KVL0684A	2-3 ROTOR ARM PLUS WASH PUMP+NOZZLE KIT	<table border="1"> <thead> <tr> <th>Code</th> <th>Description</th> <th>Qty</th> <th>UOM</th> </tr> </thead> <tbody> <tr> <td>GN1526A0</td> <td>INT. D.=6.9 TH=1.8 O-RING</td> <td>4</td> <td>PZ</td> </tr> <tr> <td>RC1019A0</td> <td>D=10 ELASTIC CLAMP</td> <td>4</td> <td>PZ</td> </tr> <tr> <td>RC1130A0</td> <td>130X2,6 CLAM</td> <td>1</td> <td>PZ</td> </tr> <tr> <td>RC1131A0</td> <td>200X2,6 BLACK CLAMP</td> <td>3</td> <td>PZ</td> </tr> <tr> <td>RC1242A0</td> <td>D=10 CLOSED CAP</td> <td>2</td> <td>PZ</td> </tr> <tr> <td>TB2820A0</td> <td>6X10 EPDM PIPE FOR WASHING SYSTEM</td> <td>0.120</td> <td>M</td> </tr> <tr> <td>VL1019A0</td> <td>VIBRATION PUMP</td> <td>1</td> <td>PZ</td> </tr> <tr> <td>VL1128A1</td> <td>D6 BARBED CHECK VALVE</td> <td>1</td> <td>PZ</td> </tr> <tr> <td>VL1174C0</td> <td>D1.2 MM CALIBRATED NOZZLE</td> <td>1</td> <td>PZ</td> </tr> <tr> <td>VL1186A0</td> <td>3 WAYS PLUS WASHING DISTRIBUTOR</td> <td>1</td> <td>PZ</td> </tr> <tr> <td>VL1190A0</td> <td>PLUS WASHING SYSTEM INLET DISTRIBUTOR</td> <td>1</td> <td>PZ</td> </tr> <tr> <td>VM2172A0</td> <td>PUMP-WITH-CI RCUIT LOCKING PIN</td> <td>1</td> <td>PZ</td> </tr> </tbody> </table>	Code	Description	Qty	UOM	GN1526A0	INT. D.=6.9 TH=1.8 O-RING	4	PZ	RC1019A0	D=10 ELASTIC CLAMP	4	PZ	RC1130A0	130X2,6 CLAM	1	PZ	RC1131A0	200X2,6 BLACK CLAMP	3	PZ	RC1242A0	D=10 CLOSED CAP	2	PZ	TB2820A0	6X10 EPDM PIPE FOR WASHING SYSTEM	0.120	M	VL1019A0	VIBRATION PUMP	1	PZ	VL1128A1	D6 BARBED CHECK VALVE	1	PZ	VL1174C0	D1.2 MM CALIBRATED NOZZLE	1	PZ	VL1186A0	3 WAYS PLUS WASHING DISTRIBUTOR	1	PZ	VL1190A0	PLUS WASHING SYSTEM INLET DISTRIBUTOR	1	PZ	VM2172A0	PUMP-WITH-CI RCUIT LOCKING PIN	1	PZ
Code	Description	Qty	UOM																																																			
GN1526A0	INT. D.=6.9 TH=1.8 O-RING	4	PZ																																																			
RC1019A0	D=10 ELASTIC CLAMP	4	PZ																																																			
RC1130A0	130X2,6 CLAM	1	PZ																																																			
RC1131A0	200X2,6 BLACK CLAMP	3	PZ																																																			
RC1242A0	D=10 CLOSED CAP	2	PZ																																																			
TB2820A0	6X10 EPDM PIPE FOR WASHING SYSTEM	0.120	M																																																			
VL1019A0	VIBRATION PUMP	1	PZ																																																			
VL1128A1	D6 BARBED CHECK VALVE	1	PZ																																																			
VL1174C0	D1.2 MM CALIBRATED NOZZLE	1	PZ																																																			
VL1186A0	3 WAYS PLUS WASHING DISTRIBUTOR	1	PZ																																																			
VL1190A0	PLUS WASHING SYSTEM INLET DISTRIBUTOR	1	PZ																																																			
VM2172A0	PUMP-WITH-CI RCUIT LOCKING PIN	1	PZ																																																			



COMPONENT			SPARE PART																																																																																													
Code	Description	Image	Code	Description	Components list																																																																																											
VL1019A	VIBRATION PUMP		KVL0683A	1 ROTOR ARM PLUS WASH PUMP+NOZZLE KIT	<table border="1"> <thead> <tr> <th>Code</th> <th>Description</th> <th>Qty</th> <th>UOM</th> </tr> </thead> <tbody> <tr> <td>GN1526A0</td> <td>INT. D.=6.9 TH=1.8 O-RIN</td> <td>3</td> <td>PZ</td> </tr> <tr> <td>RC1019A0</td> <td>D=10 ELASTIC CLAMP</td> <td>4</td> <td>PZ</td> </tr> <tr> <td>RC1130A0</td> <td>130X2,6 CLAM</td> <td>1</td> <td>PZ</td> </tr> <tr> <td>RC1131A0</td> <td>200X2,6 BLACK CLAMP</td> <td>2</td> <td>PZ</td> </tr> <tr> <td>RC1242A0</td> <td>D=10 CLOSED CAP</td> <td>2</td> <td>PZ</td> </tr> <tr> <td>TB2820A0</td> <td>6X10 EPDM PIPE FOR WASHING SYSTEM</td> <td>0.120</td> <td>M</td> </tr> <tr> <td>VL1019A0</td> <td>VIBRATION PUMP</td> <td>1</td> <td>PZ</td> </tr> <tr> <td>VL1128A1</td> <td>D6 BARBED CHECK VALVE</td> <td>1</td> <td>PZ</td> </tr> <tr> <td>VL1174C0</td> <td>D1.2 MM CALIBRATED NOZZLE</td> <td>1</td> <td>PZ</td> </tr> <tr> <td>VL1185A0</td> <td>2 WAYS PLUS WASHING DISTRIBUTOR</td> <td>1</td> <td>PZ</td> </tr> <tr> <td>VL1190A0</td> <td>PLUS WASHING SYSTEM INLET DISTRIBUTOR</td> <td>1</td> <td>PZ</td> </tr> <tr> <td>VM2172A0</td> <td>PUMP-WITH-CI RCUIT LOCKING PIN</td> <td>1</td> <td>PZ</td> </tr> </tbody> </table>	Code	Description	Qty	UOM	GN1526A0	INT. D.=6.9 TH=1.8 O-RIN	3	PZ	RC1019A0	D=10 ELASTIC CLAMP	4	PZ	RC1130A0	130X2,6 CLAM	1	PZ	RC1131A0	200X2,6 BLACK CLAMP	2	PZ	RC1242A0	D=10 CLOSED CAP	2	PZ	TB2820A0	6X10 EPDM PIPE FOR WASHING SYSTEM	0.120	M	VL1019A0	VIBRATION PUMP	1	PZ	VL1128A1	D6 BARBED CHECK VALVE	1	PZ	VL1174C0	D1.2 MM CALIBRATED NOZZLE	1	PZ	VL1185A0	2 WAYS PLUS WASHING DISTRIBUTOR	1	PZ	VL1190A0	PLUS WASHING SYSTEM INLET DISTRIBUTOR	1	PZ	VM2172A0	PUMP-WITH-CI RCUIT LOCKING PIN	1	PZ	KVL0682A	ONE+HOODS WASHING SYSTEM PUMP+NOZZLE KIT	<table border="1"> <thead> <tr> <th>Code</th> <th>Description</th> <th>Qty</th> <th>UOM</th> </tr> </thead> <tbody> <tr> <td>GN1526A0</td> <td>INT. D.=6.9 TH=1.8 O-RIN</td> <td>1</td> <td>PZ</td> </tr> <tr> <td>RC1019A0</td> <td>D=10 ELASTIC CLAMP</td> <td>3</td> <td>PZ</td> </tr> <tr> <td>RC1242A0</td> <td>D=10 CLOSED CAP</td> <td>2</td> <td>PZ</td> </tr> <tr> <td>TB2820A0</td> <td>6X10 EPDM PIPE FOR WASHING SYSTEM</td> <td>0.120</td> <td>M</td> </tr> <tr> <td>VL1019A0</td> <td>VIBRATION PUMP</td> <td>1</td> <td>PZ</td> </tr> <tr> <td>VL1054B0</td> <td>ONE WASHING SYS INLET DISTRIBUTOR</td> <td>1</td> <td>PZ</td> </tr> <tr> <td>VL1128A1</td> <td>D6 BARBED CHECK VALVE</td> <td>2</td> <td>PZ</td> </tr> <tr> <td>VL1174C0</td> <td>D1.2 MM CALIBRATED NOZZLE</td> <td>1</td> <td>PZ</td> </tr> </tbody> </table>	Code	Description	Qty	UOM	GN1526A0	INT. D.=6.9 TH=1.8 O-RIN	1	PZ	RC1019A0	D=10 ELASTIC CLAMP	3	PZ	RC1242A0	D=10 CLOSED CAP	2	PZ	TB2820A0	6X10 EPDM PIPE FOR WASHING SYSTEM	0.120	M	VL1019A0	VIBRATION PUMP	1	PZ	VL1054B0	ONE WASHING SYS INLET DISTRIBUTOR	1	PZ	VL1128A1	D6 BARBED CHECK VALVE	2	PZ	VL1174C0	D1.2 MM CALIBRATED NOZZLE	1	PZ
			Code	Description	Qty	UOM																																																																																										
GN1526A0	INT. D.=6.9 TH=1.8 O-RIN	3	PZ																																																																																													
RC1019A0	D=10 ELASTIC CLAMP	4	PZ																																																																																													
RC1130A0	130X2,6 CLAM	1	PZ																																																																																													
RC1131A0	200X2,6 BLACK CLAMP	2	PZ																																																																																													
RC1242A0	D=10 CLOSED CAP	2	PZ																																																																																													
TB2820A0	6X10 EPDM PIPE FOR WASHING SYSTEM	0.120	M																																																																																													
VL1019A0	VIBRATION PUMP	1	PZ																																																																																													
VL1128A1	D6 BARBED CHECK VALVE	1	PZ																																																																																													
VL1174C0	D1.2 MM CALIBRATED NOZZLE	1	PZ																																																																																													
VL1185A0	2 WAYS PLUS WASHING DISTRIBUTOR	1	PZ																																																																																													
VL1190A0	PLUS WASHING SYSTEM INLET DISTRIBUTOR	1	PZ																																																																																													
VM2172A0	PUMP-WITH-CI RCUIT LOCKING PIN	1	PZ																																																																																													
Code	Description	Qty	UOM																																																																																													
GN1526A0	INT. D.=6.9 TH=1.8 O-RIN	1	PZ																																																																																													
RC1019A0	D=10 ELASTIC CLAMP	3	PZ																																																																																													
RC1242A0	D=10 CLOSED CAP	2	PZ																																																																																													
TB2820A0	6X10 EPDM PIPE FOR WASHING SYSTEM	0.120	M																																																																																													
VL1019A0	VIBRATION PUMP	1	PZ																																																																																													
VL1054B0	ONE WASHING SYS INLET DISTRIBUTOR	1	PZ																																																																																													
VL1128A1	D6 BARBED CHECK VALVE	2	PZ																																																																																													
VL1174C0	D1.2 MM CALIBRATED NOZZLE	1	PZ																																																																																													

COMPONENT			SPARE PART																																																															
Code	Description	Image	Code	Description	Components list																																																													
VL1019A	VIBRATION PUMP		KVL0682A	ONE+HOODS WASHING SYSTEM PUMP+NOZZLE KIT	<table border="1"> <thead> <tr> <th>Code</th> <th>Description</th> <th>Qty</th> <th>UOM</th> </tr> </thead> <tbody> <tr> <td>VL1191A0</td> <td>ONE WASHING DISTRIBUTOR OUTLETS KIT</td> <td>1</td> <td>PZ</td> </tr> <tr> <td>VM2172A0</td> <td>PUMP-WITH-CI RCUIT LOCKING PIN</td> <td>1</td> <td>PZ</td> </tr> </tbody> </table>	Code	Description	Qty	UOM	VL1191A0	ONE WASHING DISTRIBUTOR OUTLETS KIT	1	PZ	VM2172A0	PUMP-WITH-CI RCUIT LOCKING PIN	1	PZ																																																	
			Code	Description	Qty	UOM																																																												
VL1191A0	ONE WASHING DISTRIBUTOR OUTLETS KIT	1	PZ																																																															
VM2172A0	PUMP-WITH-CI RCUIT LOCKING PIN	1	PZ																																																															
KVL0001A	LM TOP CLEANING SYSTEM KIT	<table border="1"> <thead> <tr> <th>Code</th> <th>Description</th> <th>Qty</th> <th>UOM</th> </tr> </thead> <tbody> <tr> <td>0H1226B0</td> <td>LINEMISSTOP WASHING SYTEM CIRCUIT COVE</td> <td>1</td> <td>PZ</td> </tr> <tr> <td>0H2143A0</td> <td>LAMIERA BLOCCA VNR VL1128</td> <td>2</td> <td>PZ</td> </tr> <tr> <td>EL1436B0</td> <td>JG D8-BARBED D6 NRV WATER SOLENOID</td> <td>1</td> <td>PZ</td> </tr> <tr> <td>GN1312A0</td> <td>RUBBER CABLE-PASSI NG DE=26 DI=15 SP=10</td> <td>1</td> <td>PZ</td> </tr> <tr> <td>GN1526A0</td> <td>INT. D.=6.9 TH=1.8 O-RIN</td> <td>1</td> <td>PZ</td> </tr> <tr> <td>RC1019A0</td> <td>D=10 ELASTIC CLAMP</td> <td>5</td> <td>PZ</td> </tr> <tr> <td>RC1242A0</td> <td>D=10 CLOSED CAP</td> <td>2</td> <td>PZ</td> </tr> <tr> <td>RC1381A0</td> <td>BIFILAR PIPE CLIP D10,7</td> <td>3</td> <td>PZ</td> </tr> <tr> <td>TB2343A0</td> <td>9X6 PVC TRANSPAREN T PIPE</td> <td>1.650</td> <td>M</td> </tr> <tr> <td>TB2820A0</td> <td>6X10 EPDM PIPE FOR WASHING SYSTEM</td> <td>0.990</td> <td>M</td> </tr> <tr> <td>VI1220A1</td> <td>4,2X12 TCB SELF-TAPPIN G SCREW</td> <td>1</td> <td>PZ</td> </tr> <tr> <td>VL1019A0</td> <td>VIBRATION PUMP</td> <td>1</td> <td>PZ</td> </tr> <tr> <td>VL1041C0</td> <td>DETERGENT CAP WITH Ø12 HOLE</td> <td>1</td> <td>PZ</td> </tr> <tr> <td>VL1047A1</td> <td>D6 PIPE HOLDER - D8 J.G. TERMINAL</td> <td>1</td> <td>PZ</td> </tr> <tr> <td>VL1053B0</td> <td>ONE WASHING SYS EXT DISTRIBUTOR</td> <td>1</td> <td>PZ</td> </tr> </tbody> </table>	Code	Description	Qty	UOM	0H1226B0	LINEMISSTOP WASHING SYTEM CIRCUIT COVE	1	PZ	0H2143A0	LAMIERA BLOCCA VNR VL1128	2	PZ	EL1436B0	JG D8-BARBED D6 NRV WATER SOLENOID	1	PZ	GN1312A0	RUBBER CABLE-PASSI NG DE=26 DI=15 SP=10	1	PZ	GN1526A0	INT. D.=6.9 TH=1.8 O-RIN	1	PZ	RC1019A0	D=10 ELASTIC CLAMP	5	PZ	RC1242A0	D=10 CLOSED CAP	2	PZ	RC1381A0	BIFILAR PIPE CLIP D10,7	3	PZ	TB2343A0	9X6 PVC TRANSPAREN T PIPE	1.650	M	TB2820A0	6X10 EPDM PIPE FOR WASHING SYSTEM	0.990	M	VI1220A1	4,2X12 TCB SELF-TAPPIN G SCREW	1	PZ	VL1019A0	VIBRATION PUMP	1	PZ	VL1041C0	DETERGENT CAP WITH Ø12 HOLE	1	PZ	VL1047A1	D6 PIPE HOLDER - D8 J.G. TERMINAL	1	PZ	VL1053B0	ONE WASHING SYS EXT DISTRIBUTOR	1	PZ
Code	Description	Qty	UOM																																																															
0H1226B0	LINEMISSTOP WASHING SYTEM CIRCUIT COVE	1	PZ																																																															
0H2143A0	LAMIERA BLOCCA VNR VL1128	2	PZ																																																															
EL1436B0	JG D8-BARBED D6 NRV WATER SOLENOID	1	PZ																																																															
GN1312A0	RUBBER CABLE-PASSI NG DE=26 DI=15 SP=10	1	PZ																																																															
GN1526A0	INT. D.=6.9 TH=1.8 O-RIN	1	PZ																																																															
RC1019A0	D=10 ELASTIC CLAMP	5	PZ																																																															
RC1242A0	D=10 CLOSED CAP	2	PZ																																																															
RC1381A0	BIFILAR PIPE CLIP D10,7	3	PZ																																																															
TB2343A0	9X6 PVC TRANSPAREN T PIPE	1.650	M																																																															
TB2820A0	6X10 EPDM PIPE FOR WASHING SYSTEM	0.990	M																																																															
VI1220A1	4,2X12 TCB SELF-TAPPIN G SCREW	1	PZ																																																															
VL1019A0	VIBRATION PUMP	1	PZ																																																															
VL1041C0	DETERGENT CAP WITH Ø12 HOLE	1	PZ																																																															
VL1047A1	D6 PIPE HOLDER - D8 J.G. TERMINAL	1	PZ																																																															
VL1053B0	ONE WASHING SYS EXT DISTRIBUTOR	1	PZ																																																															



COMPONENT			SPARE PART																																						
Code	Description	Image	Code	Description	Components list																																				
VL1019A	VIBRATION PUMP		KVL0001A	LM TOP CLEANING SYSTEM KIT	<table border="1"> <thead> <tr> <th>Code</th> <th>Description</th> <th>Qty</th> <th>UOM</th> </tr> </thead> <tbody> <tr> <td>VL1054B0</td> <td>ONE WASHING SYS INLET DISTRIBUTOR</td> <td>1</td> <td>PZ</td> </tr> <tr> <td>VL1061A0</td> <td>HOLD DOWN WEIGHT+NET FILTER+NON-RET. V.</td> <td>1</td> <td>PZ</td> </tr> <tr> <td>VL1128A0</td> <td>D6 BARBED CHECK VALVE</td> <td>2</td> <td>PZ</td> </tr> <tr> <td>VL1128A1</td> <td>D6 BARBED CHECK VALVE</td> <td>2</td> <td>PZ</td> </tr> <tr> <td>VM1066A0</td> <td>SADDLE CLIP FOR CABLES PASSING</td> <td>3</td> <td>PZ</td> </tr> <tr> <td>VM1088A0</td> <td>NYLON CLICK CLAMP D7.9-D9.2</td> <td>1</td> <td>PZ</td> </tr> <tr> <td>VM1605A0</td> <td>CLIP TWIST LOCK DIAM. 10.2-12.7 MM</td> <td>1</td> <td>PZ</td> </tr> <tr> <td>VM2172A0</td> <td>PUMP-WITH-CL RCUIT LOCKING PIN</td> <td>1</td> <td>PZ</td> </tr> </tbody> </table>	Code	Description	Qty	UOM	VL1054B0	ONE WASHING SYS INLET DISTRIBUTOR	1	PZ	VL1061A0	HOLD DOWN WEIGHT+NET FILTER+NON-RET. V.	1	PZ	VL1128A0	D6 BARBED CHECK VALVE	2	PZ	VL1128A1	D6 BARBED CHECK VALVE	2	PZ	VM1066A0	SADDLE CLIP FOR CABLES PASSING	3	PZ	VM1088A0	NYLON CLICK CLAMP D7.9-D9.2	1	PZ	VM1605A0	CLIP TWIST LOCK DIAM. 10.2-12.7 MM	1	PZ	VM2172A0	PUMP-WITH-CL RCUIT LOCKING PIN	1	PZ
					Code	Description	Qty	UOM																																	
					VL1054B0	ONE WASHING SYS INLET DISTRIBUTOR	1	PZ																																	
					VL1061A0	HOLD DOWN WEIGHT+NET FILTER+NON-RET. V.	1	PZ																																	
					VL1128A0	D6 BARBED CHECK VALVE	2	PZ																																	
					VL1128A1	D6 BARBED CHECK VALVE	2	PZ																																	
					VM1066A0	SADDLE CLIP FOR CABLES PASSING	3	PZ																																	
					VM1088A0	NYLON CLICK CLAMP D7.9-D9.2	1	PZ																																	
					VM1605A0	CLIP TWIST LOCK DIAM. 10.2-12.7 MM	1	PZ																																	
					VM2172A0	PUMP-WITH-CL RCUIT LOCKING PIN	1	PZ																																	
GN1526A	INT. D.=6.9 TH=1.8 O-RING		KGN1526A	O-RING INT D6.9 THICK1.8 10PCS KIT	<table border="1"> <thead> <tr> <th>Code</th> <th>Description</th> <th>Qty</th> <th>UOM</th> </tr> </thead> <tbody> <tr> <td>GN1526A0</td> <td>INT. D.=6.9 TH=1.8 O-RIN</td> <td>10</td> <td>PZ</td> </tr> </tbody> </table>	Code	Description	Qty	UOM	GN1526A0	INT. D.=6.9 TH=1.8 O-RIN	10	PZ																												
Code	Description	Qty	UOM																																						
GN1526A0	INT. D.=6.9 TH=1.8 O-RIN	10	PZ																																						
RC1019A	D=10 ELASTIC CLAM		KRC1019A	Ø10 ZINC PLATED ELASTIC CLAMP 15 PCS KIT	<table border="1"> <thead> <tr> <th>Code</th> <th>Description</th> <th>Qty</th> <th>UOM</th> </tr> </thead> <tbody> <tr> <td>RC1019A0</td> <td>D=10 ELASTIC CLAMP</td> <td>17</td> <td>PZ</td> </tr> <tr> <td>VM1224A0</td> <td>65MY 220MM 2 COLOURS SHRINK TUBE</td> <td>0.200</td> <td>M</td> </tr> </tbody> </table>	Code	Description	Qty	UOM	RC1019A0	D=10 ELASTIC CLAMP	17	PZ	VM1224A0	65MY 220MM 2 COLOURS SHRINK TUBE	0.200	M																								
					Code	Description	Qty	UOM																																	
RC1019A0	D=10 ELASTIC CLAMP	17	PZ																																						
VM1224A0	65MY 220MM 2 COLOURS SHRINK TUBE	0.200	M																																						



COMPONENT			SPARE PART																														
Code	Description	Image	Code	Description	Components list																												
VL1065A	1/4 MALE N.O. PRESSURE SWITCH		KVL1065A	1/4 M N.O. CIL. PRESSURE SWITCH KIT	<table border="1"> <thead> <tr> <th>Code</th> <th>Description</th> <th>Qty</th> <th>UOM</th> </tr> </thead> <tbody> <tr> <td>VL1065A1</td> <td>1/4 MALE N.O. PRESSURE SWITCH</td> <td>1</td> <td>PZ</td> </tr> <tr> <td>VM1224A0</td> <td>65MY 220MM 2 COLOURS SHRINK TUBE</td> <td>0.150</td> <td>M</td> </tr> </tbody> </table>	Code	Description	Qty	UOM	VL1065A1	1/4 MALE N.O. PRESSURE SWITCH	1	PZ	VM1224A0	65MY 220MM 2 COLOURS SHRINK TUBE	0.150	M																
Code	Description	Qty	UOM																														
VL1065A1	1/4 MALE N.O. PRESSURE SWITCH	1	PZ																														
VM1224A0	65MY 220MM 2 COLOURS SHRINK TUBE	0.150	M																														
RC1356A	"STRAIGHT THREADED FEMALE END 8X1/4" BS		KRC1356A	STRAIGHT THREADED FEMALE END 8X1/4 BS	<table border="1"> <thead> <tr> <th>Code</th> <th>Description</th> <th>Qty</th> <th>UOM</th> </tr> </thead> <tbody> <tr> <td>RC1356A0</td> <td>"STRAIGHT THREADED FEMALE END 8X1/4" BS</td> <td>1</td> <td>PZ</td> </tr> <tr> <td>VM1224A0</td> <td>65MY 220MM 2 COLOURS SHRINK TUBE</td> <td>0.150</td> <td>M</td> </tr> </tbody> </table>	Code	Description	Qty	UOM	RC1356A0	"STRAIGHT THREADED FEMALE END 8X1/4" BS	1	PZ	VM1224A0	65MY 220MM 2 COLOURS SHRINK TUBE	0.150	M																
Code	Description	Qty	UOM																														
RC1356A0	"STRAIGHT THREADED FEMALE END 8X1/4" BS	1	PZ																														
VM1224A0	65MY 220MM 2 COLOURS SHRINK TUBE	0.150	M																														
RC1242A	D=10 CLOSED CAP		KRC1242A	Ø10 CLOSED CONNECTION 20PCS KIT	<table border="1"> <thead> <tr> <th>Code</th> <th>Description</th> <th>Qty</th> <th>UOM</th> </tr> </thead> <tbody> <tr> <td>RC1242A0</td> <td>D=10 CLOSED CAP</td> <td>20</td> <td>PZ</td> </tr> <tr> <td>VM1224A0</td> <td>65MY 220MM 2 COLOURS SHRINK TUBE</td> <td>0.200</td> <td>M</td> </tr> </tbody> </table>	Code	Description	Qty	UOM	RC1242A0	D=10 CLOSED CAP	20	PZ	VM1224A0	65MY 220MM 2 COLOURS SHRINK TUBE	0.200	M																
Code	Description	Qty	UOM																														
RC1242A0	D=10 CLOSED CAP	20	PZ																														
VM1224A0	65MY 220MM 2 COLOURS SHRINK TUBE	0.200	M																														
VL1174C	D1.2 MM CALIBRATED NOZZL		VL1174C0	D1.2 MM CALIBRATED NOZZL																													
VL1190A	PLUS WASHING SYSTEM INLET DISTRIBUTOR		KVL1209A	US PLUS 3 ROTOR ARMS WASHING SYSTEM KIT	<table border="1"> <thead> <tr> <th>Code</th> <th>Description</th> <th>Qty</th> <th>UOM</th> </tr> </thead> <tbody> <tr> <td>0H2354A0</td> <td>XEVC-XEVL WASHING CIRCUIT PLAT</td> <td>1</td> <td>PZ</td> </tr> <tr> <td>0H2411A0</td> <td></td> <td>1</td> <td>PZ</td> </tr> <tr> <td>EL1450A0</td> <td>US SELF-CLEANIN G WATER SOLENOID</td> <td>4</td> <td>PZ</td> </tr> <tr> <td>GN1526A0</td> <td>INT. D.=6.9 TH=1.8 O-RIN</td> <td>9</td> <td>PZ</td> </tr> <tr> <td>RC1018A0</td> <td>ZINC PLATED D12 ELASTIC CLAMP</td> <td>13</td> <td>PZ</td> </tr> <tr> <td>RC1019A0</td> <td>D=10 ELASTIC CLAMP</td> <td>15</td> <td>PZ</td> </tr> </tbody> </table>	Code	Description	Qty	UOM	0H2354A0	XEVC-XEVL WASHING CIRCUIT PLAT	1	PZ	0H2411A0		1	PZ	EL1450A0	US SELF-CLEANIN G WATER SOLENOID	4	PZ	GN1526A0	INT. D.=6.9 TH=1.8 O-RIN	9	PZ	RC1018A0	ZINC PLATED D12 ELASTIC CLAMP	13	PZ	RC1019A0	D=10 ELASTIC CLAMP	15	PZ
Code	Description	Qty	UOM																														
0H2354A0	XEVC-XEVL WASHING CIRCUIT PLAT	1	PZ																														
0H2411A0		1	PZ																														
EL1450A0	US SELF-CLEANIN G WATER SOLENOID	4	PZ																														
GN1526A0	INT. D.=6.9 TH=1.8 O-RIN	9	PZ																														
RC1018A0	ZINC PLATED D12 ELASTIC CLAMP	13	PZ																														
RC1019A0	D=10 ELASTIC CLAMP	15	PZ																														

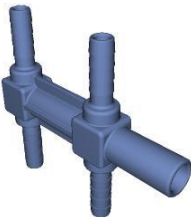

COMPONENT			SPARE PART																																																																																						
Code	Description	Image	Code	Description	Components list																																																																																				
VL1190A	PLUS WASHING SYSTEM INLET DISTRIBUTOR		KVL1209A	US PLUS 3 ROTOR ARMS WASHING SYSTEM KIT	<table border="1"> <thead> <tr> <th>Code</th> <th>Description</th> <th>Qty</th> <th>UOM</th> </tr> </thead> <tbody> <tr> <td>RC1130A0</td> <td>130X2,6 CLAM</td> <td>1</td> <td>PZ</td> </tr> <tr> <td>RC1131A0</td> <td>200X2,6 BLACK CLAMP</td> <td>3</td> <td>PZ</td> </tr> <tr> <td>RC1242A0</td> <td>D=10 CLOSED CAP</td> <td>2</td> <td>PZ</td> </tr> <tr> <td>RC1356A0</td> <td>"STRAIGHT THREADED FEMALE END 8X1/4" BS</td> <td>1</td> <td>PZ</td> </tr> <tr> <td>TB2820A0</td> <td>6X10 EPDM PIPE FOR WASHING SYSTEM</td> <td>2.750</td> <td>M</td> </tr> <tr> <td>TB3132A0</td> <td>WHITE-BLUE EPDM TEXTILE BRAID HOSE 6X12</td> <td>1.980</td> <td>M</td> </tr> <tr> <td>VI1220A1</td> <td>4,2X12 TCB SELF-TAPPIN G SCREW</td> <td>3</td> <td>PZ</td> </tr> <tr> <td>VL1019A0</td> <td>VIBRATION PUMP</td> <td>1</td> <td>PZ</td> </tr> <tr> <td>VL1065A1</td> <td>1/4 MALE N.O. PRESSURE SWITCH</td> <td>1</td> <td>PZ</td> </tr> <tr> <td>VL1102A1</td> <td>DETERGENT LINE FILTER + BARBED VNR 6 MM</td> <td>1</td> <td>PZ</td> </tr> <tr> <td>VL1127A1</td> <td>6MM BARBED T-SHAPED FITTING</td> <td>2</td> <td>PZ</td> </tr> <tr> <td>VL1128A1</td> <td>D6 BARBED CHECK VALVE</td> <td>3</td> <td>PZ</td> </tr> <tr> <td>VL1165A0</td> <td>BB6-AR6 STRAIGHT FITTING</td> <td>1</td> <td>PZ</td> </tr> <tr> <td>VL1166A0</td> <td>BB6-AR6 L FITTING</td> <td>4</td> <td>PZ</td> </tr> <tr> <td>VL1167A0</td> <td></td> <td>1</td> <td>PZ</td> </tr> <tr> <td>VL1167A1</td> <td></td> <td>1</td> <td>PZ</td> </tr> <tr> <td>VL1167A2</td> <td>GN21 3 ROTOR ARMS B-B FLOW RESTRICTOR</td> <td>1</td> <td>PZ</td> </tr> <tr> <td>VL1174C0</td> <td>D1.2 MM CALIBRATED NOZZLE</td> <td>1</td> <td>PZ</td> </tr> <tr> <td>VL1185A0</td> <td>2 WAYS PLUS WASHING DISTRIBUTOR</td> <td>1</td> <td>PZ</td> </tr> <tr> <td>VL1186A0</td> <td>3 WAYS PLUS WASHING DISTRIBUTOR</td> <td>1</td> <td>PZ</td> </tr> </tbody> </table>	Code	Description	Qty	UOM	RC1130A0	130X2,6 CLAM	1	PZ	RC1131A0	200X2,6 BLACK CLAMP	3	PZ	RC1242A0	D=10 CLOSED CAP	2	PZ	RC1356A0	"STRAIGHT THREADED FEMALE END 8X1/4" BS	1	PZ	TB2820A0	6X10 EPDM PIPE FOR WASHING SYSTEM	2.750	M	TB3132A0	WHITE-BLUE EPDM TEXTILE BRAID HOSE 6X12	1.980	M	VI1220A1	4,2X12 TCB SELF-TAPPIN G SCREW	3	PZ	VL1019A0	VIBRATION PUMP	1	PZ	VL1065A1	1/4 MALE N.O. PRESSURE SWITCH	1	PZ	VL1102A1	DETERGENT LINE FILTER + BARBED VNR 6 MM	1	PZ	VL1127A1	6MM BARBED T-SHAPED FITTING	2	PZ	VL1128A1	D6 BARBED CHECK VALVE	3	PZ	VL1165A0	BB6-AR6 STRAIGHT FITTING	1	PZ	VL1166A0	BB6-AR6 L FITTING	4	PZ	VL1167A0		1	PZ	VL1167A1		1	PZ	VL1167A2	GN21 3 ROTOR ARMS B-B FLOW RESTRICTOR	1	PZ	VL1174C0	D1.2 MM CALIBRATED NOZZLE	1	PZ	VL1185A0	2 WAYS PLUS WASHING DISTRIBUTOR	1	PZ	VL1186A0	3 WAYS PLUS WASHING DISTRIBUTOR	1	PZ
					Code	Description	Qty	UOM																																																																																	
					RC1130A0	130X2,6 CLAM	1	PZ																																																																																	
					RC1131A0	200X2,6 BLACK CLAMP	3	PZ																																																																																	
					RC1242A0	D=10 CLOSED CAP	2	PZ																																																																																	
					RC1356A0	"STRAIGHT THREADED FEMALE END 8X1/4" BS	1	PZ																																																																																	
					TB2820A0	6X10 EPDM PIPE FOR WASHING SYSTEM	2.750	M																																																																																	
					TB3132A0	WHITE-BLUE EPDM TEXTILE BRAID HOSE 6X12	1.980	M																																																																																	
					VI1220A1	4,2X12 TCB SELF-TAPPIN G SCREW	3	PZ																																																																																	
					VL1019A0	VIBRATION PUMP	1	PZ																																																																																	
					VL1065A1	1/4 MALE N.O. PRESSURE SWITCH	1	PZ																																																																																	
					VL1102A1	DETERGENT LINE FILTER + BARBED VNR 6 MM	1	PZ																																																																																	
					VL1127A1	6MM BARBED T-SHAPED FITTING	2	PZ																																																																																	
					VL1128A1	D6 BARBED CHECK VALVE	3	PZ																																																																																	
					VL1165A0	BB6-AR6 STRAIGHT FITTING	1	PZ																																																																																	
					VL1166A0	BB6-AR6 L FITTING	4	PZ																																																																																	
					VL1167A0		1	PZ																																																																																	
					VL1167A1		1	PZ																																																																																	
					VL1167A2	GN21 3 ROTOR ARMS B-B FLOW RESTRICTOR	1	PZ																																																																																	
					VL1174C0	D1.2 MM CALIBRATED NOZZLE	1	PZ																																																																																	
VL1185A0	2 WAYS PLUS WASHING DISTRIBUTOR	1	PZ																																																																																						
VL1186A0	3 WAYS PLUS WASHING DISTRIBUTOR	1	PZ																																																																																						

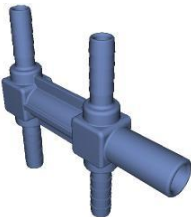

COMPONENT			SPARE PART																																																																			
Code	Description	Image	Code	Description	Components list																																																																	
VL1190A	PLUS WASHING SYSTEM INLET DISTRIBUTOR		KVL1209A	US PLUS 3 ROTOR ARMS WASHING SYSTEM KIT	<table border="1"> <thead> <tr> <th>Code</th> <th>Description</th> <th>Qty</th> <th>UOM</th> </tr> </thead> <tbody> <tr> <td>VL1190A0</td> <td>PLUS WASHING SYSTEM INLET DISTRIBUTOR</td> <td>1</td> <td>PZ</td> </tr> <tr> <td>VM1605A0</td> <td>CLIP TWIST LOCK DIAM. 10,2-12,7 MM</td> <td>6</td> <td>PZ</td> </tr> <tr> <td>VM2172A0</td> <td>PUMP-WITH-CI RCUIT LOCKING PIN</td> <td>9</td> <td>PZ</td> </tr> </tbody> </table>	Code	Description	Qty	UOM	VL1190A0	PLUS WASHING SYSTEM INLET DISTRIBUTOR	1	PZ	VM1605A0	CLIP TWIST LOCK DIAM. 10,2-12,7 MM	6	PZ	VM2172A0	PUMP-WITH-CI RCUIT LOCKING PIN	9	PZ																																																	
			Code	Description	Qty	UOM																																																																
VL1190A0	PLUS WASHING SYSTEM INLET DISTRIBUTOR	1	PZ																																																																			
VM1605A0	CLIP TWIST LOCK DIAM. 10,2-12,7 MM	6	PZ																																																																			
VM2172A0	PUMP-WITH-CI RCUIT LOCKING PIN	9	PZ																																																																			
KVL1208A	US PLUS 2 ROTOR ARMS WASHING SYSTEM KIT	<table border="1"> <thead> <tr> <th>Code</th> <th>Description</th> <th>Qty</th> <th>UOM</th> </tr> </thead> <tbody> <tr> <td>0H2354A0</td> <td>XEVC-XEVL WASHING CIRCUIT PLAT</td> <td>1</td> <td>PZ</td> </tr> <tr> <td>0H2411A0</td> <td></td> <td>1</td> <td>PZ</td> </tr> <tr> <td>EL1450A0</td> <td>US SELF-CLEANIN G WATER SOLENOID</td> <td>4</td> <td>PZ</td> </tr> <tr> <td>GN1526A0</td> <td>INT. D.=6.9 TH=1.8 O-RIN</td> <td>9</td> <td>PZ</td> </tr> <tr> <td>RC1018A0</td> <td>ZINC PLATED D12 ELASTIC CLAMP</td> <td>4</td> <td>PZ</td> </tr> <tr> <td>RC1019A0</td> <td>D=10 ELASTIC CLAMP</td> <td>16</td> <td>PZ</td> </tr> <tr> <td>RC1130A0</td> <td>130X2,6 CLAM</td> <td>1</td> <td>PZ</td> </tr> <tr> <td>RC1131A0</td> <td>200X2,6 BLACK CLAMP</td> <td>3</td> <td>PZ</td> </tr> <tr> <td>RC1242A0</td> <td>D=10 CLOSED CAP</td> <td>2</td> <td>PZ</td> </tr> <tr> <td>RC1356A0</td> <td>*STRAIGHT THREADED FEMALE END 8X1/4" BS</td> <td>1</td> <td>PZ</td> </tr> <tr> <td>TB2820A0</td> <td>6X10 EPDM PIPE FOR WASHING SYSTEM</td> <td>2.890</td> <td>M</td> </tr> <tr> <td>TB3132A0</td> <td>WHITE-BLUE EPDM TEXTILE BRAID HOSE 6X12</td> <td>1.600</td> <td>M</td> </tr> <tr> <td>V11220A1</td> <td>4,2X12 TCB SELF-TAPPIN G SCREW</td> <td>3</td> <td>PZ</td> </tr> <tr> <td>VL1019A0</td> <td>VIBRATION PUMP</td> <td>1</td> <td>PZ</td> </tr> <tr> <td>VL1047A1</td> <td>D6 PIPE HOLDER - D8 J.G. TERMINAL</td> <td>1</td> <td>PZ</td> </tr> <tr> <td>VL1065A1</td> <td>1/4 MALE N.O. PRESSURE SWITCH</td> <td>1</td> <td>PZ</td> </tr> </tbody> </table>	Code	Description	Qty	UOM	0H2354A0	XEVC-XEVL WASHING CIRCUIT PLAT	1	PZ	0H2411A0		1	PZ	EL1450A0	US SELF-CLEANIN G WATER SOLENOID	4	PZ	GN1526A0	INT. D.=6.9 TH=1.8 O-RIN	9	PZ	RC1018A0	ZINC PLATED D12 ELASTIC CLAMP	4	PZ	RC1019A0	D=10 ELASTIC CLAMP	16	PZ	RC1130A0	130X2,6 CLAM	1	PZ	RC1131A0	200X2,6 BLACK CLAMP	3	PZ	RC1242A0	D=10 CLOSED CAP	2	PZ	RC1356A0	*STRAIGHT THREADED FEMALE END 8X1/4" BS	1	PZ	TB2820A0	6X10 EPDM PIPE FOR WASHING SYSTEM	2.890	M	TB3132A0	WHITE-BLUE EPDM TEXTILE BRAID HOSE 6X12	1.600	M	V11220A1	4,2X12 TCB SELF-TAPPIN G SCREW	3	PZ	VL1019A0	VIBRATION PUMP	1	PZ	VL1047A1	D6 PIPE HOLDER - D8 J.G. TERMINAL	1	PZ	VL1065A1	1/4 MALE N.O. PRESSURE SWITCH	1	PZ
Code	Description	Qty	UOM																																																																			
0H2354A0	XEVC-XEVL WASHING CIRCUIT PLAT	1	PZ																																																																			
0H2411A0		1	PZ																																																																			
EL1450A0	US SELF-CLEANIN G WATER SOLENOID	4	PZ																																																																			
GN1526A0	INT. D.=6.9 TH=1.8 O-RIN	9	PZ																																																																			
RC1018A0	ZINC PLATED D12 ELASTIC CLAMP	4	PZ																																																																			
RC1019A0	D=10 ELASTIC CLAMP	16	PZ																																																																			
RC1130A0	130X2,6 CLAM	1	PZ																																																																			
RC1131A0	200X2,6 BLACK CLAMP	3	PZ																																																																			
RC1242A0	D=10 CLOSED CAP	2	PZ																																																																			
RC1356A0	*STRAIGHT THREADED FEMALE END 8X1/4" BS	1	PZ																																																																			
TB2820A0	6X10 EPDM PIPE FOR WASHING SYSTEM	2.890	M																																																																			
TB3132A0	WHITE-BLUE EPDM TEXTILE BRAID HOSE 6X12	1.600	M																																																																			
V11220A1	4,2X12 TCB SELF-TAPPIN G SCREW	3	PZ																																																																			
VL1019A0	VIBRATION PUMP	1	PZ																																																																			
VL1047A1	D6 PIPE HOLDER - D8 J.G. TERMINAL	1	PZ																																																																			
VL1065A1	1/4 MALE N.O. PRESSURE SWITCH	1	PZ																																																																			

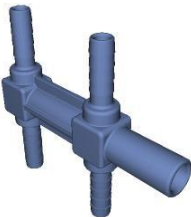

COMPONENT			SPARE PART																																														
Code	Description	Image	Code	Description	Components list																																												
VL1190A	PLUS WASHING SYSTEM INLET DISTRIBUTOR		KVL1208A	US PLUS 2 ROTOR ARMS WASHING SYSTEM KIT	<table border="1"> <thead> <tr> <th>Code</th> <th>Description</th> <th>Qty</th> <th>UOM</th> </tr> </thead> <tbody> <tr> <td>VL1102A1</td> <td>DETERGENT LINE FILTER + BARBED VNR 6 MM</td> <td>1</td> <td>PZ</td> </tr> <tr> <td>VL1128A1</td> <td>D6 BARBED CHECK VALVE</td> <td>2</td> <td>PZ</td> </tr> <tr> <td>VL1141A1</td> <td>STRAIGHT CONNECT BB6-BB6</td> <td>1</td> <td>PZ</td> </tr> <tr> <td>VL1165A0</td> <td>BB6-AR6 STRAIGHT FITTING</td> <td>1</td> <td>PZ</td> </tr> <tr> <td>VL1166A0</td> <td>BB6-AR6 L FITTING</td> <td>4</td> <td>PZ</td> </tr> <tr> <td>VL1174C0</td> <td>D1.2 MM CALIBRATED NOZZLE</td> <td>1</td> <td>PZ</td> </tr> <tr> <td>VL1186A0</td> <td>3 WAYS PLUS WASHING DISTRIBUTOR</td> <td>1</td> <td>PZ</td> </tr> <tr> <td>VL1190A0</td> <td>PLUS WASHING SYSTEM INLET DISTRIBUTOR</td> <td>1</td> <td>PZ</td> </tr> <tr> <td>VM1605A0</td> <td>CLIP TWIST LOCK DIAM. 10,2-12,7 MM</td> <td>6</td> <td>PZ</td> </tr> <tr> <td>VM2172A0</td> <td>PUMP-WITH-CIRCUIT LOCKING PIN</td> <td>9</td> <td>PZ</td> </tr> </tbody> </table>	Code	Description	Qty	UOM	VL1102A1	DETERGENT LINE FILTER + BARBED VNR 6 MM	1	PZ	VL1128A1	D6 BARBED CHECK VALVE	2	PZ	VL1141A1	STRAIGHT CONNECT BB6-BB6	1	PZ	VL1165A0	BB6-AR6 STRAIGHT FITTING	1	PZ	VL1166A0	BB6-AR6 L FITTING	4	PZ	VL1174C0	D1.2 MM CALIBRATED NOZZLE	1	PZ	VL1186A0	3 WAYS PLUS WASHING DISTRIBUTOR	1	PZ	VL1190A0	PLUS WASHING SYSTEM INLET DISTRIBUTOR	1	PZ	VM1605A0	CLIP TWIST LOCK DIAM. 10,2-12,7 MM	6	PZ	VM2172A0	PUMP-WITH-CIRCUIT LOCKING PIN	9	PZ
			Code	Description	Qty	UOM																																											
VL1102A1	DETERGENT LINE FILTER + BARBED VNR 6 MM	1	PZ																																														
VL1128A1	D6 BARBED CHECK VALVE	2	PZ																																														
VL1141A1	STRAIGHT CONNECT BB6-BB6	1	PZ																																														
VL1165A0	BB6-AR6 STRAIGHT FITTING	1	PZ																																														
VL1166A0	BB6-AR6 L FITTING	4	PZ																																														
VL1174C0	D1.2 MM CALIBRATED NOZZLE	1	PZ																																														
VL1186A0	3 WAYS PLUS WASHING DISTRIBUTOR	1	PZ																																														
VL1190A0	PLUS WASHING SYSTEM INLET DISTRIBUTOR	1	PZ																																														
VM1605A0	CLIP TWIST LOCK DIAM. 10,2-12,7 MM	6	PZ																																														
VM2172A0	PUMP-WITH-CIRCUIT LOCKING PIN	9	PZ																																														
KVL1207A	US PLUS 1 ROTOR ARM WASHING SYSTEM KIT	<table border="1"> <thead> <tr> <th>Code</th> <th>Description</th> <th>Qty</th> <th>UOM</th> </tr> </thead> <tbody> <tr> <td>0H2354A0</td> <td>XEVC-XEVL WASHING CIRCUIT PLAT</td> <td>1</td> <td>PZ</td> </tr> <tr> <td>0H2411A0</td> <td></td> <td>1</td> <td>PZ</td> </tr> <tr> <td>EL1450A0</td> <td>US SELF-CLEANING WATER SOLENOID</td> <td>3</td> <td>PZ</td> </tr> <tr> <td>GN1526A0</td> <td>INT. D.=6.9 TH=1.8 O-RING</td> <td>7</td> <td>PZ</td> </tr> <tr> <td>RC1018A0</td> <td>ZINC PLATED D12 ELASTIC CLAMP</td> <td>3</td> <td>PZ</td> </tr> <tr> <td>RC1019A0</td> <td>D=10 ELASTIC CLAMP</td> <td>14</td> <td>PZ</td> </tr> <tr> <td>RC1130A0</td> <td>130X2,6 CLAMP</td> <td>1</td> <td>PZ</td> </tr> <tr> <td>RC1131A0</td> <td>200X2,6 BLACK CLAMP</td> <td>2</td> <td>PZ</td> </tr> <tr> <td>RC1242A0</td> <td>D=10 CLOSED CAP</td> <td>2</td> <td>PZ</td> </tr> </tbody> </table>	Code	Description	Qty	UOM	0H2354A0	XEVC-XEVL WASHING CIRCUIT PLAT	1	PZ	0H2411A0		1	PZ	EL1450A0	US SELF-CLEANING WATER SOLENOID	3	PZ	GN1526A0	INT. D.=6.9 TH=1.8 O-RING	7	PZ	RC1018A0	ZINC PLATED D12 ELASTIC CLAMP	3	PZ	RC1019A0	D=10 ELASTIC CLAMP	14	PZ	RC1130A0	130X2,6 CLAMP	1	PZ	RC1131A0	200X2,6 BLACK CLAMP	2	PZ	RC1242A0	D=10 CLOSED CAP	2	PZ							
Code	Description	Qty	UOM																																														
0H2354A0	XEVC-XEVL WASHING CIRCUIT PLAT	1	PZ																																														
0H2411A0		1	PZ																																														
EL1450A0	US SELF-CLEANING WATER SOLENOID	3	PZ																																														
GN1526A0	INT. D.=6.9 TH=1.8 O-RING	7	PZ																																														
RC1018A0	ZINC PLATED D12 ELASTIC CLAMP	3	PZ																																														
RC1019A0	D=10 ELASTIC CLAMP	14	PZ																																														
RC1130A0	130X2,6 CLAMP	1	PZ																																														
RC1131A0	200X2,6 BLACK CLAMP	2	PZ																																														
RC1242A0	D=10 CLOSED CAP	2	PZ																																														

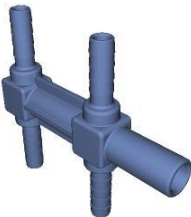

COMPONENT			SPARE PART																																																																						
Code	Description	Image	Code	Description	Components list																																																																				
VL1190A	PLUS WASHING SYSTEM INLET DISTRIBUTOR		KVL1207A	US PLUS 1 ROTOR ARM WASHING SYSTEM KIT	<table border="1"> <thead> <tr> <th>Code</th> <th>Description</th> <th>Qty</th> <th>UOM</th> </tr> </thead> <tbody> <tr> <td>RC1356A0</td> <td>"STRAIGHT THREADED FEMALE END 8X1/4" BS</td> <td>1</td> <td>PZ</td> </tr> <tr> <td>TB2820A0</td> <td>6X10 EPDM PIPE FOR WASHING SYSTEM</td> <td>1.460</td> <td>M</td> </tr> <tr> <td>TB3132A0</td> <td>WHITE-BLUE EPDM TEXTILE BRAID HOSE 6X12</td> <td>0.770</td> <td>M</td> </tr> <tr> <td>VI1220A1</td> <td>4,2X12 TCB SELF-TAPPIN G SCREW</td> <td>3</td> <td>PZ</td> </tr> <tr> <td>VL1019A0</td> <td>VIBRATION PUMP</td> <td>1</td> <td>PZ</td> </tr> <tr> <td>VL1047A1</td> <td>D6 PIPE HOLDER - D8 J.G. TERMINAL</td> <td>1</td> <td>PZ</td> </tr> <tr> <td>VL1065A1</td> <td>1/4 MALE N.O. PRESSURE SWITCH</td> <td>1</td> <td>PZ</td> </tr> <tr> <td>VL1102A1</td> <td>DETERGENT LINE FILTER + BARBED VNR 6 MM</td> <td>1</td> <td>PZ</td> </tr> <tr> <td>VL1128A1</td> <td>D6 BARBED CHECK VALVE</td> <td>2</td> <td>PZ</td> </tr> <tr> <td>VL1165A0</td> <td>BB6-AR6 STRAIGHT FITTING</td> <td>1</td> <td>PZ</td> </tr> <tr> <td>VL1166A0</td> <td>BB6-AR6 L FITTING</td> <td>3</td> <td>PZ</td> </tr> <tr> <td>VL1174C0</td> <td>D1.2 MM CALIBRATED NOZZLE</td> <td>1</td> <td>PZ</td> </tr> <tr> <td>VL1185A0</td> <td>2 WAYS PLUS WASHING DISTRIBUTOR</td> <td>1</td> <td>PZ</td> </tr> <tr> <td>VL1190A0</td> <td>PLUS WASHING SYSTEM INLET DISTRIBUTOR</td> <td>1</td> <td>PZ</td> </tr> <tr> <td>VM1605A0</td> <td>CLIP TWIST LOCK DIAM. 10,2-12,7 MM</td> <td>6</td> <td>PZ</td> </tr> <tr> <td>VM2172A0</td> <td>PUMP-WITH-CI RCUIT LOCKING PIN</td> <td>6</td> <td>PZ</td> </tr> </tbody> </table>	Code	Description	Qty	UOM	RC1356A0	"STRAIGHT THREADED FEMALE END 8X1/4" BS	1	PZ	TB2820A0	6X10 EPDM PIPE FOR WASHING SYSTEM	1.460	M	TB3132A0	WHITE-BLUE EPDM TEXTILE BRAID HOSE 6X12	0.770	M	VI1220A1	4,2X12 TCB SELF-TAPPIN G SCREW	3	PZ	VL1019A0	VIBRATION PUMP	1	PZ	VL1047A1	D6 PIPE HOLDER - D8 J.G. TERMINAL	1	PZ	VL1065A1	1/4 MALE N.O. PRESSURE SWITCH	1	PZ	VL1102A1	DETERGENT LINE FILTER + BARBED VNR 6 MM	1	PZ	VL1128A1	D6 BARBED CHECK VALVE	2	PZ	VL1165A0	BB6-AR6 STRAIGHT FITTING	1	PZ	VL1166A0	BB6-AR6 L FITTING	3	PZ	VL1174C0	D1.2 MM CALIBRATED NOZZLE	1	PZ	VL1185A0	2 WAYS PLUS WASHING DISTRIBUTOR	1	PZ	VL1190A0	PLUS WASHING SYSTEM INLET DISTRIBUTOR	1	PZ	VM1605A0	CLIP TWIST LOCK DIAM. 10,2-12,7 MM	6	PZ	VM2172A0	PUMP-WITH-CI RCUIT LOCKING PIN	6	PZ
Code	Description	Qty	UOM																																																																						
RC1356A0	"STRAIGHT THREADED FEMALE END 8X1/4" BS	1	PZ																																																																						
TB2820A0	6X10 EPDM PIPE FOR WASHING SYSTEM	1.460	M																																																																						
TB3132A0	WHITE-BLUE EPDM TEXTILE BRAID HOSE 6X12	0.770	M																																																																						
VI1220A1	4,2X12 TCB SELF-TAPPIN G SCREW	3	PZ																																																																						
VL1019A0	VIBRATION PUMP	1	PZ																																																																						
VL1047A1	D6 PIPE HOLDER - D8 J.G. TERMINAL	1	PZ																																																																						
VL1065A1	1/4 MALE N.O. PRESSURE SWITCH	1	PZ																																																																						
VL1102A1	DETERGENT LINE FILTER + BARBED VNR 6 MM	1	PZ																																																																						
VL1128A1	D6 BARBED CHECK VALVE	2	PZ																																																																						
VL1165A0	BB6-AR6 STRAIGHT FITTING	1	PZ																																																																						
VL1166A0	BB6-AR6 L FITTING	3	PZ																																																																						
VL1174C0	D1.2 MM CALIBRATED NOZZLE	1	PZ																																																																						
VL1185A0	2 WAYS PLUS WASHING DISTRIBUTOR	1	PZ																																																																						
VL1190A0	PLUS WASHING SYSTEM INLET DISTRIBUTOR	1	PZ																																																																						
VM1605A0	CLIP TWIST LOCK DIAM. 10,2-12,7 MM	6	PZ																																																																						
VM2172A0	PUMP-WITH-CI RCUIT LOCKING PIN	6	PZ																																																																						

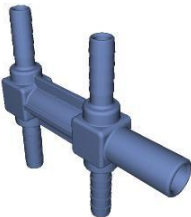
COMPONENT			SPARE PART																																																																																						
Code	Description	Image	Code	Description	Components list																																																																																				
VL1190A	PLUS WASHING SYSTEM INLET DISTRIBUTOR		KVL1187A	3 ROTOR ARMS PLUS EU CLEANING SYSTEM KIT	<table border="1"> <thead> <tr> <th>Code</th> <th>Description</th> <th>Qty</th> <th>UOM</th> </tr> </thead> <tbody> <tr> <td>0H2143A0</td> <td>LAMIERA BLOCCA VNR VL1128</td> <td>3</td> <td>PZ</td> </tr> <tr> <td>0H2168A0</td> <td></td> <td>1</td> <td>PZ</td> </tr> <tr> <td>0H2354A0</td> <td>XEVC-XEVL WASHING CIRCUIT PLAT</td> <td>1</td> <td>PZ</td> </tr> <tr> <td>EL1120A0</td> <td>D8-D6 FEMALE STRAIGHT INTERM. CONNECTION</td> <td>1</td> <td>PZ</td> </tr> <tr> <td>EL1220A0</td> <td>JG STRAIGHT CONNECTION Ø8F-Ø8F</td> <td>2</td> <td>PZ</td> </tr> <tr> <td>EL1440A0</td> <td>WATER SELF CLEANING VALVE</td> <td>4</td> <td>PZ</td> </tr> <tr> <td>GN1526A0</td> <td>INT. D.=6.9 TH=1.8 O-RIN</td> <td>9</td> <td>PZ</td> </tr> <tr> <td>RC1018A0</td> <td>ZINC PLATED D12 ELASTIC CLAMP</td> <td>10</td> <td>PZ</td> </tr> <tr> <td>RC1019A0</td> <td>D=10 ELASTIC CLAMP</td> <td>22</td> <td>PZ</td> </tr> <tr> <td>RC1130A0</td> <td>130X2,6 CLAM</td> <td>4</td> <td>PZ</td> </tr> <tr> <td>RC1131A0</td> <td>200X2.6 BLACK CLAMP</td> <td>3</td> <td>PZ</td> </tr> <tr> <td>RC1242A0</td> <td>D=10 CLOSED CAP</td> <td>2</td> <td>PZ</td> </tr> <tr> <td>RC1310A0</td> <td>140X4 CLAMP WITH CLIP</td> <td>1</td> <td>PZ</td> </tr> <tr> <td>RC1356A0</td> <td>"STRAIGHT THREADED FEMALE END 8X1/4" BS</td> <td>1</td> <td>PZ</td> </tr> <tr> <td>TB2820A0</td> <td>6X10 EPDM PIPE FOR WASHING SYSTEM</td> <td>1.510</td> <td>M</td> </tr> <tr> <td>TB3132A0</td> <td>WHITE-BLUE EPDM TEXTILE BRAID HOSE 6X12</td> <td>1.210</td> <td>M</td> </tr> <tr> <td>VH1220A1</td> <td>4,2X12 TCB SELF-TAPPIN G SCREW</td> <td>3</td> <td>PZ</td> </tr> <tr> <td>VL1019A0</td> <td>VIBRATION PUMP</td> <td>1</td> <td>PZ</td> </tr> <tr> <td>VL1046A1</td> <td>D6 PIPE HOLDER - D6 J.G. TERMINAL</td> <td>3</td> <td>PZ</td> </tr> <tr> <td>VL1047A1</td> <td>D6 PIPE HOLDER - D8 J.G. TERMINAL</td> <td>1</td> <td>PZ</td> </tr> </tbody> </table>	Code	Description	Qty	UOM	0H2143A0	LAMIERA BLOCCA VNR VL1128	3	PZ	0H2168A0		1	PZ	0H2354A0	XEVC-XEVL WASHING CIRCUIT PLAT	1	PZ	EL1120A0	D8-D6 FEMALE STRAIGHT INTERM. CONNECTION	1	PZ	EL1220A0	JG STRAIGHT CONNECTION Ø8F-Ø8F	2	PZ	EL1440A0	WATER SELF CLEANING VALVE	4	PZ	GN1526A0	INT. D.=6.9 TH=1.8 O-RIN	9	PZ	RC1018A0	ZINC PLATED D12 ELASTIC CLAMP	10	PZ	RC1019A0	D=10 ELASTIC CLAMP	22	PZ	RC1130A0	130X2,6 CLAM	4	PZ	RC1131A0	200X2.6 BLACK CLAMP	3	PZ	RC1242A0	D=10 CLOSED CAP	2	PZ	RC1310A0	140X4 CLAMP WITH CLIP	1	PZ	RC1356A0	"STRAIGHT THREADED FEMALE END 8X1/4" BS	1	PZ	TB2820A0	6X10 EPDM PIPE FOR WASHING SYSTEM	1.510	M	TB3132A0	WHITE-BLUE EPDM TEXTILE BRAID HOSE 6X12	1.210	M	VH1220A1	4,2X12 TCB SELF-TAPPIN G SCREW	3	PZ	VL1019A0	VIBRATION PUMP	1	PZ	VL1046A1	D6 PIPE HOLDER - D6 J.G. TERMINAL	3	PZ	VL1047A1	D6 PIPE HOLDER - D8 J.G. TERMINAL	1	PZ
Code	Description	Qty	UOM																																																																																						
0H2143A0	LAMIERA BLOCCA VNR VL1128	3	PZ																																																																																						
0H2168A0		1	PZ																																																																																						
0H2354A0	XEVC-XEVL WASHING CIRCUIT PLAT	1	PZ																																																																																						
EL1120A0	D8-D6 FEMALE STRAIGHT INTERM. CONNECTION	1	PZ																																																																																						
EL1220A0	JG STRAIGHT CONNECTION Ø8F-Ø8F	2	PZ																																																																																						
EL1440A0	WATER SELF CLEANING VALVE	4	PZ																																																																																						
GN1526A0	INT. D.=6.9 TH=1.8 O-RIN	9	PZ																																																																																						
RC1018A0	ZINC PLATED D12 ELASTIC CLAMP	10	PZ																																																																																						
RC1019A0	D=10 ELASTIC CLAMP	22	PZ																																																																																						
RC1130A0	130X2,6 CLAM	4	PZ																																																																																						
RC1131A0	200X2.6 BLACK CLAMP	3	PZ																																																																																						
RC1242A0	D=10 CLOSED CAP	2	PZ																																																																																						
RC1310A0	140X4 CLAMP WITH CLIP	1	PZ																																																																																						
RC1356A0	"STRAIGHT THREADED FEMALE END 8X1/4" BS	1	PZ																																																																																						
TB2820A0	6X10 EPDM PIPE FOR WASHING SYSTEM	1.510	M																																																																																						
TB3132A0	WHITE-BLUE EPDM TEXTILE BRAID HOSE 6X12	1.210	M																																																																																						
VH1220A1	4,2X12 TCB SELF-TAPPIN G SCREW	3	PZ																																																																																						
VL1019A0	VIBRATION PUMP	1	PZ																																																																																						
VL1046A1	D6 PIPE HOLDER - D6 J.G. TERMINAL	3	PZ																																																																																						
VL1047A1	D6 PIPE HOLDER - D8 J.G. TERMINAL	1	PZ																																																																																						

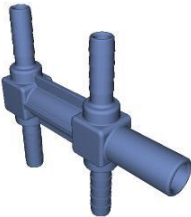

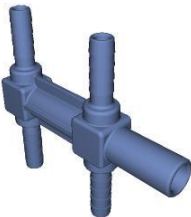
COMPONENT			SPARE PART																																																																																		
Code	Description	Image	Code	Description	Components list																																																																																
VL1190A	PLUS WASHING SYSTEM INLET DISTRIBUTOR		KVL1187A	3 ROTOR ARMS PLUS EU CLEANING SYSTEM KIT	<table border="1"> <thead> <tr> <th>Code</th> <th>Description</th> <th>Qty</th> <th>UOM</th> </tr> </thead> <tbody> <tr> <td>VL1064A0</td> <td>WASHING SYSTEM OUTLETS DISTRIBUTOR</td> <td>1</td> <td>PZ</td> </tr> <tr> <td>VL1065A1</td> <td>1/4 MALE N.O. PRESSURE SWITCH</td> <td>1</td> <td>PZ</td> </tr> <tr> <td>VL1067A0</td> <td>WASHING SYSTEM INLETS DISTRIBUTOR</td> <td>1</td> <td>PZ</td> </tr> <tr> <td>VL1092A0</td> <td>WASHING SYSTEM OUTLET DOUBLE DISTRIBUTOR</td> <td>1</td> <td>PZ</td> </tr> <tr> <td>VL1102A1</td> <td>DETERGENT LINE FILTER + BARBED VNR 6 MM</td> <td>1</td> <td>PZ</td> </tr> <tr> <td>VL1127A1</td> <td>6MM BARBED T-SHAPED FITTING</td> <td>2</td> <td>PZ</td> </tr> <tr> <td>VL1128A0</td> <td>D6 BARBED CHECK VALVE</td> <td>3</td> <td>PZ</td> </tr> <tr> <td>VL1128A1</td> <td>D6 BARBED CHECK VALVE</td> <td>3</td> <td>PZ</td> </tr> <tr> <td>VL1165A0</td> <td>BB6-AR6 STRAIGHT FITTING</td> <td>4</td> <td>PZ</td> </tr> <tr> <td>VL1166A0</td> <td>BB6-AR6 L FITTING</td> <td>4</td> <td>PZ</td> </tr> <tr> <td>VL1167A0</td> <td></td> <td>1</td> <td>PZ</td> </tr> <tr> <td>VL1167A1</td> <td></td> <td>1</td> <td>PZ</td> </tr> <tr> <td>VL1167A2</td> <td>GN21 3 ROTOR ARMS B-B FLOW RESTRICTOR</td> <td>1</td> <td>PZ</td> </tr> <tr> <td>VL1174C0</td> <td>D1.2 MM CALIBRATED NOZZLE</td> <td>1</td> <td>PZ</td> </tr> <tr> <td>VL1185A0</td> <td>2 WAYS PLUS WASHING DISTRIBUTOR</td> <td>1</td> <td>PZ</td> </tr> <tr> <td>VL1186A0</td> <td>3 WAYS PLUS WASHING DISTRIBUTOR</td> <td>1</td> <td>PZ</td> </tr> <tr> <td>VL1190A0</td> <td>PLUS WASHING SYSTEM INLET DISTRIBUTOR</td> <td>1</td> <td>PZ</td> </tr> <tr> <td>VM1605A0</td> <td>CLIP TWIST LOCK DIAM. 10.2-12.7 MM</td> <td>3</td> <td>PZ</td> </tr> <tr> <td>VM2172A0</td> <td>PUMP-WITH-CI RCUIT LOCKING PIN</td> <td>9</td> <td>PZ</td> </tr> </tbody> </table>	Code	Description	Qty	UOM	VL1064A0	WASHING SYSTEM OUTLETS DISTRIBUTOR	1	PZ	VL1065A1	1/4 MALE N.O. PRESSURE SWITCH	1	PZ	VL1067A0	WASHING SYSTEM INLETS DISTRIBUTOR	1	PZ	VL1092A0	WASHING SYSTEM OUTLET DOUBLE DISTRIBUTOR	1	PZ	VL1102A1	DETERGENT LINE FILTER + BARBED VNR 6 MM	1	PZ	VL1127A1	6MM BARBED T-SHAPED FITTING	2	PZ	VL1128A0	D6 BARBED CHECK VALVE	3	PZ	VL1128A1	D6 BARBED CHECK VALVE	3	PZ	VL1165A0	BB6-AR6 STRAIGHT FITTING	4	PZ	VL1166A0	BB6-AR6 L FITTING	4	PZ	VL1167A0		1	PZ	VL1167A1		1	PZ	VL1167A2	GN21 3 ROTOR ARMS B-B FLOW RESTRICTOR	1	PZ	VL1174C0	D1.2 MM CALIBRATED NOZZLE	1	PZ	VL1185A0	2 WAYS PLUS WASHING DISTRIBUTOR	1	PZ	VL1186A0	3 WAYS PLUS WASHING DISTRIBUTOR	1	PZ	VL1190A0	PLUS WASHING SYSTEM INLET DISTRIBUTOR	1	PZ	VM1605A0	CLIP TWIST LOCK DIAM. 10.2-12.7 MM	3	PZ	VM2172A0	PUMP-WITH-CI RCUIT LOCKING PIN	9	PZ
Code	Description	Qty	UOM																																																																																		
VL1064A0	WASHING SYSTEM OUTLETS DISTRIBUTOR	1	PZ																																																																																		
VL1065A1	1/4 MALE N.O. PRESSURE SWITCH	1	PZ																																																																																		
VL1067A0	WASHING SYSTEM INLETS DISTRIBUTOR	1	PZ																																																																																		
VL1092A0	WASHING SYSTEM OUTLET DOUBLE DISTRIBUTOR	1	PZ																																																																																		
VL1102A1	DETERGENT LINE FILTER + BARBED VNR 6 MM	1	PZ																																																																																		
VL1127A1	6MM BARBED T-SHAPED FITTING	2	PZ																																																																																		
VL1128A0	D6 BARBED CHECK VALVE	3	PZ																																																																																		
VL1128A1	D6 BARBED CHECK VALVE	3	PZ																																																																																		
VL1165A0	BB6-AR6 STRAIGHT FITTING	4	PZ																																																																																		
VL1166A0	BB6-AR6 L FITTING	4	PZ																																																																																		
VL1167A0		1	PZ																																																																																		
VL1167A1		1	PZ																																																																																		
VL1167A2	GN21 3 ROTOR ARMS B-B FLOW RESTRICTOR	1	PZ																																																																																		
VL1174C0	D1.2 MM CALIBRATED NOZZLE	1	PZ																																																																																		
VL1185A0	2 WAYS PLUS WASHING DISTRIBUTOR	1	PZ																																																																																		
VL1186A0	3 WAYS PLUS WASHING DISTRIBUTOR	1	PZ																																																																																		
VL1190A0	PLUS WASHING SYSTEM INLET DISTRIBUTOR	1	PZ																																																																																		
VM1605A0	CLIP TWIST LOCK DIAM. 10.2-12.7 MM	3	PZ																																																																																		
VM2172A0	PUMP-WITH-CI RCUIT LOCKING PIN	9	PZ																																																																																		

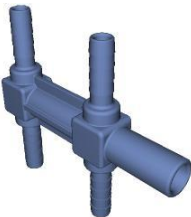
COMPONENT			SPARE PART																																																																																		
Code	Description	Image	Code	Description	Components list																																																																																
VL1190A	PLUS WASHING SYSTEM INLET DISTRIBUTOR		KVL1184A	2 ROTOR ARMS PLUS EU CLEANING SYSTEM KIT	<table border="1"> <thead> <tr> <th>Code</th> <th>Description</th> <th>Qty</th> <th>UOM</th> </tr> </thead> <tbody> <tr> <td>0H2143A0</td> <td>LAMIERA BLOCCA VNR VL1128</td> <td>2</td> <td>PZ</td> </tr> <tr> <td>0H2168A0</td> <td></td> <td>1</td> <td>PZ</td> </tr> <tr> <td>0H2354A0</td> <td>XEVC-XEVL WASHING CIRCUIT PLAT</td> <td>1</td> <td>PZ</td> </tr> <tr> <td>EL1220A0</td> <td>JG STRAIGHT CONNECTION Ø8F-Ø8F</td> <td>3</td> <td>PZ</td> </tr> <tr> <td>EL1440A0</td> <td>WATER SELF CLEANING VALVE</td> <td>4</td> <td>PZ</td> </tr> <tr> <td>GN1526A0</td> <td>INT. D.=6.9 TH=1.8 O-RIN</td> <td>9</td> <td>PZ</td> </tr> <tr> <td>RC1018A0</td> <td>ZINC PLATED D12 ELASTIC CLAMP</td> <td>2</td> <td>PZ</td> </tr> <tr> <td>RC1019A0</td> <td>D=10 ELASTIC CLAMP</td> <td>21</td> <td>PZ</td> </tr> <tr> <td>RC1130A0</td> <td>130X2,6 CLAM</td> <td>7</td> <td>PZ</td> </tr> <tr> <td>RC1131A0</td> <td>200X2.6 BLACK CLAMP</td> <td>3</td> <td>PZ</td> </tr> <tr> <td>RC1242A0</td> <td>D=10 CLOSED CAP</td> <td>2</td> <td>PZ</td> </tr> <tr> <td>RC1356A0</td> <td>"STRAIGHT THREADED FEMALE END 8X1/4" BS</td> <td>1</td> <td>PZ</td> </tr> <tr> <td>TB2820A0</td> <td>6X10 EPDM PIPE FOR WASHING SYSTEM</td> <td>2.400</td> <td>M</td> </tr> <tr> <td>TB3132A0</td> <td>WHITE-BLUE EPDM TEXTILE BRAID HOSE 6X12</td> <td>1.220</td> <td>M</td> </tr> <tr> <td>VL1019A0</td> <td>VIBRATION PUMP</td> <td>1</td> <td>PZ</td> </tr> <tr> <td>VL1046A1</td> <td>D6 PIPE HOLDER - D6 J.G. TERMINAL</td> <td>3</td> <td>PZ</td> </tr> <tr> <td>VL1047A1</td> <td>D6 PIPE HOLDER - D8 J.G. TERMINAL</td> <td>1</td> <td>PZ</td> </tr> <tr> <td>VL1065A1</td> <td>1/4 MALE N.O. PRESSURE SWITCH</td> <td>1</td> <td>PZ</td> </tr> <tr> <td>VL1067A0</td> <td>WASHING SYSTEM INLETS DISTRIBUTOR</td> <td>1</td> <td>PZ</td> </tr> </tbody> </table>	Code	Description	Qty	UOM	0H2143A0	LAMIERA BLOCCA VNR VL1128	2	PZ	0H2168A0		1	PZ	0H2354A0	XEVC-XEVL WASHING CIRCUIT PLAT	1	PZ	EL1220A0	JG STRAIGHT CONNECTION Ø8F-Ø8F	3	PZ	EL1440A0	WATER SELF CLEANING VALVE	4	PZ	GN1526A0	INT. D.=6.9 TH=1.8 O-RIN	9	PZ	RC1018A0	ZINC PLATED D12 ELASTIC CLAMP	2	PZ	RC1019A0	D=10 ELASTIC CLAMP	21	PZ	RC1130A0	130X2,6 CLAM	7	PZ	RC1131A0	200X2.6 BLACK CLAMP	3	PZ	RC1242A0	D=10 CLOSED CAP	2	PZ	RC1356A0	"STRAIGHT THREADED FEMALE END 8X1/4" BS	1	PZ	TB2820A0	6X10 EPDM PIPE FOR WASHING SYSTEM	2.400	M	TB3132A0	WHITE-BLUE EPDM TEXTILE BRAID HOSE 6X12	1.220	M	VL1019A0	VIBRATION PUMP	1	PZ	VL1046A1	D6 PIPE HOLDER - D6 J.G. TERMINAL	3	PZ	VL1047A1	D6 PIPE HOLDER - D8 J.G. TERMINAL	1	PZ	VL1065A1	1/4 MALE N.O. PRESSURE SWITCH	1	PZ	VL1067A0	WASHING SYSTEM INLETS DISTRIBUTOR	1	PZ
Code	Description	Qty	UOM																																																																																		
0H2143A0	LAMIERA BLOCCA VNR VL1128	2	PZ																																																																																		
0H2168A0		1	PZ																																																																																		
0H2354A0	XEVC-XEVL WASHING CIRCUIT PLAT	1	PZ																																																																																		
EL1220A0	JG STRAIGHT CONNECTION Ø8F-Ø8F	3	PZ																																																																																		
EL1440A0	WATER SELF CLEANING VALVE	4	PZ																																																																																		
GN1526A0	INT. D.=6.9 TH=1.8 O-RIN	9	PZ																																																																																		
RC1018A0	ZINC PLATED D12 ELASTIC CLAMP	2	PZ																																																																																		
RC1019A0	D=10 ELASTIC CLAMP	21	PZ																																																																																		
RC1130A0	130X2,6 CLAM	7	PZ																																																																																		
RC1131A0	200X2.6 BLACK CLAMP	3	PZ																																																																																		
RC1242A0	D=10 CLOSED CAP	2	PZ																																																																																		
RC1356A0	"STRAIGHT THREADED FEMALE END 8X1/4" BS	1	PZ																																																																																		
TB2820A0	6X10 EPDM PIPE FOR WASHING SYSTEM	2.400	M																																																																																		
TB3132A0	WHITE-BLUE EPDM TEXTILE BRAID HOSE 6X12	1.220	M																																																																																		
VL1019A0	VIBRATION PUMP	1	PZ																																																																																		
VL1046A1	D6 PIPE HOLDER - D6 J.G. TERMINAL	3	PZ																																																																																		
VL1047A1	D6 PIPE HOLDER - D8 J.G. TERMINAL	1	PZ																																																																																		
VL1065A1	1/4 MALE N.O. PRESSURE SWITCH	1	PZ																																																																																		
VL1067A0	WASHING SYSTEM INLETS DISTRIBUTOR	1	PZ																																																																																		

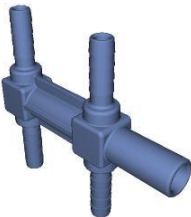
COMPONENT			SPARE PART																																																																																					
Code	Description	Image	Code	Description	Components list																																																																																			
VL1190A	PLUS WASHING SYSTEM INLET DISTRIBUTOR		KVL1184A	2 ROTOR ARMS PLUS EU CLEANING SYSTEM KIT	<table border="1"> <thead> <tr> <th>Code</th> <th>Description</th> <th>Qty</th> <th>UOM</th> </tr> </thead> <tbody> <tr> <td>VL1092A0</td> <td>WASHING SYSTEM OUTLET DOUBLE DISTRIBUTOR</td> <td>1</td> <td>PZ</td> </tr> <tr> <td>VL1102A1</td> <td>DETERGENT LINE FILTER + BARBED VNR 6 MM</td> <td>1</td> <td>PZ</td> </tr> <tr> <td>VL1128A0</td> <td>D6 BARBED CHECK VALVE</td> <td>2</td> <td>PZ</td> </tr> <tr> <td>VL1128A1</td> <td>D6 BARBED CHECK VALVE</td> <td>2</td> <td>PZ</td> </tr> <tr> <td>VL1141A1</td> <td>STRAIGHT CONNECT BB6-BB6</td> <td>1</td> <td>PZ</td> </tr> <tr> <td>VL1165A0</td> <td>BB6-AR6 STRAIGHT FITTING</td> <td>4</td> <td>PZ</td> </tr> <tr> <td>VL1166A0</td> <td>BB6-AR6 L FITTING</td> <td>4</td> <td>PZ</td> </tr> <tr> <td>VL1174C0</td> <td>D1.2 MM CALIBRATED NOZZLE</td> <td>1</td> <td>PZ</td> </tr> <tr> <td>VL1186A0</td> <td>3 WAYS PLUS WASHING DISTRIBUTOR</td> <td>1</td> <td>PZ</td> </tr> <tr> <td>VL1190A0</td> <td>PLUS WASHING SYSTEM INLET DISTRIBUTOR</td> <td>1</td> <td>PZ</td> </tr> <tr> <td>VM1605A0</td> <td>CLIP TWIST LOCK DIAM. 10,2-12,7 MM</td> <td>4</td> <td>PZ</td> </tr> <tr> <td>VM2172A0</td> <td>PUMP-WITH-CI RCUIT LOCKING PIN</td> <td>9</td> <td>PZ</td> </tr> </tbody> </table>	Code	Description	Qty	UOM	VL1092A0	WASHING SYSTEM OUTLET DOUBLE DISTRIBUTOR	1	PZ	VL1102A1	DETERGENT LINE FILTER + BARBED VNR 6 MM	1	PZ	VL1128A0	D6 BARBED CHECK VALVE	2	PZ	VL1128A1	D6 BARBED CHECK VALVE	2	PZ	VL1141A1	STRAIGHT CONNECT BB6-BB6	1	PZ	VL1165A0	BB6-AR6 STRAIGHT FITTING	4	PZ	VL1166A0	BB6-AR6 L FITTING	4	PZ	VL1174C0	D1.2 MM CALIBRATED NOZZLE	1	PZ	VL1186A0	3 WAYS PLUS WASHING DISTRIBUTOR	1	PZ	VL1190A0	PLUS WASHING SYSTEM INLET DISTRIBUTOR	1	PZ	VM1605A0	CLIP TWIST LOCK DIAM. 10,2-12,7 MM	4	PZ	VM2172A0	PUMP-WITH-CI RCUIT LOCKING PIN	9	PZ	KVL1183A	1 ROTOR ARM PLUS CLEANING SYSTEM KIT	<table border="1"> <thead> <tr> <th>Code</th> <th>Description</th> <th>Qty</th> <th>UOM</th> </tr> </thead> <tbody> <tr> <td>0H2143A0</td> <td>LAMIERA BLOCCA VNR VL1128</td> <td>2</td> <td>PZ</td> </tr> <tr> <td>0H2168A1</td> <td></td> <td>1</td> <td>PZ</td> </tr> <tr> <td>0H2354A0</td> <td>XEVC-XEVL WASHING CIRCUIT PLAT</td> <td>1</td> <td>PZ</td> </tr> <tr> <td>EL1440A0</td> <td>WATER SELF CLEANING VALVE</td> <td>3</td> <td>PZ</td> </tr> <tr> <td>GN1526A0</td> <td>INT. D.=6.9 TH=1.8 O-RIN</td> <td>7</td> <td>PZ</td> </tr> <tr> <td>RC1018A0</td> <td>ZINC PLATED D12 ELASTIC CLAMP</td> <td>2</td> <td>PZ</td> </tr> </tbody> </table>	Code	Description	Qty	UOM	0H2143A0	LAMIERA BLOCCA VNR VL1128	2	PZ	0H2168A1		1	PZ	0H2354A0	XEVC-XEVL WASHING CIRCUIT PLAT	1	PZ	EL1440A0	WATER SELF CLEANING VALVE	3	PZ	GN1526A0	INT. D.=6.9 TH=1.8 O-RIN	7	PZ	RC1018A0	ZINC PLATED D12 ELASTIC CLAMP	2	PZ
			Code	Description	Qty	UOM																																																																																		
VL1092A0	WASHING SYSTEM OUTLET DOUBLE DISTRIBUTOR	1	PZ																																																																																					
VL1102A1	DETERGENT LINE FILTER + BARBED VNR 6 MM	1	PZ																																																																																					
VL1128A0	D6 BARBED CHECK VALVE	2	PZ																																																																																					
VL1128A1	D6 BARBED CHECK VALVE	2	PZ																																																																																					
VL1141A1	STRAIGHT CONNECT BB6-BB6	1	PZ																																																																																					
VL1165A0	BB6-AR6 STRAIGHT FITTING	4	PZ																																																																																					
VL1166A0	BB6-AR6 L FITTING	4	PZ																																																																																					
VL1174C0	D1.2 MM CALIBRATED NOZZLE	1	PZ																																																																																					
VL1186A0	3 WAYS PLUS WASHING DISTRIBUTOR	1	PZ																																																																																					
VL1190A0	PLUS WASHING SYSTEM INLET DISTRIBUTOR	1	PZ																																																																																					
VM1605A0	CLIP TWIST LOCK DIAM. 10,2-12,7 MM	4	PZ																																																																																					
VM2172A0	PUMP-WITH-CI RCUIT LOCKING PIN	9	PZ																																																																																					
Code	Description	Qty	UOM																																																																																					
0H2143A0	LAMIERA BLOCCA VNR VL1128	2	PZ																																																																																					
0H2168A1		1	PZ																																																																																					
0H2354A0	XEVC-XEVL WASHING CIRCUIT PLAT	1	PZ																																																																																					
EL1440A0	WATER SELF CLEANING VALVE	3	PZ																																																																																					
GN1526A0	INT. D.=6.9 TH=1.8 O-RIN	7	PZ																																																																																					
RC1018A0	ZINC PLATED D12 ELASTIC CLAMP	2	PZ																																																																																					

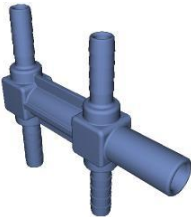
COMPONENT			SPARE PART																																																																																		
Code	Description	Image	Code	Description	Components list																																																																																
VL1190A	PLUS WASHING SYSTEM INLET DISTRIBUTOR		KVL1183A	1 ROTOR ARM PLUS CLEANING SYSTEM KIT	<table border="1"> <thead> <tr> <th>Code</th> <th>Description</th> <th>Qty</th> <th>UOM</th> </tr> </thead> <tbody> <tr> <td>RC1019A0</td> <td>D=10 ELASTIC CLAMP</td> <td>14</td> <td>PZ</td> </tr> <tr> <td>RC1130A0</td> <td>130X2,6 CLAM</td> <td>5</td> <td>PZ</td> </tr> <tr> <td>RC1131A0</td> <td>200X2.6 BLACK CLAMP</td> <td>2</td> <td>PZ</td> </tr> <tr> <td>RC1242A0</td> <td>D=10 CLOSED CAP</td> <td>2</td> <td>PZ</td> </tr> <tr> <td>RC1356A0</td> <td>"STRAIGHT THREADED FEMALE END 8X1/4" BS</td> <td>1</td> <td>PZ</td> </tr> <tr> <td>TB2820A0</td> <td>6X10 EPDM PIPE FOR WASHING SYSTEM</td> <td>1.410</td> <td>M</td> </tr> <tr> <td>TB3132A0</td> <td>WHITE-BLUE EPDM TEXTILE BRAID HOSE 6X12</td> <td>0.770</td> <td>M</td> </tr> <tr> <td>VI1220A1</td> <td>4,2X12 TCB SELF-TAPPING SCREW</td> <td>3</td> <td>PZ</td> </tr> <tr> <td>VL1019A0</td> <td>VIBRATION PUMP</td> <td>1</td> <td>PZ</td> </tr> <tr> <td>VL1047A1</td> <td>D6 PIPE HOLDER - D8 J.G. TERMINAL</td> <td>1</td> <td>PZ</td> </tr> <tr> <td>VL1065A1</td> <td>1/4 MALE N.O. PRESSURE SWITCH</td> <td>1</td> <td>PZ</td> </tr> <tr> <td>VL1102A1</td> <td>DETERGENT LINE FILTER + BARBED VNR 6 MM</td> <td>1</td> <td>PZ</td> </tr> <tr> <td>VL1128A0</td> <td>D6 BARBED CHECK VALVE</td> <td>2</td> <td>PZ</td> </tr> <tr> <td>VL1128A1</td> <td>D6 BARBED CHECK VALVE</td> <td>2</td> <td>PZ</td> </tr> <tr> <td>VL1165A0</td> <td>BB6-AR6 STRAIGHT FITTING</td> <td>1</td> <td>PZ</td> </tr> <tr> <td>VL1166A0</td> <td>BB6-AR6 L FITTING</td> <td>3</td> <td>PZ</td> </tr> <tr> <td>VL1174C0</td> <td>D1.2 MM CALIBRATED NOZZLE</td> <td>1</td> <td>PZ</td> </tr> <tr> <td>VL1185A0</td> <td>2 WAYS PLUS WASHING DISTRIBUTOR</td> <td>1</td> <td>PZ</td> </tr> <tr> <td>VL1190A0</td> <td>PLUS WASHING SYSTEM INLET DISTRIBUTOR</td> <td>1</td> <td>PZ</td> </tr> </tbody> </table>	Code	Description	Qty	UOM	RC1019A0	D=10 ELASTIC CLAMP	14	PZ	RC1130A0	130X2,6 CLAM	5	PZ	RC1131A0	200X2.6 BLACK CLAMP	2	PZ	RC1242A0	D=10 CLOSED CAP	2	PZ	RC1356A0	"STRAIGHT THREADED FEMALE END 8X1/4" BS	1	PZ	TB2820A0	6X10 EPDM PIPE FOR WASHING SYSTEM	1.410	M	TB3132A0	WHITE-BLUE EPDM TEXTILE BRAID HOSE 6X12	0.770	M	VI1220A1	4,2X12 TCB SELF-TAPPING SCREW	3	PZ	VL1019A0	VIBRATION PUMP	1	PZ	VL1047A1	D6 PIPE HOLDER - D8 J.G. TERMINAL	1	PZ	VL1065A1	1/4 MALE N.O. PRESSURE SWITCH	1	PZ	VL1102A1	DETERGENT LINE FILTER + BARBED VNR 6 MM	1	PZ	VL1128A0	D6 BARBED CHECK VALVE	2	PZ	VL1128A1	D6 BARBED CHECK VALVE	2	PZ	VL1165A0	BB6-AR6 STRAIGHT FITTING	1	PZ	VL1166A0	BB6-AR6 L FITTING	3	PZ	VL1174C0	D1.2 MM CALIBRATED NOZZLE	1	PZ	VL1185A0	2 WAYS PLUS WASHING DISTRIBUTOR	1	PZ	VL1190A0	PLUS WASHING SYSTEM INLET DISTRIBUTOR	1	PZ
Code	Description	Qty	UOM																																																																																		
RC1019A0	D=10 ELASTIC CLAMP	14	PZ																																																																																		
RC1130A0	130X2,6 CLAM	5	PZ																																																																																		
RC1131A0	200X2.6 BLACK CLAMP	2	PZ																																																																																		
RC1242A0	D=10 CLOSED CAP	2	PZ																																																																																		
RC1356A0	"STRAIGHT THREADED FEMALE END 8X1/4" BS	1	PZ																																																																																		
TB2820A0	6X10 EPDM PIPE FOR WASHING SYSTEM	1.410	M																																																																																		
TB3132A0	WHITE-BLUE EPDM TEXTILE BRAID HOSE 6X12	0.770	M																																																																																		
VI1220A1	4,2X12 TCB SELF-TAPPING SCREW	3	PZ																																																																																		
VL1019A0	VIBRATION PUMP	1	PZ																																																																																		
VL1047A1	D6 PIPE HOLDER - D8 J.G. TERMINAL	1	PZ																																																																																		
VL1065A1	1/4 MALE N.O. PRESSURE SWITCH	1	PZ																																																																																		
VL1102A1	DETERGENT LINE FILTER + BARBED VNR 6 MM	1	PZ																																																																																		
VL1128A0	D6 BARBED CHECK VALVE	2	PZ																																																																																		
VL1128A1	D6 BARBED CHECK VALVE	2	PZ																																																																																		
VL1165A0	BB6-AR6 STRAIGHT FITTING	1	PZ																																																																																		
VL1166A0	BB6-AR6 L FITTING	3	PZ																																																																																		
VL1174C0	D1.2 MM CALIBRATED NOZZLE	1	PZ																																																																																		
VL1185A0	2 WAYS PLUS WASHING DISTRIBUTOR	1	PZ																																																																																		
VL1190A0	PLUS WASHING SYSTEM INLET DISTRIBUTOR	1	PZ																																																																																		

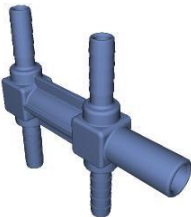
COMPONENT			SPARE PART																																																			
Code	Description	Image	Code	Description	Components list																																																	
VL1190A	PLUS WASHING SYSTEM INLET DISTRIBUTOR		KVL1183A	1 ROTOR ARM PLUS CLEANING SYSTEM KIT	<table border="1"> <thead> <tr> <th>Code</th> <th>Description</th> <th>Qty</th> <th>UOM</th> </tr> </thead> <tbody> <tr> <td>VM1605A0</td> <td>CLIP TWIST LOCK DIAM. 10,2-12,7 MM</td> <td>3</td> <td>PZ</td> </tr> <tr> <td>VM2172A0</td> <td>PUMP-WITH-RCUIT LOCKING PIN</td> <td>7</td> <td>PZ</td> </tr> </tbody> </table>	Code	Description	Qty	UOM	VM1605A0	CLIP TWIST LOCK DIAM. 10,2-12,7 MM	3	PZ	VM2172A0	PUMP-WITH-RCUIT LOCKING PIN	7	PZ																																					
			Code	Description	Qty	UOM																																																
			VM1605A0	CLIP TWIST LOCK DIAM. 10,2-12,7 MM	3	PZ																																																
VM2172A0	PUMP-WITH-RCUIT LOCKING PIN	7	PZ																																																			
KVL0684A	2-3 ROTOR ARM PLUS WASH PUMP+NOZZLE KIT	<table border="1"> <thead> <tr> <th>Code</th> <th>Description</th> <th>Qty</th> <th>UOM</th> </tr> </thead> <tbody> <tr> <td>GN1526A0</td> <td>INT. D.=6.9 TH=1.8 O-RIN</td> <td>4</td> <td>PZ</td> </tr> <tr> <td>RC1019A0</td> <td>D=10 ELASTIC CLAMP</td> <td>4</td> <td>PZ</td> </tr> <tr> <td>RC1130A0</td> <td>130X2,6 CLAM</td> <td>1</td> <td>PZ</td> </tr> <tr> <td>RC1131A0</td> <td>200X2,6 BLACK CLAMP</td> <td>3</td> <td>PZ</td> </tr> <tr> <td>RC1242A0</td> <td>D=10 CLOSED CAP</td> <td>2</td> <td>PZ</td> </tr> <tr> <td>TB2820A0</td> <td>6X10 EPDM PIPE FOR WASHING SYSTEM</td> <td>0.120</td> <td>M</td> </tr> <tr> <td>VL1019A0</td> <td>VIBRATION PUMP</td> <td>1</td> <td>PZ</td> </tr> <tr> <td>VL1128A1</td> <td>D6 BARBED CHECK VALVE</td> <td>1</td> <td>PZ</td> </tr> <tr> <td>VL1174C0</td> <td>D1.2 MM CALIBRATED NOZZLE</td> <td>1</td> <td>PZ</td> </tr> <tr> <td>VL1186A0</td> <td>3 WAYS PLUS WASHING DISTRIBUTOR</td> <td>1</td> <td>PZ</td> </tr> <tr> <td>VL1190A0</td> <td>PLUS WASHING SYSTEM INLET DISTRIBUTOR</td> <td>1</td> <td>PZ</td> </tr> <tr> <td>VM2172A0</td> <td>PUMP-WITH-RCUIT LOCKING PIN</td> <td>1</td> <td>PZ</td> </tr> </tbody> </table>	Code	Description	Qty	UOM	GN1526A0	INT. D.=6.9 TH=1.8 O-RIN	4	PZ	RC1019A0	D=10 ELASTIC CLAMP	4	PZ	RC1130A0	130X2,6 CLAM	1	PZ	RC1131A0	200X2,6 BLACK CLAMP	3	PZ	RC1242A0	D=10 CLOSED CAP	2	PZ	TB2820A0	6X10 EPDM PIPE FOR WASHING SYSTEM	0.120	M	VL1019A0	VIBRATION PUMP	1	PZ	VL1128A1	D6 BARBED CHECK VALVE	1	PZ	VL1174C0	D1.2 MM CALIBRATED NOZZLE	1	PZ	VL1186A0	3 WAYS PLUS WASHING DISTRIBUTOR	1	PZ	VL1190A0	PLUS WASHING SYSTEM INLET DISTRIBUTOR	1	PZ	VM2172A0	PUMP-WITH-RCUIT LOCKING PIN	1	PZ
Code	Description	Qty	UOM																																																			
GN1526A0	INT. D.=6.9 TH=1.8 O-RIN	4	PZ																																																			
RC1019A0	D=10 ELASTIC CLAMP	4	PZ																																																			
RC1130A0	130X2,6 CLAM	1	PZ																																																			
RC1131A0	200X2,6 BLACK CLAMP	3	PZ																																																			
RC1242A0	D=10 CLOSED CAP	2	PZ																																																			
TB2820A0	6X10 EPDM PIPE FOR WASHING SYSTEM	0.120	M																																																			
VL1019A0	VIBRATION PUMP	1	PZ																																																			
VL1128A1	D6 BARBED CHECK VALVE	1	PZ																																																			
VL1174C0	D1.2 MM CALIBRATED NOZZLE	1	PZ																																																			
VL1186A0	3 WAYS PLUS WASHING DISTRIBUTOR	1	PZ																																																			
VL1190A0	PLUS WASHING SYSTEM INLET DISTRIBUTOR	1	PZ																																																			
VM2172A0	PUMP-WITH-RCUIT LOCKING PIN	1	PZ																																																			
KVL0683A	1 ROTOR ARM PLUS WASH PUMP+NOZZLE KIT	<table border="1"> <thead> <tr> <th>Code</th> <th>Description</th> <th>Qty</th> <th>UOM</th> </tr> </thead> <tbody> <tr> <td>GN1526A0</td> <td>INT. D.=6.9 TH=1.8 O-RIN</td> <td>3</td> <td>PZ</td> </tr> <tr> <td>RC1019A0</td> <td>D=10 ELASTIC CLAMP</td> <td>4</td> <td>PZ</td> </tr> <tr> <td>RC1130A0</td> <td>130X2,6 CLAM</td> <td>1</td> <td>PZ</td> </tr> <tr> <td>RC1131A0</td> <td>200X2,6 BLACK CLAMP</td> <td>2</td> <td>PZ</td> </tr> <tr> <td>RC1242A0</td> <td>D=10 CLOSED CAP</td> <td>2</td> <td>PZ</td> </tr> <tr> <td>TB2820A0</td> <td>6X10 EPDM PIPE FOR WASHING SYSTEM</td> <td>0.120</td> <td>M</td> </tr> <tr> <td>VL1019A0</td> <td>VIBRATION PUMP</td> <td>1</td> <td>PZ</td> </tr> </tbody> </table>	Code	Description	Qty	UOM	GN1526A0	INT. D.=6.9 TH=1.8 O-RIN	3	PZ	RC1019A0	D=10 ELASTIC CLAMP	4	PZ	RC1130A0	130X2,6 CLAM	1	PZ	RC1131A0	200X2,6 BLACK CLAMP	2	PZ	RC1242A0	D=10 CLOSED CAP	2	PZ	TB2820A0	6X10 EPDM PIPE FOR WASHING SYSTEM	0.120	M	VL1019A0	VIBRATION PUMP	1	PZ																				
Code	Description	Qty	UOM																																																			
GN1526A0	INT. D.=6.9 TH=1.8 O-RIN	3	PZ																																																			
RC1019A0	D=10 ELASTIC CLAMP	4	PZ																																																			
RC1130A0	130X2,6 CLAM	1	PZ																																																			
RC1131A0	200X2,6 BLACK CLAMP	2	PZ																																																			
RC1242A0	D=10 CLOSED CAP	2	PZ																																																			
TB2820A0	6X10 EPDM PIPE FOR WASHING SYSTEM	0.120	M																																																			
VL1019A0	VIBRATION PUMP	1	PZ																																																			

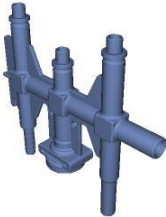
COMPONENT			SPARE PART																																						
Code	Description	Image	Code	Description	Components list																																				
VL1190A	PLUS WASHING SYSTEM INLET DISTRIBUTOR		KVL0683A	1 ROTOR ARM PLUS WASH PUMP+NOZZLE KIT	<table border="1"> <thead> <tr> <th>Code</th> <th>Description</th> <th>Qty</th> <th>UOM</th> </tr> </thead> <tbody> <tr> <td>VL1128A1</td> <td>D6 BARBED CHECK VALVE</td> <td>1</td> <td>PZ</td> </tr> <tr> <td>VL1174C0</td> <td>D1.2 MM CALIBRATED NOZZLE</td> <td>1</td> <td>PZ</td> </tr> <tr> <td>VL1185A0</td> <td>2 WAYS PLUS WASHING DISTRIBUTOR</td> <td>1</td> <td>PZ</td> </tr> <tr> <td>VL1190A0</td> <td>PLUS WASHING SYSTEM INLET DISTRIBUTOR</td> <td>1</td> <td>PZ</td> </tr> <tr> <td>VM2172A0</td> <td>PUMP-WITH-CI RCUIT LOCKING PIN</td> <td>1</td> <td>PZ</td> </tr> </tbody> </table>	Code	Description	Qty	UOM	VL1128A1	D6 BARBED CHECK VALVE	1	PZ	VL1174C0	D1.2 MM CALIBRATED NOZZLE	1	PZ	VL1185A0	2 WAYS PLUS WASHING DISTRIBUTOR	1	PZ	VL1190A0	PLUS WASHING SYSTEM INLET DISTRIBUTOR	1	PZ	VM2172A0	PUMP-WITH-CI RCUIT LOCKING PIN	1	PZ												
Code	Description	Qty	UOM																																						
VL1128A1	D6 BARBED CHECK VALVE	1	PZ																																						
VL1174C0	D1.2 MM CALIBRATED NOZZLE	1	PZ																																						
VL1185A0	2 WAYS PLUS WASHING DISTRIBUTOR	1	PZ																																						
VL1190A0	PLUS WASHING SYSTEM INLET DISTRIBUTOR	1	PZ																																						
VM2172A0	PUMP-WITH-CI RCUIT LOCKING PIN	1	PZ																																						
VL1128A	D6 BARBED CHECK VALVE		KVL1128A	D6 VNR BARBED VALVE KIT	<table border="1"> <thead> <tr> <th>Code</th> <th>Description</th> <th>Qty</th> <th>UOM</th> </tr> </thead> <tbody> <tr> <td>0H2143A0</td> <td>LAMIERA BLOCCA VNR VL1128</td> <td>1</td> <td>PZ</td> </tr> <tr> <td>RC1019A0</td> <td>D=10 ELASTIC CLAMP</td> <td>4</td> <td>PZ</td> </tr> <tr> <td>RC1130A0</td> <td>130X2,6 CLAM</td> <td>1</td> <td>PZ</td> </tr> <tr> <td>TB2820A0</td> <td>6X10 EPDM PIPE FOR WASHING SYSTEM</td> <td>0.080</td> <td>M</td> </tr> <tr> <td>VL1128A0</td> <td>D6 BARBED CHECK VALVE</td> <td>1</td> <td>PZ</td> </tr> <tr> <td>VL1128A1</td> <td>D6 BARBED CHECK VALVE</td> <td>1</td> <td>PZ</td> </tr> <tr> <td>VM1224A0</td> <td>65MY 220MM 2 COLOURS SHRINK TUBE</td> <td>0.200</td> <td>M</td> </tr> </tbody> </table>	Code	Description	Qty	UOM	0H2143A0	LAMIERA BLOCCA VNR VL1128	1	PZ	RC1019A0	D=10 ELASTIC CLAMP	4	PZ	RC1130A0	130X2,6 CLAM	1	PZ	TB2820A0	6X10 EPDM PIPE FOR WASHING SYSTEM	0.080	M	VL1128A0	D6 BARBED CHECK VALVE	1	PZ	VL1128A1	D6 BARBED CHECK VALVE	1	PZ	VM1224A0	65MY 220MM 2 COLOURS SHRINK TUBE	0.200	M				
Code	Description	Qty	UOM																																						
0H2143A0	LAMIERA BLOCCA VNR VL1128	1	PZ																																						
RC1019A0	D=10 ELASTIC CLAMP	4	PZ																																						
RC1130A0	130X2,6 CLAM	1	PZ																																						
TB2820A0	6X10 EPDM PIPE FOR WASHING SYSTEM	0.080	M																																						
VL1128A0	D6 BARBED CHECK VALVE	1	PZ																																						
VL1128A1	D6 BARBED CHECK VALVE	1	PZ																																						
VM1224A0	65MY 220MM 2 COLOURS SHRINK TUBE	0.200	M																																						
VL1186A	3 WAYS PLUS WASHING DISTRIBUTOR		KVL1209A	US PLUS 3 ROTOR ARMS WASHING SYSTEM KIT	<table border="1"> <thead> <tr> <th>Code</th> <th>Description</th> <th>Qty</th> <th>UOM</th> </tr> </thead> <tbody> <tr> <td>0H2354A0</td> <td>XEVC-XEVL WASHING CIRCUIT PLAT</td> <td>1</td> <td>PZ</td> </tr> <tr> <td>0H2411A0</td> <td></td> <td>1</td> <td>PZ</td> </tr> <tr> <td>EL1450A0</td> <td>US SELF-CLEANING WATER SOLENOID</td> <td>4</td> <td>PZ</td> </tr> <tr> <td>GN1526A0</td> <td>INT. D.=6.9 TH=1.8 O-RING</td> <td>9</td> <td>PZ</td> </tr> <tr> <td>RC1018A0</td> <td>ZINC PLATED D12 ELASTIC CLAMP</td> <td>13</td> <td>PZ</td> </tr> <tr> <td>RC1019A0</td> <td>D=10 ELASTIC CLAMP</td> <td>15</td> <td>PZ</td> </tr> <tr> <td>RC1130A0</td> <td>130X2,6 CLAM</td> <td>1</td> <td>PZ</td> </tr> <tr> <td>RC1131A0</td> <td>200X2.6 BLACK CLAMP</td> <td>3</td> <td>PZ</td> </tr> </tbody> </table>	Code	Description	Qty	UOM	0H2354A0	XEVC-XEVL WASHING CIRCUIT PLAT	1	PZ	0H2411A0		1	PZ	EL1450A0	US SELF-CLEANING WATER SOLENOID	4	PZ	GN1526A0	INT. D.=6.9 TH=1.8 O-RING	9	PZ	RC1018A0	ZINC PLATED D12 ELASTIC CLAMP	13	PZ	RC1019A0	D=10 ELASTIC CLAMP	15	PZ	RC1130A0	130X2,6 CLAM	1	PZ	RC1131A0	200X2.6 BLACK CLAMP	3	PZ
Code	Description	Qty	UOM																																						
0H2354A0	XEVC-XEVL WASHING CIRCUIT PLAT	1	PZ																																						
0H2411A0		1	PZ																																						
EL1450A0	US SELF-CLEANING WATER SOLENOID	4	PZ																																						
GN1526A0	INT. D.=6.9 TH=1.8 O-RING	9	PZ																																						
RC1018A0	ZINC PLATED D12 ELASTIC CLAMP	13	PZ																																						
RC1019A0	D=10 ELASTIC CLAMP	15	PZ																																						
RC1130A0	130X2,6 CLAM	1	PZ																																						
RC1131A0	200X2.6 BLACK CLAMP	3	PZ																																						

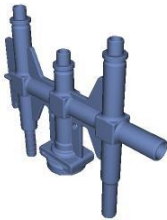

COMPONENT			SPARE PART																																																																														
Code	Description	Image	Code	Description	Components list																																																																												
VL1186A	3 WAYS PLUS WASHING DISTRIBUTOR		KVL1209A	US PLUS 3 ROTOR ARMS WASHING SYSTEM KIT	<table border="1"> <thead> <tr> <th>Code</th> <th>Description</th> <th>Qty</th> <th>UOM</th> </tr> </thead> <tbody> <tr> <td>RC1242A0</td> <td>D=10 CLOSED CAP</td> <td>2</td> <td>PZ</td> </tr> <tr> <td>RC1356A0</td> <td>"STRAIGHT THREADED FEMALE END 8X1/4" BS</td> <td>1</td> <td>PZ</td> </tr> <tr> <td>TB2820A0</td> <td>6X10 EPDM PIPE FOR WASHING SYSTEM</td> <td>2.750</td> <td>M</td> </tr> <tr> <td>TB3132A0</td> <td>WHITE-BLUE EPDM TEXTILE BRAID HOSE 6X12</td> <td>1.980</td> <td>M</td> </tr> <tr> <td>VI1220A1</td> <td>4,2X12 TCB SELF-TAPPING SCREW</td> <td>3</td> <td>PZ</td> </tr> <tr> <td>VL1019A0</td> <td>VIBRATION PUMP</td> <td>1</td> <td>PZ</td> </tr> <tr> <td>VL1065A1</td> <td>1/4 MALE N.O. PRESSURE SWITCH</td> <td>1</td> <td>PZ</td> </tr> <tr> <td>VL1102A1</td> <td>DETERGENT LINE FILTER + BARBED VNR 6 MM</td> <td>1</td> <td>PZ</td> </tr> <tr> <td>VL1127A1</td> <td>6MM BARBED T-SHAPED FITTING</td> <td>2</td> <td>PZ</td> </tr> <tr> <td>VL1128A1</td> <td>D6 BARBED CHECK VALVE</td> <td>3</td> <td>PZ</td> </tr> <tr> <td>VL1165A0</td> <td>BB6-AR6 STRAIGHT FITTING</td> <td>1</td> <td>PZ</td> </tr> <tr> <td>VL1166A0</td> <td>BB6-AR6 L FITTING</td> <td>4</td> <td>PZ</td> </tr> <tr> <td>VL1167A0</td> <td></td> <td>1</td> <td>PZ</td> </tr> <tr> <td>VL1167A1</td> <td></td> <td>1</td> <td>PZ</td> </tr> <tr> <td>VL1167A2</td> <td>GN21 3 ROTOR ARMS B-B FLOW RESTRICTOR</td> <td>1</td> <td>PZ</td> </tr> <tr> <td>VL1174C0</td> <td>D1.2 MM CALIBRATED NOZZLE</td> <td>1</td> <td>PZ</td> </tr> <tr> <td>VL1185A0</td> <td>2 WAYS PLUS WASHING DISTRIBUTOR</td> <td>1</td> <td>PZ</td> </tr> <tr> <td>VL1186A0</td> <td>3 WAYS PLUS WASHING DISTRIBUTOR</td> <td>1</td> <td>PZ</td> </tr> </tbody> </table>	Code	Description	Qty	UOM	RC1242A0	D=10 CLOSED CAP	2	PZ	RC1356A0	"STRAIGHT THREADED FEMALE END 8X1/4" BS	1	PZ	TB2820A0	6X10 EPDM PIPE FOR WASHING SYSTEM	2.750	M	TB3132A0	WHITE-BLUE EPDM TEXTILE BRAID HOSE 6X12	1.980	M	VI1220A1	4,2X12 TCB SELF-TAPPING SCREW	3	PZ	VL1019A0	VIBRATION PUMP	1	PZ	VL1065A1	1/4 MALE N.O. PRESSURE SWITCH	1	PZ	VL1102A1	DETERGENT LINE FILTER + BARBED VNR 6 MM	1	PZ	VL1127A1	6MM BARBED T-SHAPED FITTING	2	PZ	VL1128A1	D6 BARBED CHECK VALVE	3	PZ	VL1165A0	BB6-AR6 STRAIGHT FITTING	1	PZ	VL1166A0	BB6-AR6 L FITTING	4	PZ	VL1167A0		1	PZ	VL1167A1		1	PZ	VL1167A2	GN21 3 ROTOR ARMS B-B FLOW RESTRICTOR	1	PZ	VL1174C0	D1.2 MM CALIBRATED NOZZLE	1	PZ	VL1185A0	2 WAYS PLUS WASHING DISTRIBUTOR	1	PZ	VL1186A0	3 WAYS PLUS WASHING DISTRIBUTOR	1	PZ
					Code	Description	Qty	UOM																																																																									
					RC1242A0	D=10 CLOSED CAP	2	PZ																																																																									
					RC1356A0	"STRAIGHT THREADED FEMALE END 8X1/4" BS	1	PZ																																																																									
					TB2820A0	6X10 EPDM PIPE FOR WASHING SYSTEM	2.750	M																																																																									
					TB3132A0	WHITE-BLUE EPDM TEXTILE BRAID HOSE 6X12	1.980	M																																																																									
					VI1220A1	4,2X12 TCB SELF-TAPPING SCREW	3	PZ																																																																									
					VL1019A0	VIBRATION PUMP	1	PZ																																																																									
					VL1065A1	1/4 MALE N.O. PRESSURE SWITCH	1	PZ																																																																									
					VL1102A1	DETERGENT LINE FILTER + BARBED VNR 6 MM	1	PZ																																																																									
					VL1127A1	6MM BARBED T-SHAPED FITTING	2	PZ																																																																									
					VL1128A1	D6 BARBED CHECK VALVE	3	PZ																																																																									
					VL1165A0	BB6-AR6 STRAIGHT FITTING	1	PZ																																																																									
					VL1166A0	BB6-AR6 L FITTING	4	PZ																																																																									
					VL1167A0		1	PZ																																																																									
					VL1167A1		1	PZ																																																																									
					VL1167A2	GN21 3 ROTOR ARMS B-B FLOW RESTRICTOR	1	PZ																																																																									
					VL1174C0	D1.2 MM CALIBRATED NOZZLE	1	PZ																																																																									
					VL1185A0	2 WAYS PLUS WASHING DISTRIBUTOR	1	PZ																																																																									
					VL1186A0	3 WAYS PLUS WASHING DISTRIBUTOR	1	PZ																																																																									

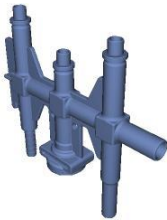

COMPONENT			SPARE PART																																																																			
Code	Description	Image	Code	Description	Components list																																																																	
VL1186A	3 WAYS PLUS WASHING DISTRIBUTOR		KVL1209A	US PLUS 3 ROTOR ARMS WASHING SYSTEM KIT	<table border="1"> <thead> <tr> <th>Code</th> <th>Description</th> <th>Qty</th> <th>UOM</th> </tr> </thead> <tbody> <tr> <td>VL1190A0</td> <td>PLUS WASHING SYSTEM INLET DISTRIBUTOR</td> <td>1</td> <td>PZ</td> </tr> <tr> <td>VM1605A0</td> <td>CLIP TWIST LOCK DIAM. 10,2-12,7 MM</td> <td>6</td> <td>PZ</td> </tr> <tr> <td>VM2172A0</td> <td>PUMP-WITH-CI RCUIT LOCKING PIN</td> <td>9</td> <td>PZ</td> </tr> </tbody> </table>	Code	Description	Qty	UOM	VL1190A0	PLUS WASHING SYSTEM INLET DISTRIBUTOR	1	PZ	VM1605A0	CLIP TWIST LOCK DIAM. 10,2-12,7 MM	6	PZ	VM2172A0	PUMP-WITH-CI RCUIT LOCKING PIN	9	PZ																																																	
			Code	Description	Qty	UOM																																																																
VL1190A0	PLUS WASHING SYSTEM INLET DISTRIBUTOR	1	PZ																																																																			
VM1605A0	CLIP TWIST LOCK DIAM. 10,2-12,7 MM	6	PZ																																																																			
VM2172A0	PUMP-WITH-CI RCUIT LOCKING PIN	9	PZ																																																																			
KVL1208A	US PLUS 2 ROTOR ARMS WASHING SYSTEM KIT	<table border="1"> <thead> <tr> <th>Code</th> <th>Description</th> <th>Qty</th> <th>UOM</th> </tr> </thead> <tbody> <tr> <td>0H2354A0</td> <td>XEVC-XEVL WASHING CIRCUIT PLAT</td> <td>1</td> <td>PZ</td> </tr> <tr> <td>0H2411A0</td> <td></td> <td>1</td> <td>PZ</td> </tr> <tr> <td>EL1450A0</td> <td>US SELF-CLEANIN G WATER SOLENOID</td> <td>4</td> <td>PZ</td> </tr> <tr> <td>GN1526A0</td> <td>INT. D.=6.9 TH=1.8 O-RIN</td> <td>9</td> <td>PZ</td> </tr> <tr> <td>RC1018A0</td> <td>ZINC PLATED D12 ELASTIC CLAMP</td> <td>4</td> <td>PZ</td> </tr> <tr> <td>RC1019A0</td> <td>D=10 ELASTIC CLAMP</td> <td>16</td> <td>PZ</td> </tr> <tr> <td>RC1130A0</td> <td>130X2,6 CLAM</td> <td>1</td> <td>PZ</td> </tr> <tr> <td>RC1131A0</td> <td>200X2,6 BLACK CLAMP</td> <td>3</td> <td>PZ</td> </tr> <tr> <td>RC1242A0</td> <td>D=10 CLOSED CAP</td> <td>2</td> <td>PZ</td> </tr> <tr> <td>RC1356A0</td> <td>*STRAIGHT THREADED FEMALE END 8X1/4" BS</td> <td>1</td> <td>PZ</td> </tr> <tr> <td>TB2820A0</td> <td>6X10 EPDM PIPE FOR WASHING SYSTEM</td> <td>2.890</td> <td>M</td> </tr> <tr> <td>TB3132A0</td> <td>WHITE-BLUE EPDM TEXTILE BRAID HOSE 6X12</td> <td>1.600</td> <td>M</td> </tr> <tr> <td>VI1220A1</td> <td>4,2X12 TCB SELF-TAPPIN G SCREW</td> <td>3</td> <td>PZ</td> </tr> <tr> <td>VL1019A0</td> <td>VIBRATION PUMP</td> <td>1</td> <td>PZ</td> </tr> <tr> <td>VL1047A1</td> <td>D6 PIPE HOLDER - D8 J.G. TERMINAL</td> <td>1</td> <td>PZ</td> </tr> <tr> <td>VL1065A1</td> <td>1/4 MALE N.O. PRESSURE SWITCH</td> <td>1</td> <td>PZ</td> </tr> </tbody> </table>	Code	Description	Qty	UOM	0H2354A0	XEVC-XEVL WASHING CIRCUIT PLAT	1	PZ	0H2411A0		1	PZ	EL1450A0	US SELF-CLEANIN G WATER SOLENOID	4	PZ	GN1526A0	INT. D.=6.9 TH=1.8 O-RIN	9	PZ	RC1018A0	ZINC PLATED D12 ELASTIC CLAMP	4	PZ	RC1019A0	D=10 ELASTIC CLAMP	16	PZ	RC1130A0	130X2,6 CLAM	1	PZ	RC1131A0	200X2,6 BLACK CLAMP	3	PZ	RC1242A0	D=10 CLOSED CAP	2	PZ	RC1356A0	*STRAIGHT THREADED FEMALE END 8X1/4" BS	1	PZ	TB2820A0	6X10 EPDM PIPE FOR WASHING SYSTEM	2.890	M	TB3132A0	WHITE-BLUE EPDM TEXTILE BRAID HOSE 6X12	1.600	M	VI1220A1	4,2X12 TCB SELF-TAPPIN G SCREW	3	PZ	VL1019A0	VIBRATION PUMP	1	PZ	VL1047A1	D6 PIPE HOLDER - D8 J.G. TERMINAL	1	PZ	VL1065A1	1/4 MALE N.O. PRESSURE SWITCH	1	PZ
Code	Description	Qty	UOM																																																																			
0H2354A0	XEVC-XEVL WASHING CIRCUIT PLAT	1	PZ																																																																			
0H2411A0		1	PZ																																																																			
EL1450A0	US SELF-CLEANIN G WATER SOLENOID	4	PZ																																																																			
GN1526A0	INT. D.=6.9 TH=1.8 O-RIN	9	PZ																																																																			
RC1018A0	ZINC PLATED D12 ELASTIC CLAMP	4	PZ																																																																			
RC1019A0	D=10 ELASTIC CLAMP	16	PZ																																																																			
RC1130A0	130X2,6 CLAM	1	PZ																																																																			
RC1131A0	200X2,6 BLACK CLAMP	3	PZ																																																																			
RC1242A0	D=10 CLOSED CAP	2	PZ																																																																			
RC1356A0	*STRAIGHT THREADED FEMALE END 8X1/4" BS	1	PZ																																																																			
TB2820A0	6X10 EPDM PIPE FOR WASHING SYSTEM	2.890	M																																																																			
TB3132A0	WHITE-BLUE EPDM TEXTILE BRAID HOSE 6X12	1.600	M																																																																			
VI1220A1	4,2X12 TCB SELF-TAPPIN G SCREW	3	PZ																																																																			
VL1019A0	VIBRATION PUMP	1	PZ																																																																			
VL1047A1	D6 PIPE HOLDER - D8 J.G. TERMINAL	1	PZ																																																																			
VL1065A1	1/4 MALE N.O. PRESSURE SWITCH	1	PZ																																																																			

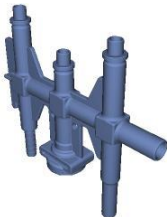

COMPONENT			SPARE PART																																														
Code	Description	Image	Code	Description	Components list																																												
VL1186A	3 WAYS PLUS WASHING DISTRIBUTOR		KVL1208A	US PLUS 2 ROTOR ARMS WASHING SYSTEM KIT	<table border="1"> <thead> <tr> <th>Code</th> <th>Description</th> <th>Qty</th> <th>UOM</th> </tr> </thead> <tbody> <tr> <td>VL1102A1</td> <td>DETERGENT LINE FILTER + BARBED VNR 6 MM</td> <td>1</td> <td>PZ</td> </tr> <tr> <td>VL1128A1</td> <td>D6 BARBED CHECK VALVE</td> <td>2</td> <td>PZ</td> </tr> <tr> <td>VL1141A1</td> <td>STRAIGHT CONNECT BB6-BB6</td> <td>1</td> <td>PZ</td> </tr> <tr> <td>VL1165A0</td> <td>BB6-AR6 STRAIGHT FITTING</td> <td>1</td> <td>PZ</td> </tr> <tr> <td>VL1166A0</td> <td>BB6-AR6 L FITTING</td> <td>4</td> <td>PZ</td> </tr> <tr> <td>VL1174C0</td> <td>D1.2 MM CALIBRATED NOZZLE</td> <td>1</td> <td>PZ</td> </tr> <tr> <td>VL1186A0</td> <td>3 WAYS PLUS WASHING DISTRIBUTOR</td> <td>1</td> <td>PZ</td> </tr> <tr> <td>VL1190A0</td> <td>PLUS WASHING SYSTEM INLET DISTRIBUTOR</td> <td>1</td> <td>PZ</td> </tr> <tr> <td>VM1605A0</td> <td>CLIP TWIST LOCK DIAM. 10.2-12.7 MM</td> <td>6</td> <td>PZ</td> </tr> <tr> <td>VM2172A0</td> <td>PUMP-WITH-CI RCUIT LOCKING PIN</td> <td>9</td> <td>PZ</td> </tr> </tbody> </table>	Code	Description	Qty	UOM	VL1102A1	DETERGENT LINE FILTER + BARBED VNR 6 MM	1	PZ	VL1128A1	D6 BARBED CHECK VALVE	2	PZ	VL1141A1	STRAIGHT CONNECT BB6-BB6	1	PZ	VL1165A0	BB6-AR6 STRAIGHT FITTING	1	PZ	VL1166A0	BB6-AR6 L FITTING	4	PZ	VL1174C0	D1.2 MM CALIBRATED NOZZLE	1	PZ	VL1186A0	3 WAYS PLUS WASHING DISTRIBUTOR	1	PZ	VL1190A0	PLUS WASHING SYSTEM INLET DISTRIBUTOR	1	PZ	VM1605A0	CLIP TWIST LOCK DIAM. 10.2-12.7 MM	6	PZ	VM2172A0	PUMP-WITH-CI RCUIT LOCKING PIN	9	PZ
			Code	Description	Qty	UOM																																											
VL1102A1	DETERGENT LINE FILTER + BARBED VNR 6 MM	1	PZ																																														
VL1128A1	D6 BARBED CHECK VALVE	2	PZ																																														
VL1141A1	STRAIGHT CONNECT BB6-BB6	1	PZ																																														
VL1165A0	BB6-AR6 STRAIGHT FITTING	1	PZ																																														
VL1166A0	BB6-AR6 L FITTING	4	PZ																																														
VL1174C0	D1.2 MM CALIBRATED NOZZLE	1	PZ																																														
VL1186A0	3 WAYS PLUS WASHING DISTRIBUTOR	1	PZ																																														
VL1190A0	PLUS WASHING SYSTEM INLET DISTRIBUTOR	1	PZ																																														
VM1605A0	CLIP TWIST LOCK DIAM. 10.2-12.7 MM	6	PZ																																														
VM2172A0	PUMP-WITH-CI RCUIT LOCKING PIN	9	PZ																																														
KVL1187A	3 ROTOR ARMS PLUS EU CLEANING SYSTEM KIT	<table border="1"> <thead> <tr> <th>Code</th> <th>Description</th> <th>Qty</th> <th>UOM</th> </tr> </thead> <tbody> <tr> <td>0H2143A0</td> <td>LAMIERA BLOCCA VNR VL1128</td> <td>3</td> <td>PZ</td> </tr> <tr> <td>0H2168A0</td> <td></td> <td>1</td> <td>PZ</td> </tr> <tr> <td>0H2354A0</td> <td>XEVC-XEVL WASHING CIRCUIT PLAT</td> <td>1</td> <td>PZ</td> </tr> <tr> <td>EL1120A0</td> <td>D8-D6 FEMALE STRAIGHT INTERM. CONNECTION</td> <td>1</td> <td>PZ</td> </tr> <tr> <td>EL1220A0</td> <td>JG STRAIGHT CONNECTION Ø8F-Ø8F</td> <td>2</td> <td>PZ</td> </tr> <tr> <td>EL1440A0</td> <td>WATER SELF CLEANING VALVE</td> <td>4</td> <td>PZ</td> </tr> <tr> <td>GN1526A0</td> <td>INT. D.=6.9 TH=1.8 O-RIN</td> <td>9</td> <td>PZ</td> </tr> <tr> <td>RC1018A0</td> <td>ZINC PLATED D12 ELASTIC CLAMP</td> <td>10</td> <td>PZ</td> </tr> </tbody> </table>	Code	Description	Qty	UOM	0H2143A0	LAMIERA BLOCCA VNR VL1128	3	PZ	0H2168A0		1	PZ	0H2354A0	XEVC-XEVL WASHING CIRCUIT PLAT	1	PZ	EL1120A0	D8-D6 FEMALE STRAIGHT INTERM. CONNECTION	1	PZ	EL1220A0	JG STRAIGHT CONNECTION Ø8F-Ø8F	2	PZ	EL1440A0	WATER SELF CLEANING VALVE	4	PZ	GN1526A0	INT. D.=6.9 TH=1.8 O-RIN	9	PZ	RC1018A0	ZINC PLATED D12 ELASTIC CLAMP	10	PZ											
Code	Description	Qty	UOM																																														
0H2143A0	LAMIERA BLOCCA VNR VL1128	3	PZ																																														
0H2168A0		1	PZ																																														
0H2354A0	XEVC-XEVL WASHING CIRCUIT PLAT	1	PZ																																														
EL1120A0	D8-D6 FEMALE STRAIGHT INTERM. CONNECTION	1	PZ																																														
EL1220A0	JG STRAIGHT CONNECTION Ø8F-Ø8F	2	PZ																																														
EL1440A0	WATER SELF CLEANING VALVE	4	PZ																																														
GN1526A0	INT. D.=6.9 TH=1.8 O-RIN	9	PZ																																														
RC1018A0	ZINC PLATED D12 ELASTIC CLAMP	10	PZ																																														



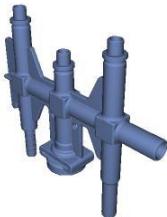

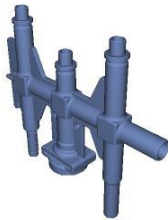

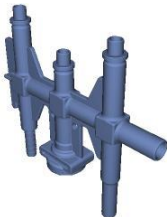
COMPONENT			SPARE PART																																																																														
Code	Description	Image	Code	Description	Components list																																																																												
VL1186A	3 WAYS PLUS WASHING DISTRIBUTOR		KVL1187A	3 ROTOR ARMS PLUS EU CLEANING SYSTEM KIT	<table border="1"> <thead> <tr> <th>Code</th> <th>Description</th> <th>Qty</th> <th>UOM</th> </tr> </thead> <tbody> <tr> <td>RC1019A0</td> <td>D=10 ELASTIC CLAMP</td> <td>22</td> <td>PZ</td> </tr> <tr> <td>RC1130A0</td> <td>130X2,6 CLAM</td> <td>4</td> <td>PZ</td> </tr> <tr> <td>RC1131A0</td> <td>200X2.6 BLACK CLAMP</td> <td>3</td> <td>PZ</td> </tr> <tr> <td>RC1242A0</td> <td>D=10 CLOSED CAP</td> <td>2</td> <td>PZ</td> </tr> <tr> <td>RC1310A0</td> <td>140X4 CLAMP WITH CLIP</td> <td>1</td> <td>PZ</td> </tr> <tr> <td>RC1356A0</td> <td>"STRAIGHT THREADED FEMALE END 8X1/4" BS</td> <td>1</td> <td>PZ</td> </tr> <tr> <td>TB2820A0</td> <td>6X10 EPDM PIPE FOR WASHING SYSTEM</td> <td>1.510</td> <td>M</td> </tr> <tr> <td>TB3132A0</td> <td>WHITE-BLUE EPDM TEXTILE BRAID HOSE 6X12</td> <td>1.210</td> <td>M</td> </tr> <tr> <td>VI1220A1</td> <td>4,2X12 TCB SELF-TAPPING SCREW</td> <td>3</td> <td>PZ</td> </tr> <tr> <td>VL1019A0</td> <td>VIBRATION PUMP</td> <td>1</td> <td>PZ</td> </tr> <tr> <td>VL1046A1</td> <td>D6 PIPE HOLDER - D6 J.G. TERMINAL</td> <td>3</td> <td>PZ</td> </tr> <tr> <td>VL1047A1</td> <td>D6 PIPE HOLDER - D8 J.G. TERMINAL</td> <td>1</td> <td>PZ</td> </tr> <tr> <td>VL1064A0</td> <td>WASHING SYSTEM OUTLETS DISTRIBUTOR</td> <td>1</td> <td>PZ</td> </tr> <tr> <td>VL1065A1</td> <td>1/4 MALE N.O. PRESSURE SWITCH</td> <td>1</td> <td>PZ</td> </tr> <tr> <td>VL1067A0</td> <td>WASHING SYSTEM INLETS DISTRIBUTOR</td> <td>1</td> <td>PZ</td> </tr> <tr> <td>VL1092A0</td> <td>WASHING SYSTEM OUTLET DOUBLE DISTRIBUTOR</td> <td>1</td> <td>PZ</td> </tr> <tr> <td>VL1102A1</td> <td>DETERGENT LINE FILTER + BARBED VNR 6 MM</td> <td>1</td> <td>PZ</td> </tr> <tr> <td>VL1127A1</td> <td>6MM BARBED T-SHAPED FITTING</td> <td>2</td> <td>PZ</td> </tr> </tbody> </table>	Code	Description	Qty	UOM	RC1019A0	D=10 ELASTIC CLAMP	22	PZ	RC1130A0	130X2,6 CLAM	4	PZ	RC1131A0	200X2.6 BLACK CLAMP	3	PZ	RC1242A0	D=10 CLOSED CAP	2	PZ	RC1310A0	140X4 CLAMP WITH CLIP	1	PZ	RC1356A0	"STRAIGHT THREADED FEMALE END 8X1/4" BS	1	PZ	TB2820A0	6X10 EPDM PIPE FOR WASHING SYSTEM	1.510	M	TB3132A0	WHITE-BLUE EPDM TEXTILE BRAID HOSE 6X12	1.210	M	VI1220A1	4,2X12 TCB SELF-TAPPING SCREW	3	PZ	VL1019A0	VIBRATION PUMP	1	PZ	VL1046A1	D6 PIPE HOLDER - D6 J.G. TERMINAL	3	PZ	VL1047A1	D6 PIPE HOLDER - D8 J.G. TERMINAL	1	PZ	VL1064A0	WASHING SYSTEM OUTLETS DISTRIBUTOR	1	PZ	VL1065A1	1/4 MALE N.O. PRESSURE SWITCH	1	PZ	VL1067A0	WASHING SYSTEM INLETS DISTRIBUTOR	1	PZ	VL1092A0	WASHING SYSTEM OUTLET DOUBLE DISTRIBUTOR	1	PZ	VL1102A1	DETERGENT LINE FILTER + BARBED VNR 6 MM	1	PZ	VL1127A1	6MM BARBED T-SHAPED FITTING	2	PZ
Code	Description	Qty	UOM																																																																														
RC1019A0	D=10 ELASTIC CLAMP	22	PZ																																																																														
RC1130A0	130X2,6 CLAM	4	PZ																																																																														
RC1131A0	200X2.6 BLACK CLAMP	3	PZ																																																																														
RC1242A0	D=10 CLOSED CAP	2	PZ																																																																														
RC1310A0	140X4 CLAMP WITH CLIP	1	PZ																																																																														
RC1356A0	"STRAIGHT THREADED FEMALE END 8X1/4" BS	1	PZ																																																																														
TB2820A0	6X10 EPDM PIPE FOR WASHING SYSTEM	1.510	M																																																																														
TB3132A0	WHITE-BLUE EPDM TEXTILE BRAID HOSE 6X12	1.210	M																																																																														
VI1220A1	4,2X12 TCB SELF-TAPPING SCREW	3	PZ																																																																														
VL1019A0	VIBRATION PUMP	1	PZ																																																																														
VL1046A1	D6 PIPE HOLDER - D6 J.G. TERMINAL	3	PZ																																																																														
VL1047A1	D6 PIPE HOLDER - D8 J.G. TERMINAL	1	PZ																																																																														
VL1064A0	WASHING SYSTEM OUTLETS DISTRIBUTOR	1	PZ																																																																														
VL1065A1	1/4 MALE N.O. PRESSURE SWITCH	1	PZ																																																																														
VL1067A0	WASHING SYSTEM INLETS DISTRIBUTOR	1	PZ																																																																														
VL1092A0	WASHING SYSTEM OUTLET DOUBLE DISTRIBUTOR	1	PZ																																																																														
VL1102A1	DETERGENT LINE FILTER + BARBED VNR 6 MM	1	PZ																																																																														
VL1127A1	6MM BARBED T-SHAPED FITTING	2	PZ																																																																														

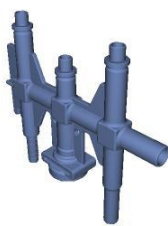
COMPONENT			SPARE PART																																																																																													
Code	Description	Image	Code	Description	Components list																																																																																											
VL1186A	3 WAYS PLUS WASHING DISTRIBUTOR		KVL1187A	3 ROTOR ARMS PLUS EU CLEANING SYSTEM KIT	<table border="1"> <thead> <tr> <th>Code</th> <th>Description</th> <th>Qty</th> <th>UOM</th> </tr> </thead> <tbody> <tr> <td>VL1128A0</td> <td>D6 BARBED CHECK VALVE</td> <td>3</td> <td>PZ</td> </tr> <tr> <td>VL1128A1</td> <td>D6 BARBED CHECK VALVE</td> <td>3</td> <td>PZ</td> </tr> <tr> <td>VL1165A0</td> <td>BB6-AR6 STRAIGHT FITTING</td> <td>4</td> <td>PZ</td> </tr> <tr> <td>VL1166A0</td> <td>BB6-AR6 L FITTING</td> <td>4</td> <td>PZ</td> </tr> <tr> <td>VL1167A0</td> <td></td> <td>1</td> <td>PZ</td> </tr> <tr> <td>VL1167A1</td> <td></td> <td>1</td> <td>PZ</td> </tr> <tr> <td>VL1167A2</td> <td>GN21 3 ROTOR ARMS B-B FLOW RESTRICTOR</td> <td>1</td> <td>PZ</td> </tr> <tr> <td>VL1174C0</td> <td>D1.2 MM CALIBRATED NOZZLE</td> <td>1</td> <td>PZ</td> </tr> <tr> <td>VL1185A0</td> <td>2 WAYS PLUS WASHING DISTRIBUTOR</td> <td>1</td> <td>PZ</td> </tr> <tr> <td>VL1186A0</td> <td>3 WAYS PLUS WASHING DISTRIBUTOR</td> <td>1</td> <td>PZ</td> </tr> <tr> <td>VL1190A0</td> <td>PLUS WASHING SYSTEM INLET DISTRIBUTOR</td> <td>1</td> <td>PZ</td> </tr> <tr> <td>VM1605A0</td> <td>CLIP TWIST LOCK DIAM. 10,2-12,7 MM</td> <td>3</td> <td>PZ</td> </tr> <tr> <td>VM2172A0</td> <td>PUMP-WITH-CI RCUIT LOCKING PIN</td> <td>9</td> <td>PZ</td> </tr> </tbody> </table>	Code	Description	Qty	UOM	VL1128A0	D6 BARBED CHECK VALVE	3	PZ	VL1128A1	D6 BARBED CHECK VALVE	3	PZ	VL1165A0	BB6-AR6 STRAIGHT FITTING	4	PZ	VL1166A0	BB6-AR6 L FITTING	4	PZ	VL1167A0		1	PZ	VL1167A1		1	PZ	VL1167A2	GN21 3 ROTOR ARMS B-B FLOW RESTRICTOR	1	PZ	VL1174C0	D1.2 MM CALIBRATED NOZZLE	1	PZ	VL1185A0	2 WAYS PLUS WASHING DISTRIBUTOR	1	PZ	VL1186A0	3 WAYS PLUS WASHING DISTRIBUTOR	1	PZ	VL1190A0	PLUS WASHING SYSTEM INLET DISTRIBUTOR	1	PZ	VM1605A0	CLIP TWIST LOCK DIAM. 10,2-12,7 MM	3	PZ	VM2172A0	PUMP-WITH-CI RCUIT LOCKING PIN	9	PZ	KVL1184A	2 ROTOR ARMS PLUS EU CLEANING SYSTEM KIT	<table border="1"> <thead> <tr> <th>Code</th> <th>Description</th> <th>Qty</th> <th>UOM</th> </tr> </thead> <tbody> <tr> <td>0H2143A0</td> <td>LAMIERA BLOCCA VNR VL1128</td> <td>2</td> <td>PZ</td> </tr> <tr> <td>0H2168A0</td> <td></td> <td>1</td> <td>PZ</td> </tr> <tr> <td>0H2354A0</td> <td>XEVC-XEVL WASHING CIRCUIT PLAT</td> <td>1</td> <td>PZ</td> </tr> <tr> <td>EL1220A0</td> <td>JG STRAIGHT CONNECTION Ø8F-Ø8F</td> <td>3</td> <td>PZ</td> </tr> <tr> <td>EL1440A0</td> <td>WATER SELF CLEANING VALVE</td> <td>4</td> <td>PZ</td> </tr> <tr> <td>GN1526A0</td> <td>INT. D.=6.9 TH=1.8 O-RIN</td> <td>9</td> <td>PZ</td> </tr> <tr> <td>RC1018A0</td> <td>ZINC PLATED D12 ELASTIC CLAMP</td> <td>2</td> <td>PZ</td> </tr> </tbody> </table>	Code	Description	Qty	UOM	0H2143A0	LAMIERA BLOCCA VNR VL1128	2	PZ	0H2168A0		1	PZ	0H2354A0	XEVC-XEVL WASHING CIRCUIT PLAT	1	PZ	EL1220A0	JG STRAIGHT CONNECTION Ø8F-Ø8F	3	PZ	EL1440A0	WATER SELF CLEANING VALVE	4	PZ	GN1526A0	INT. D.=6.9 TH=1.8 O-RIN	9	PZ	RC1018A0	ZINC PLATED D12 ELASTIC CLAMP	2	PZ
			Code	Description	Qty	UOM																																																																																										
VL1128A0	D6 BARBED CHECK VALVE	3	PZ																																																																																													
VL1128A1	D6 BARBED CHECK VALVE	3	PZ																																																																																													
VL1165A0	BB6-AR6 STRAIGHT FITTING	4	PZ																																																																																													
VL1166A0	BB6-AR6 L FITTING	4	PZ																																																																																													
VL1167A0		1	PZ																																																																																													
VL1167A1		1	PZ																																																																																													
VL1167A2	GN21 3 ROTOR ARMS B-B FLOW RESTRICTOR	1	PZ																																																																																													
VL1174C0	D1.2 MM CALIBRATED NOZZLE	1	PZ																																																																																													
VL1185A0	2 WAYS PLUS WASHING DISTRIBUTOR	1	PZ																																																																																													
VL1186A0	3 WAYS PLUS WASHING DISTRIBUTOR	1	PZ																																																																																													
VL1190A0	PLUS WASHING SYSTEM INLET DISTRIBUTOR	1	PZ																																																																																													
VM1605A0	CLIP TWIST LOCK DIAM. 10,2-12,7 MM	3	PZ																																																																																													
VM2172A0	PUMP-WITH-CI RCUIT LOCKING PIN	9	PZ																																																																																													
Code	Description	Qty	UOM																																																																																													
0H2143A0	LAMIERA BLOCCA VNR VL1128	2	PZ																																																																																													
0H2168A0		1	PZ																																																																																													
0H2354A0	XEVC-XEVL WASHING CIRCUIT PLAT	1	PZ																																																																																													
EL1220A0	JG STRAIGHT CONNECTION Ø8F-Ø8F	3	PZ																																																																																													
EL1440A0	WATER SELF CLEANING VALVE	4	PZ																																																																																													
GN1526A0	INT. D.=6.9 TH=1.8 O-RIN	9	PZ																																																																																													
RC1018A0	ZINC PLATED D12 ELASTIC CLAMP	2	PZ																																																																																													



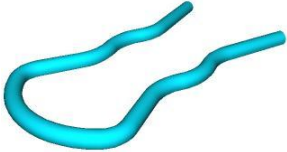

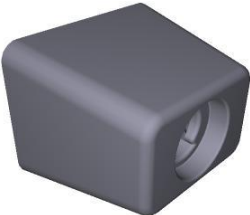
COMPONENT			SPARE PART																																																																																		
Code	Description	Image	Code	Description	Components list																																																																																
VL1186A	3 WAYS PLUS WASHING DISTRIBUTOR		KVL1184A	2 ROTOR ARMS PLUS EU CLEANING SYSTEM KIT	<table border="1"> <thead> <tr> <th>Code</th> <th>Description</th> <th>Qty</th> <th>UOM</th> </tr> </thead> <tbody> <tr> <td>RC1019A0</td> <td>D=10 ELASTIC CLAMP</td> <td>21</td> <td>PZ</td> </tr> <tr> <td>RC1130A0</td> <td>130X2,6 CLAM</td> <td>7</td> <td>PZ</td> </tr> <tr> <td>RC1131A0</td> <td>200X2,6 BLACK CLAMP</td> <td>3</td> <td>PZ</td> </tr> <tr> <td>RC1242A0</td> <td>D=10 CLOSED CAP</td> <td>2</td> <td>PZ</td> </tr> <tr> <td>RC1356A0</td> <td>"STRAIGHT THREADED FEMALE END 8X1/4" BS</td> <td>1</td> <td>PZ</td> </tr> <tr> <td>TB2820A0</td> <td>6X10 EPDM PIPE FOR WASHING SYSTEM</td> <td>2.400</td> <td>M</td> </tr> <tr> <td>TB3132A0</td> <td>WHITE-BLUE EPDM TEXTILE BRAID HOSE 6X12</td> <td>1.220</td> <td>M</td> </tr> <tr> <td>VL1019A0</td> <td>VIBRATION PUMP</td> <td>1</td> <td>PZ</td> </tr> <tr> <td>VL1046A1</td> <td>D6 PIPE HOLDER - D6 J.G. TERMINAL</td> <td>3</td> <td>PZ</td> </tr> <tr> <td>VL1047A1</td> <td>D6 PIPE HOLDER - D8 J.G. TERMINAL</td> <td>1</td> <td>PZ</td> </tr> <tr> <td>VL1065A1</td> <td>1/4 MALE N.O. PRESSURE SWITCH</td> <td>1</td> <td>PZ</td> </tr> <tr> <td>VL1067A0</td> <td>WASHING SYSTEM INLETS DISTRIBUTOR</td> <td>1</td> <td>PZ</td> </tr> <tr> <td>VL1092A0</td> <td>WASHING SYSTEM OUTLET DOUBLE DISTRIBUTOR</td> <td>1</td> <td>PZ</td> </tr> <tr> <td>VL1102A1</td> <td>DETERGENT LINE FILTER + BARBED VNR 6 MM</td> <td>1</td> <td>PZ</td> </tr> <tr> <td>VL1128A0</td> <td>D6 BARBED CHECK VALVE</td> <td>2</td> <td>PZ</td> </tr> <tr> <td>VL1128A1</td> <td>D6 BARBED CHECK VALVE</td> <td>2</td> <td>PZ</td> </tr> <tr> <td>VL1141A1</td> <td>STRAIGHT CONNECT BB6-BB6</td> <td>1</td> <td>PZ</td> </tr> <tr> <td>VL1165A0</td> <td>BB6-AR6 STRAIGHT FITTING</td> <td>4</td> <td>PZ</td> </tr> <tr> <td>VL1166A0</td> <td>BB6-AR6 L FITTING</td> <td>4</td> <td>PZ</td> </tr> </tbody> </table>	Code	Description	Qty	UOM	RC1019A0	D=10 ELASTIC CLAMP	21	PZ	RC1130A0	130X2,6 CLAM	7	PZ	RC1131A0	200X2,6 BLACK CLAMP	3	PZ	RC1242A0	D=10 CLOSED CAP	2	PZ	RC1356A0	"STRAIGHT THREADED FEMALE END 8X1/4" BS	1	PZ	TB2820A0	6X10 EPDM PIPE FOR WASHING SYSTEM	2.400	M	TB3132A0	WHITE-BLUE EPDM TEXTILE BRAID HOSE 6X12	1.220	M	VL1019A0	VIBRATION PUMP	1	PZ	VL1046A1	D6 PIPE HOLDER - D6 J.G. TERMINAL	3	PZ	VL1047A1	D6 PIPE HOLDER - D8 J.G. TERMINAL	1	PZ	VL1065A1	1/4 MALE N.O. PRESSURE SWITCH	1	PZ	VL1067A0	WASHING SYSTEM INLETS DISTRIBUTOR	1	PZ	VL1092A0	WASHING SYSTEM OUTLET DOUBLE DISTRIBUTOR	1	PZ	VL1102A1	DETERGENT LINE FILTER + BARBED VNR 6 MM	1	PZ	VL1128A0	D6 BARBED CHECK VALVE	2	PZ	VL1128A1	D6 BARBED CHECK VALVE	2	PZ	VL1141A1	STRAIGHT CONNECT BB6-BB6	1	PZ	VL1165A0	BB6-AR6 STRAIGHT FITTING	4	PZ	VL1166A0	BB6-AR6 L FITTING	4	PZ
Code	Description	Qty	UOM																																																																																		
RC1019A0	D=10 ELASTIC CLAMP	21	PZ																																																																																		
RC1130A0	130X2,6 CLAM	7	PZ																																																																																		
RC1131A0	200X2,6 BLACK CLAMP	3	PZ																																																																																		
RC1242A0	D=10 CLOSED CAP	2	PZ																																																																																		
RC1356A0	"STRAIGHT THREADED FEMALE END 8X1/4" BS	1	PZ																																																																																		
TB2820A0	6X10 EPDM PIPE FOR WASHING SYSTEM	2.400	M																																																																																		
TB3132A0	WHITE-BLUE EPDM TEXTILE BRAID HOSE 6X12	1.220	M																																																																																		
VL1019A0	VIBRATION PUMP	1	PZ																																																																																		
VL1046A1	D6 PIPE HOLDER - D6 J.G. TERMINAL	3	PZ																																																																																		
VL1047A1	D6 PIPE HOLDER - D8 J.G. TERMINAL	1	PZ																																																																																		
VL1065A1	1/4 MALE N.O. PRESSURE SWITCH	1	PZ																																																																																		
VL1067A0	WASHING SYSTEM INLETS DISTRIBUTOR	1	PZ																																																																																		
VL1092A0	WASHING SYSTEM OUTLET DOUBLE DISTRIBUTOR	1	PZ																																																																																		
VL1102A1	DETERGENT LINE FILTER + BARBED VNR 6 MM	1	PZ																																																																																		
VL1128A0	D6 BARBED CHECK VALVE	2	PZ																																																																																		
VL1128A1	D6 BARBED CHECK VALVE	2	PZ																																																																																		
VL1141A1	STRAIGHT CONNECT BB6-BB6	1	PZ																																																																																		
VL1165A0	BB6-AR6 STRAIGHT FITTING	4	PZ																																																																																		
VL1166A0	BB6-AR6 L FITTING	4	PZ																																																																																		

COMPONENT			SPARE PART																																																			
Code	Description	Image	Code	Description	Components list																																																	
VL1186A	3 WAYS PLUS WASHING DISTRIBUTOR		KVL1184A	2 ROTOR ARMS PLUS EU CLEANING SYSTEM KIT	<table border="1"> <thead> <tr> <th>Code</th> <th>Description</th> <th>Qty</th> <th>UOM</th> </tr> </thead> <tbody> <tr> <td>VL1174C0</td> <td>D1.2 MM CALIBRATED NOZZLE</td> <td>1</td> <td>PZ</td> </tr> <tr> <td>VL1186A0</td> <td>3 WAYS PLUS WASHING DISTRIBUTOR</td> <td>1</td> <td>PZ</td> </tr> <tr> <td>VL1190A0</td> <td>PLUS WASHING SYSTEM INLET DISTRIBUTOR</td> <td>1</td> <td>PZ</td> </tr> <tr> <td>VM1605A0</td> <td>CLIP TWIST LOCK DIAM. 10,2-12,7 MM</td> <td>4</td> <td>PZ</td> </tr> <tr> <td>VM2172A0</td> <td>PUMP-WITH-CI RCUIT LOCKING PIN</td> <td>9</td> <td>PZ</td> </tr> </tbody> </table>	Code	Description	Qty	UOM	VL1174C0	D1.2 MM CALIBRATED NOZZLE	1	PZ	VL1186A0	3 WAYS PLUS WASHING DISTRIBUTOR	1	PZ	VL1190A0	PLUS WASHING SYSTEM INLET DISTRIBUTOR	1	PZ	VM1605A0	CLIP TWIST LOCK DIAM. 10,2-12,7 MM	4	PZ	VM2172A0	PUMP-WITH-CI RCUIT LOCKING PIN	9	PZ																									
			Code	Description	Qty	UOM																																																
VL1174C0	D1.2 MM CALIBRATED NOZZLE	1	PZ																																																			
VL1186A0	3 WAYS PLUS WASHING DISTRIBUTOR	1	PZ																																																			
VL1190A0	PLUS WASHING SYSTEM INLET DISTRIBUTOR	1	PZ																																																			
VM1605A0	CLIP TWIST LOCK DIAM. 10,2-12,7 MM	4	PZ																																																			
VM2172A0	PUMP-WITH-CI RCUIT LOCKING PIN	9	PZ																																																			
KVL0684A	2-3 ROTOR ARM PLUS WASH PUMP+NOZZLE KIT	<table border="1"> <thead> <tr> <th>Code</th> <th>Description</th> <th>Qty</th> <th>UOM</th> </tr> </thead> <tbody> <tr> <td>GN1526A0</td> <td>INT. D.=6.9 TH=1.8 O-RIN</td> <td>4</td> <td>PZ</td> </tr> <tr> <td>RC1019A0</td> <td>D=10 ELASTIC CLAMP</td> <td>4</td> <td>PZ</td> </tr> <tr> <td>RC1130A0</td> <td>130X2,6 CLAM</td> <td>1</td> <td>PZ</td> </tr> <tr> <td>RC1131A0</td> <td>200X2,6 BLACK CLAMP</td> <td>3</td> <td>PZ</td> </tr> <tr> <td>RC1242A0</td> <td>D=10 CLOSED CAP</td> <td>2</td> <td>PZ</td> </tr> <tr> <td>TB2820A0</td> <td>6X10 EPDM PIPE FOR WASHING SYSTEM</td> <td>0.120</td> <td>M</td> </tr> <tr> <td>VL1019A0</td> <td>VIBRATION PUMP</td> <td>1</td> <td>PZ</td> </tr> <tr> <td>VL1128A1</td> <td>D6 BARBED CHECK VALVE</td> <td>1</td> <td>PZ</td> </tr> <tr> <td>VL1174C0</td> <td>D1.2 MM CALIBRATED NOZZLE</td> <td>1</td> <td>PZ</td> </tr> <tr> <td>VL1186A0</td> <td>3 WAYS PLUS WASHING DISTRIBUTOR</td> <td>1</td> <td>PZ</td> </tr> <tr> <td>VL1190A0</td> <td>PLUS WASHING SYSTEM INLET DISTRIBUTOR</td> <td>1</td> <td>PZ</td> </tr> <tr> <td>VM2172A0</td> <td>PUMP-WITH-CI RCUIT LOCKING PIN</td> <td>1</td> <td>PZ</td> </tr> </tbody> </table>	Code	Description	Qty	UOM	GN1526A0	INT. D.=6.9 TH=1.8 O-RIN	4	PZ	RC1019A0	D=10 ELASTIC CLAMP	4	PZ	RC1130A0	130X2,6 CLAM	1	PZ	RC1131A0	200X2,6 BLACK CLAMP	3	PZ	RC1242A0	D=10 CLOSED CAP	2	PZ	TB2820A0	6X10 EPDM PIPE FOR WASHING SYSTEM	0.120	M	VL1019A0	VIBRATION PUMP	1	PZ	VL1128A1	D6 BARBED CHECK VALVE	1	PZ	VL1174C0	D1.2 MM CALIBRATED NOZZLE	1	PZ	VL1186A0	3 WAYS PLUS WASHING DISTRIBUTOR	1	PZ	VL1190A0	PLUS WASHING SYSTEM INLET DISTRIBUTOR	1	PZ	VM2172A0	PUMP-WITH-CI RCUIT LOCKING PIN	1	PZ
Code	Description	Qty	UOM																																																			
GN1526A0	INT. D.=6.9 TH=1.8 O-RIN	4	PZ																																																			
RC1019A0	D=10 ELASTIC CLAMP	4	PZ																																																			
RC1130A0	130X2,6 CLAM	1	PZ																																																			
RC1131A0	200X2,6 BLACK CLAMP	3	PZ																																																			
RC1242A0	D=10 CLOSED CAP	2	PZ																																																			
TB2820A0	6X10 EPDM PIPE FOR WASHING SYSTEM	0.120	M																																																			
VL1019A0	VIBRATION PUMP	1	PZ																																																			
VL1128A1	D6 BARBED CHECK VALVE	1	PZ																																																			
VL1174C0	D1.2 MM CALIBRATED NOZZLE	1	PZ																																																			
VL1186A0	3 WAYS PLUS WASHING DISTRIBUTOR	1	PZ																																																			
VL1190A0	PLUS WASHING SYSTEM INLET DISTRIBUTOR	1	PZ																																																			
VM2172A0	PUMP-WITH-CI RCUIT LOCKING PIN	1	PZ																																																			







COMPONENT			SPARE PART																		
Code	Description	Image	Code	Description	Components list																
VM2172A	PUMP-WITH-CIRCUIT LOCKING PIN		VM2172A0	PUMP-WITH-CIRCUIT LOCKING PIN																	
VL1214A			VL1214A0																		
VM1630A	INTERNAL GLASS PUSHING CAP		KVM1630A	CAP FOR INTERNAL GLASS 10 PCS KIT	<table border="1"> <thead> <tr> <th>Code</th> <th>Description</th> <th>Qty</th> <th>UOM</th> </tr> </thead> <tbody> <tr> <td>VM1224A0</td> <td>65MY 220MM 2 COLOURS SHRINK TUBE</td> <td>0.200</td> <td>M</td> </tr> <tr> <td>VM1630A0</td> <td>INTERNAL GLASS PUSHING CAP</td> <td>10</td> <td>PZ</td> </tr> <tr> <td>VM1630A1</td> <td>INTERNAL GLASS PUSHING CAP</td> <td>10</td> <td>PZ</td> </tr> </tbody> </table>	Code	Description	Qty	UOM	VM1224A0	65MY 220MM 2 COLOURS SHRINK TUBE	0.200	M	VM1630A0	INTERNAL GLASS PUSHING CAP	10	PZ	VM1630A1	INTERNAL GLASS PUSHING CAP	10	PZ
Code	Description	Qty	UOM																		
VM1224A0	65MY 220MM 2 COLOURS SHRINK TUBE	0.200	M																		
VM1630A0	INTERNAL GLASS PUSHING CAP	10	PZ																		
VM1630A1	INTERNAL GLASS PUSHING CAP	10	PZ																		
VM1308B	BIG XEVL FRONT DOOR PUSHING PLATE		KVM1308B	BIG XEVL FRONT DOOR PUSHING PLATE KIT																	
VM1630A	INTERNAL GLASS PUSHING CAP		KVM1630A	CAP FOR INTERNAL GLASS 10 PCS KIT	<table border="1"> <thead> <tr> <th>Code</th> <th>Description</th> <th>Qty</th> <th>UOM</th> </tr> </thead> <tbody> <tr> <td>VM1224A0</td> <td>65MY 220MM 2 COLOURS SHRINK TUBE</td> <td>0.200</td> <td>M</td> </tr> <tr> <td>VM1630A0</td> <td>INTERNAL GLASS PUSHING CAP</td> <td>10</td> <td>PZ</td> </tr> <tr> <td>VM1630A1</td> <td>INTERNAL GLASS PUSHING CAP</td> <td>10</td> <td>PZ</td> </tr> </tbody> </table>	Code	Description	Qty	UOM	VM1224A0	65MY 220MM 2 COLOURS SHRINK TUBE	0.200	M	VM1630A0	INTERNAL GLASS PUSHING CAP	10	PZ	VM1630A1	INTERNAL GLASS PUSHING CAP	10	PZ
Code	Description	Qty	UOM																		
VM1224A0	65MY 220MM 2 COLOURS SHRINK TUBE	0.200	M																		
VM1630A0	INTERNAL GLASS PUSHING CAP	10	PZ																		
VM1630A1	INTERNAL GLASS PUSHING CAP	10	PZ																		

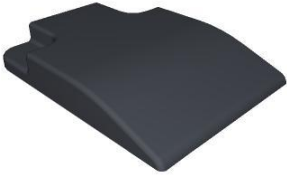

COMPONENT			SPARE PART																						
Code	Description	Image	Code	Description	Components list																				
VM1309B	BIG XEVL FRONT DOOR SLOTTED PUSHING PLAT		KVM1309A	BIG-L DOOR PUSHING BRACKET WITH HOLE KIT	<table border="1"> <thead> <tr> <th>Code</th> <th>Description</th> <th>Qty</th> <th>UOM</th> </tr> </thead> <tbody> <tr> <td>VI1220A1</td> <td>4,2X12 TCB SELF-TAPPIN G SCREW</td> <td>1</td> <td>PZ</td> </tr> <tr> <td>VM1224A0</td> <td>65MY 220MM 2 COLOURS SHRINK TUBE</td> <td>0.250</td> <td>M</td> </tr> <tr> <td>VM1309A0</td> <td>BIG DOOR PUSHING BRACKET WITH RING</td> <td>1</td> <td>PZ</td> </tr> <tr> <td>VM1631A0</td> <td>PLUS INNER GLASS PUSHING CAP</td> <td>1</td> <td>PZ</td> </tr> </tbody> </table>	Code	Description	Qty	UOM	VI1220A1	4,2X12 TCB SELF-TAPPIN G SCREW	1	PZ	VM1224A0	65MY 220MM 2 COLOURS SHRINK TUBE	0.250	M	VM1309A0	BIG DOOR PUSHING BRACKET WITH RING	1	PZ	VM1631A0	PLUS INNER GLASS PUSHING CAP	1	PZ
Code	Description	Qty	UOM																						
VI1220A1	4,2X12 TCB SELF-TAPPIN G SCREW	1	PZ																						
VM1224A0	65MY 220MM 2 COLOURS SHRINK TUBE	0.250	M																						
VM1309A0	BIG DOOR PUSHING BRACKET WITH RING	1	PZ																						
VM1631A0	PLUS INNER GLASS PUSHING CAP	1	PZ																						
0D2487B	XEVL-2011 RIGHT OPENING RIGHT SID		0D2487B0	XEVL-2011 RIGHT OPENING RIGHT SID																					
VM2612A	BIG S. HINGE PIN		VM2612A0	BIG S. HINGE PIN																					
VM2568A	BIG LEFT FRAME COVER		VM2568A0	BIG LEFT FRAME COVER																					
VM2569A	BIG RIGHT FRAME COVER		VM2569A0	BIG RIGHT FRAME COVER																					







COMPONENT			SPARE PART																						
Code	Description	Image	Code	Description	Components list																				
VM2559A	BIG DOOR HOLDING RAMP		KVM2559A	BIG-L DOOR SUPPORT RAMP KI	<table border="1"> <thead> <tr> <th>Code</th> <th>Description</th> <th>Qty</th> <th>UOM</th> </tr> </thead> <tbody> <tr> <td>VI1220A1</td> <td>4,2X12 TCB SELF-TAPPIN G SCREW</td> <td>2</td> <td>PZ</td> </tr> <tr> <td>VM1224A0</td> <td>65MY 220MM 2 COLOURS SHRINK TUBE</td> <td>0.010</td> <td>M</td> </tr> <tr> <td>VM2559A1</td> <td></td> <td>1</td> <td>PZ</td> </tr> <tr> <td>VM2559A2</td> <td>BIG DOOR HOLDING RAM</td> <td>1</td> <td>PZ</td> </tr> </tbody> </table>	Code	Description	Qty	UOM	VI1220A1	4,2X12 TCB SELF-TAPPIN G SCREW	2	PZ	VM1224A0	65MY 220MM 2 COLOURS SHRINK TUBE	0.010	M	VM2559A1		1	PZ	VM2559A2	BIG DOOR HOLDING RAM	1	PZ
Code	Description	Qty	UOM																						
VI1220A1	4,2X12 TCB SELF-TAPPIN G SCREW	2	PZ																						
VM1224A0	65MY 220MM 2 COLOURS SHRINK TUBE	0.010	M																						
VM2559A1		1	PZ																						
VM2559A2	BIG DOOR HOLDING RAM	1	PZ																						
VM2599A	BIG FRAME COVER CAP		VM2599A1	BIG FRAME COVER CAP																					
PD1011A			PD1011A0																						
VP1008A	TB 50 LEFT THREADED FOOT SUPPORT		KPD1011A	BIG-L FOOT KIT	<table border="1"> <thead> <tr> <th>Code</th> <th>Description</th> <th>Qty</th> <th>UOM</th> </tr> </thead> <tbody> <tr> <td>VM1224A0</td> <td>65MY 220MM 2 COLOURS SHRINK TUBE</td> <td>0.300</td> <td>M</td> </tr> <tr> <td>VP1008A0</td> <td>TB 50 LEFT THREADED FOOT SUPPORT</td> <td>1</td> <td>PZ</td> </tr> <tr> <td>VP1009A0</td> <td>TB 50 RIGHT THREADED FOOT SUPPORT</td> <td>1</td> <td>PZ</td> </tr> <tr> <td>VP1010A0</td> <td>THREADED FOOT FOR TB50</td> <td>1</td> <td>PZ</td> </tr> </tbody> </table>	Code	Description	Qty	UOM	VM1224A0	65MY 220MM 2 COLOURS SHRINK TUBE	0.300	M	VP1008A0	TB 50 LEFT THREADED FOOT SUPPORT	1	PZ	VP1009A0	TB 50 RIGHT THREADED FOOT SUPPORT	1	PZ	VP1010A0	THREADED FOOT FOR TB50	1	PZ
Code	Description	Qty	UOM																						
VM1224A0	65MY 220MM 2 COLOURS SHRINK TUBE	0.300	M																						
VP1008A0	TB 50 LEFT THREADED FOOT SUPPORT	1	PZ																						
VP1009A0	TB 50 RIGHT THREADED FOOT SUPPORT	1	PZ																						
VP1010A0	THREADED FOOT FOR TB50	1	PZ																						

COMPONENT			SPARE PART																						
Code	Description	Image	Code	Description	Components list																				
VP1009A	TB 50 RIGHT THREADED FOOT SUPPORT		KPD1011A	BIG-L FOOT KIT	<table border="1"> <thead> <tr> <th>Code</th> <th>Description</th> <th>Qty</th> <th>UOM</th> </tr> </thead> <tbody> <tr> <td>VM1224A0</td> <td>65MY 220MM 2 COLOURS SHRINK TUBE</td> <td>0.300</td> <td>M</td> </tr> <tr> <td>VP1008A0</td> <td>TB 50 LEFT THREADED FOOT SUPPORT</td> <td>1</td> <td>PZ</td> </tr> <tr> <td>VP1009A0</td> <td>TB 50 RIGHT THREADED FOOT SUPPORT</td> <td>1</td> <td>PZ</td> </tr> <tr> <td>VP1010A0</td> <td>THREADED FOOT FOR TB50</td> <td>1</td> <td>PZ</td> </tr> </tbody> </table>	Code	Description	Qty	UOM	VM1224A0	65MY 220MM 2 COLOURS SHRINK TUBE	0.300	M	VP1008A0	TB 50 LEFT THREADED FOOT SUPPORT	1	PZ	VP1009A0	TB 50 RIGHT THREADED FOOT SUPPORT	1	PZ	VP1010A0	THREADED FOOT FOR TB50	1	PZ
					Code	Description	Qty	UOM																	
					VM1224A0	65MY 220MM 2 COLOURS SHRINK TUBE	0.300	M																	
					VP1008A0	TB 50 LEFT THREADED FOOT SUPPORT	1	PZ																	
VP1009A0	TB 50 RIGHT THREADED FOOT SUPPORT	1	PZ																						
VP1010A0	THREADED FOOT FOR TB50	1	PZ																						
<table border="1"> <thead> <tr> <th>Code</th> <th>Description</th> <th>Qty</th> <th>UOM</th> </tr> </thead> <tbody> <tr> <td>VM1224A0</td> <td>65MY 220MM 2 COLOURS SHRINK TUBE</td> <td>0.300</td> <td>M</td> </tr> <tr> <td>VP1008A0</td> <td>TB 50 LEFT THREADED FOOT SUPPORT</td> <td>1</td> <td>PZ</td> </tr> <tr> <td>VP1009A0</td> <td>TB 50 RIGHT THREADED FOOT SUPPORT</td> <td>1</td> <td>PZ</td> </tr> <tr> <td>VP1010A0</td> <td>THREADED FOOT FOR TB50</td> <td>1</td> <td>PZ</td> </tr> </tbody> </table>	Code	Description	Qty	UOM	VM1224A0	65MY 220MM 2 COLOURS SHRINK TUBE	0.300	M	VP1008A0	TB 50 LEFT THREADED FOOT SUPPORT	1	PZ	VP1009A0	TB 50 RIGHT THREADED FOOT SUPPORT	1	PZ	VP1010A0	THREADED FOOT FOR TB50	1	PZ					
Code	Description	Qty	UOM																						
VM1224A0	65MY 220MM 2 COLOURS SHRINK TUBE	0.300	M																						
VP1008A0	TB 50 LEFT THREADED FOOT SUPPORT	1	PZ																						
VP1009A0	TB 50 RIGHT THREADED FOOT SUPPORT	1	PZ																						
VP1010A0	THREADED FOOT FOR TB50	1	PZ																						
<table border="1"> <thead> <tr> <th>Code</th> <th>Description</th> <th>Qty</th> <th>UOM</th> </tr> </thead> <tbody> <tr> <td>VM1224A0</td> <td>65MY 220MM 2 COLOURS SHRINK TUBE</td> <td>0.300</td> <td>M</td> </tr> <tr> <td>VP1008A0</td> <td>TB 50 LEFT THREADED FOOT SUPPORT</td> <td>1</td> <td>PZ</td> </tr> <tr> <td>VP1009A0</td> <td>TB 50 RIGHT THREADED FOOT SUPPORT</td> <td>1</td> <td>PZ</td> </tr> <tr> <td>VP1010A0</td> <td>THREADED FOOT FOR TB50</td> <td>1</td> <td>PZ</td> </tr> </tbody> </table>	Code	Description	Qty	UOM	VM1224A0	65MY 220MM 2 COLOURS SHRINK TUBE	0.300	M	VP1008A0	TB 50 LEFT THREADED FOOT SUPPORT	1	PZ	VP1009A0	TB 50 RIGHT THREADED FOOT SUPPORT	1	PZ	VP1010A0	THREADED FOOT FOR TB50	1	PZ					
Code	Description	Qty	UOM																						
VM1224A0	65MY 220MM 2 COLOURS SHRINK TUBE	0.300	M																						
VP1008A0	TB 50 LEFT THREADED FOOT SUPPORT	1	PZ																						
VP1009A0	TB 50 RIGHT THREADED FOOT SUPPORT	1	PZ																						
VP1010A0	THREADED FOOT FOR TB50	1	PZ																						
<table border="1"> <thead> <tr> <th>Code</th> <th>Description</th> <th>Qty</th> <th>UOM</th> </tr> </thead> <tbody> <tr> <td>VM1224A0</td> <td>65MY 220MM 2 COLOURS SHRINK TUBE</td> <td>0.300</td> <td>M</td> </tr> <tr> <td>VP1008A0</td> <td>TB 50 LEFT THREADED FOOT SUPPORT</td> <td>1</td> <td>PZ</td> </tr> <tr> <td>VP1009A0</td> <td>TB 50 RIGHT THREADED FOOT SUPPORT</td> <td>1</td> <td>PZ</td> </tr> <tr> <td>VP1010A0</td> <td>THREADED FOOT FOR TB50</td> <td>1</td> <td>PZ</td> </tr> </tbody> </table>	Code	Description	Qty	UOM	VM1224A0	65MY 220MM 2 COLOURS SHRINK TUBE	0.300	M	VP1008A0	TB 50 LEFT THREADED FOOT SUPPORT	1	PZ	VP1009A0	TB 50 RIGHT THREADED FOOT SUPPORT	1	PZ	VP1010A0	THREADED FOOT FOR TB50	1	PZ					
Code	Description	Qty	UOM																						
VM1224A0	65MY 220MM 2 COLOURS SHRINK TUBE	0.300	M																						
VP1008A0	TB 50 LEFT THREADED FOOT SUPPORT	1	PZ																						
VP1009A0	TB 50 RIGHT THREADED FOOT SUPPORT	1	PZ																						
VP1010A0	THREADED FOOT FOR TB50	1	PZ																						
VP1010A	THREADED FOOT FOR TB50		KPD1011A	BIG-L FOOT KIT	<table border="1"> <thead> <tr> <th>Code</th> <th>Description</th> <th>Qty</th> <th>UOM</th> </tr> </thead> <tbody> <tr> <td>VM1224A0</td> <td>65MY 220MM 2 COLOURS SHRINK TUBE</td> <td>0.300</td> <td>M</td> </tr> <tr> <td>VP1008A0</td> <td>TB 50 LEFT THREADED FOOT SUPPORT</td> <td>1</td> <td>PZ</td> </tr> <tr> <td>VP1009A0</td> <td>TB 50 RIGHT THREADED FOOT SUPPORT</td> <td>1</td> <td>PZ</td> </tr> <tr> <td>VP1010A0</td> <td>THREADED FOOT FOR TB50</td> <td>1</td> <td>PZ</td> </tr> </tbody> </table>	Code	Description	Qty	UOM	VM1224A0	65MY 220MM 2 COLOURS SHRINK TUBE	0.300	M	VP1008A0	TB 50 LEFT THREADED FOOT SUPPORT	1	PZ	VP1009A0	TB 50 RIGHT THREADED FOOT SUPPORT	1	PZ	VP1010A0	THREADED FOOT FOR TB50	1	PZ
					Code	Description	Qty	UOM																	
VM1224A0	65MY 220MM 2 COLOURS SHRINK TUBE	0.300	M																						
VP1008A0	TB 50 LEFT THREADED FOOT SUPPORT	1	PZ																						
VP1009A0	TB 50 RIGHT THREADED FOOT SUPPORT	1	PZ																						
VP1010A0	THREADED FOOT FOR TB50	1	PZ																						
<table border="1"> <thead> <tr> <th>Code</th> <th>Description</th> <th>Qty</th> <th>UOM</th> </tr> </thead> <tbody> <tr> <td>VM1224A0</td> <td>65MY 220MM 2 COLOURS SHRINK TUBE</td> <td>0.300</td> <td>M</td> </tr> <tr> <td>VP1008A0</td> <td>TB 50 LEFT THREADED FOOT SUPPORT</td> <td>1</td> <td>PZ</td> </tr> <tr> <td>VP1009A0</td> <td>TB 50 RIGHT THREADED FOOT SUPPORT</td> <td>1</td> <td>PZ</td> </tr> <tr> <td>VP1010A0</td> <td>THREADED FOOT FOR TB50</td> <td>1</td> <td>PZ</td> </tr> </tbody> </table>	Code	Description	Qty	UOM	VM1224A0	65MY 220MM 2 COLOURS SHRINK TUBE	0.300	M	VP1008A0	TB 50 LEFT THREADED FOOT SUPPORT	1	PZ	VP1009A0	TB 50 RIGHT THREADED FOOT SUPPORT	1	PZ	VP1010A0	THREADED FOOT FOR TB50	1	PZ					
Code	Description	Qty	UOM																						
VM1224A0	65MY 220MM 2 COLOURS SHRINK TUBE	0.300	M																						
VP1008A0	TB 50 LEFT THREADED FOOT SUPPORT	1	PZ																						
VP1009A0	TB 50 RIGHT THREADED FOOT SUPPORT	1	PZ																						
VP1010A0	THREADED FOOT FOR TB50	1	PZ																						
VM2556B	RIGHT OPENING BIG OVENS LOWER FULCRUM		KVM2556B	BIG-L RIGHT LOWER FULCRUM KIT	<table border="1"> <thead> <tr> <th>Code</th> <th>Description</th> <th>Qty</th> <th>UOM</th> </tr> </thead> <tbody> <tr> <td>VM1224A0</td> <td>65MY 220MM 2 COLOURS SHRINK TUBE</td> <td>0.250</td> <td>M</td> </tr> <tr> <td>VM2556B0</td> <td>RIGHT OPENING BIG OVENS LOWER FULCRUM</td> <td>1</td> <td>PZ</td> </tr> </tbody> </table>	Code	Description	Qty	UOM	VM1224A0	65MY 220MM 2 COLOURS SHRINK TUBE	0.250	M	VM2556B0	RIGHT OPENING BIG OVENS LOWER FULCRUM	1	PZ								
					Code	Description	Qty	UOM																	
VM1224A0	65MY 220MM 2 COLOURS SHRINK TUBE	0.250	M																						
VM2556B0	RIGHT OPENING BIG OVENS LOWER FULCRUM	1	PZ																						
<table border="1"> <thead> <tr> <th>Code</th> <th>Description</th> <th>Qty</th> <th>UOM</th> </tr> </thead> <tbody> <tr> <td>VM1224A0</td> <td>65MY 220MM 2 COLOURS SHRINK TUBE</td> <td>0.250</td> <td>M</td> </tr> <tr> <td>VM2556B0</td> <td>RIGHT OPENING BIG OVENS LOWER FULCRUM</td> <td>1</td> <td>PZ</td> </tr> </tbody> </table>	Code	Description	Qty	UOM	VM1224A0	65MY 220MM 2 COLOURS SHRINK TUBE	0.250	M	VM2556B0	RIGHT OPENING BIG OVENS LOWER FULCRUM	1	PZ													
Code	Description	Qty	UOM																						
VM1224A0	65MY 220MM 2 COLOURS SHRINK TUBE	0.250	M																						
VM2556B0	RIGHT OPENING BIG OVENS LOWER FULCRUM	1	PZ																						
VP1063A			VP1063A0																						

COMPONENT			SPARE PART																										
Code	Description	Image	Code	Description	Components list																								
VP1064A			VP1064A0																										
VM1750A	BASS COMB CLAM		KVM1750A	COMB TERMINAL BLOCK KIT	<table border="1"> <thead> <tr> <th>Code</th> <th>Description</th> <th>Qty</th> <th>UOM</th> </tr> </thead> <tbody> <tr> <td>VM1224A0</td> <td>65MY 220MM 2 COLOURS SHRINK TUBE</td> <td>0.150</td> <td>M</td> </tr> <tr> <td>VM1750A0</td> <td>BASS COMB CLAMP</td> <td>1</td> <td>PZ</td> </tr> </tbody> </table>	Code	Description	Qty	UOM	VM1224A0	65MY 220MM 2 COLOURS SHRINK TUBE	0.150	M	VM1750A0	BASS COMB CLAMP	1	PZ												
Code	Description	Qty	UOM																										
VM1224A0	65MY 220MM 2 COLOURS SHRINK TUBE	0.150	M																										
VM1750A0	BASS COMB CLAMP	1	PZ																										
VM1505A	WALL PASSING WITH DIAPHRAGM		KVM1505A	THROUGH-WALL CONNECTION+DIAPHRAGM KIT	<table border="1"> <thead> <tr> <th>Code</th> <th>Description</th> <th>Qty</th> <th>UOM</th> </tr> </thead> <tbody> <tr> <td>VI1220A1</td> <td>4,2X12 TCB SELF-TAPPIN G.SCREW</td> <td>1</td> <td>PZ</td> </tr> <tr> <td>VM1224A0</td> <td>65MY 220MM 2 COLOURS SHRINK TUBE</td> <td>0.200</td> <td>M</td> </tr> <tr> <td>VM1505A0</td> <td>WALL PASSING WITH DIAPHRAGM</td> <td>3</td> <td>PZ</td> </tr> <tr> <td>VM2055A0</td> <td>UPPER WALL PASSING ACCESSORY CABLES</td> <td>1</td> <td>PZ</td> </tr> <tr> <td>VM2056A0</td> <td>LOWER WALL PASSING ACCESSORY CABLES</td> <td>1</td> <td>PZ</td> </tr> </tbody> </table>	Code	Description	Qty	UOM	VI1220A1	4,2X12 TCB SELF-TAPPIN G.SCREW	1	PZ	VM1224A0	65MY 220MM 2 COLOURS SHRINK TUBE	0.200	M	VM1505A0	WALL PASSING WITH DIAPHRAGM	3	PZ	VM2055A0	UPPER WALL PASSING ACCESSORY CABLES	1	PZ	VM2056A0	LOWER WALL PASSING ACCESSORY CABLES	1	PZ
Code	Description	Qty	UOM																										
VI1220A1	4,2X12 TCB SELF-TAPPIN G.SCREW	1	PZ																										
VM1224A0	65MY 220MM 2 COLOURS SHRINK TUBE	0.200	M																										
VM1505A0	WALL PASSING WITH DIAPHRAGM	3	PZ																										
VM2055A0	UPPER WALL PASSING ACCESSORY CABLES	1	PZ																										
VM2056A0	LOWER WALL PASSING ACCESSORY CABLES	1	PZ																										
VE1628A	REDUCED STRAIN RELIEF PG 48		KVE1628A	CABLE GLAND + PG 48 NUT KIT																									

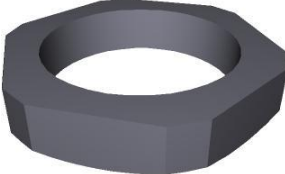

COMPONENT			SPARE PART																		
Code	Description	Image	Code	Description	Components list																
VE1629A	STRAIN RELIEF NUT PG 48		VE1629A0	STRAIN RELIEF NUT PG 48																	
VI1111A	ST.STEEL TSIC M6X12 SCREW		VI1111A1	ST.STEEL TSIC M6X12 SCREW																	
VE1575A	NUT WITH COLLAR FOR WIRE CLAMP M25		OUTOFPRODUCTIO	ITEM OUT OF PRODUCTION																	
VM2249A	COOKING CHAMBER FRONT CORNER		KVM2249A	CHAMBER FRONT PROFILE CORNER KIT	<table border="1"> <thead> <tr> <th>Code</th> <th>Description</th> <th>Qty</th> <th>UOM</th> </tr> </thead> <tbody> <tr> <td>VM1224A0</td> <td>65MY 220MM 2 COLOURS SHRINK TUBE</td> <td>0.150</td> <td>M</td> </tr> <tr> <td>VM2249A0</td> <td>COOKING CHAMBER FRONT CORNER</td> <td>1</td> <td>PZ</td> </tr> </tbody> </table>	Code	Description	Qty	UOM	VM1224A0	65MY 220MM 2 COLOURS SHRINK TUBE	0.150	M	VM2249A0	COOKING CHAMBER FRONT CORNER	1	PZ				
Code	Description	Qty	UOM																		
VM1224A0	65MY 220MM 2 COLOURS SHRINK TUBE	0.150	M																		
VM2249A0	COOKING CHAMBER FRONT CORNER	1	PZ																		
TR1161A	350°C UNIPOLAR SAFETY THERMOSTAT		KTR1161A	350°C SAFETY THERMOSTAT KIT	<table border="1"> <thead> <tr> <th>Code</th> <th>Description</th> <th>Qty</th> <th>UOM</th> </tr> </thead> <tbody> <tr> <td>0H2163B0</td> <td>TR1161 SAFETY THERMOSTAT BULB HOLDER</td> <td>1</td> <td>PZ</td> </tr> <tr> <td>TR1161A0</td> <td></td> <td>1</td> <td>PZ</td> </tr> <tr> <td>TR1161A1</td> <td>350°C UNIPOLAR SAFETY THERMOSTAT</td> <td>1</td> <td>PZ</td> </tr> </tbody> </table>	Code	Description	Qty	UOM	0H2163B0	TR1161 SAFETY THERMOSTAT BULB HOLDER	1	PZ	TR1161A0		1	PZ	TR1161A1	350°C UNIPOLAR SAFETY THERMOSTAT	1	PZ
Code	Description	Qty	UOM																		
0H2163B0	TR1161 SAFETY THERMOSTAT BULB HOLDER	1	PZ																		
TR1161A0		1	PZ																		
TR1161A1	350°C UNIPOLAR SAFETY THERMOSTAT	1	PZ																		