







Assembly code	Assembly revision	Assembly image
ASM4080A/0.D00	Door	
ASM2110A/0.D00	External cover	
ASM2794A/0.D00	General overview	
ASM4101A/0.D01	General overview	
ASM2109B/0.D01	Cooking chamber	

**ASM4080A/0.D00 - Door**





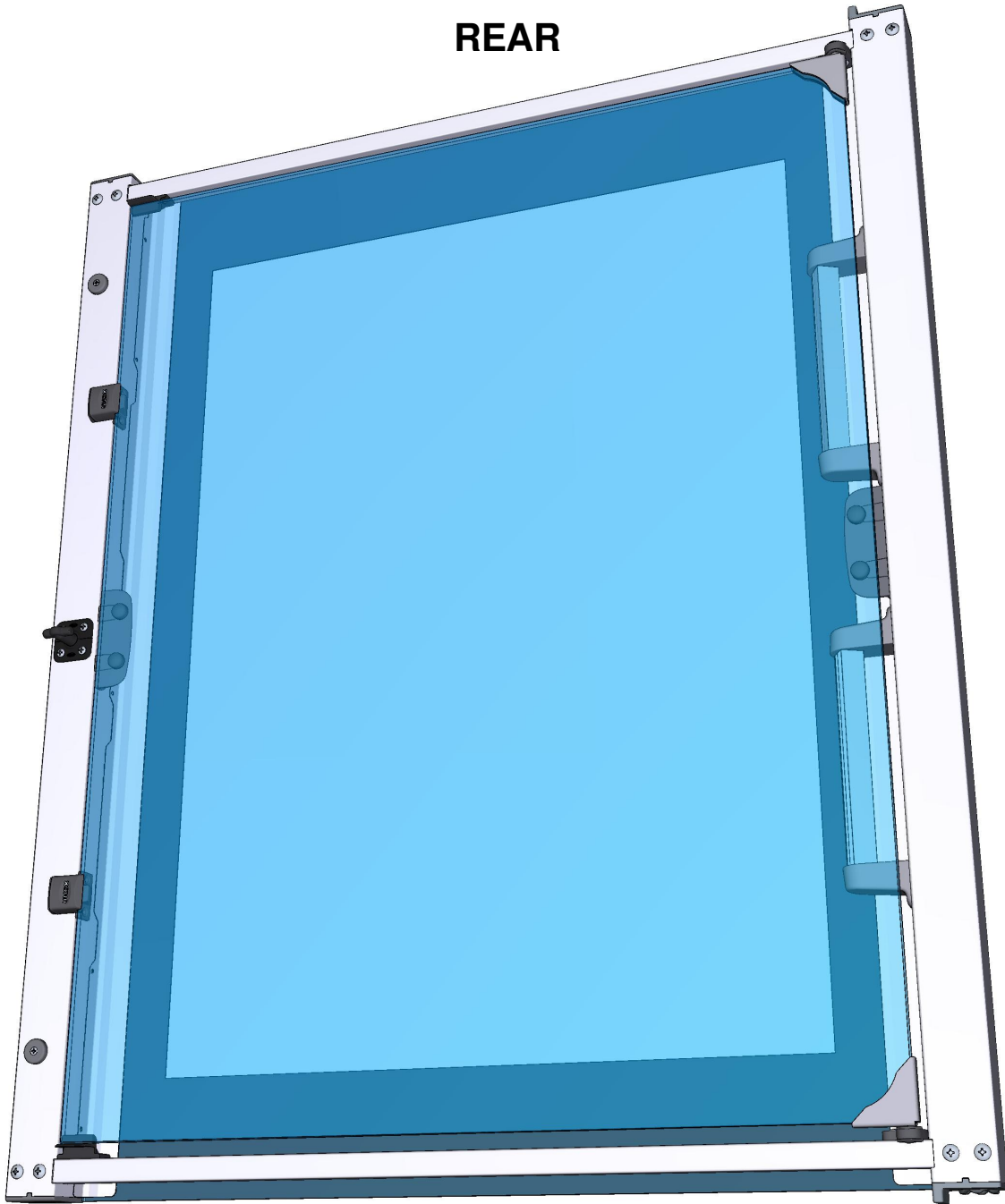

ASM4080A/0.D00 - Door

REAR







COMPONENT			SPARE PART																										
Code	Description	Image	Code	Description	Components list																								
VM1630A	INTERNAL GLASS PUSHING CAP		KVM1630A	CAP FOR INTERNAL GLASS 10 PCS KIT	<table border="1"> <thead> <tr> <th>Code</th> <th>Description</th> <th>Qty</th> <th>UOM</th> </tr> </thead> <tbody> <tr> <td>VM1224A0</td> <td>65MY 220MM 2 COLOURS SHRINK TUBE</td> <td>0.200</td> <td>M</td> </tr> <tr> <td>VM1630A0</td> <td>INTERNAL GLASS PUSHING CAP</td> <td>10</td> <td>PZ</td> </tr> <tr> <td>VM1630A1</td> <td>INTERNAL GLASS PUSHING CAP</td> <td>10</td> <td>PZ</td> </tr> </tbody> </table>	Code	Description	Qty	UOM	VM1224A0	65MY 220MM 2 COLOURS SHRINK TUBE	0.200	M	VM1630A0	INTERNAL GLASS PUSHING CAP	10	PZ	VM1630A1	INTERNAL GLASS PUSHING CAP	10	PZ								
Code	Description	Qty	UOM																										
VM1224A0	65MY 220MM 2 COLOURS SHRINK TUBE	0.200	M																										
VM1630A0	INTERNAL GLASS PUSHING CAP	10	PZ																										
VM1630A1	INTERNAL GLASS PUSHING CAP	10	PZ																										
VM1591A	GLASS BRACKET INT. XVC1004		KVM1591A	S.5E INT. GLASS H35 PUSHING BRACKET KIT	<table border="1"> <thead> <tr> <th>Code</th> <th>Description</th> <th>Qty</th> <th>UOM</th> </tr> </thead> <tbody> <tr> <td>VI1220A1</td> <td>4,2X12 TCB SELF-TAPPIN G SCREW</td> <td>2</td> <td>PZ</td> </tr> <tr> <td>VM1224A0</td> <td>65MY 220MM 2 COLOURS SHRINK TUBE</td> <td>0.200</td> <td>M</td> </tr> <tr> <td>VM1591A0</td> <td>GLASS BRACKET INT. XVC1004</td> <td>1</td> <td>PZ</td> </tr> <tr> <td>VM1630A0</td> <td>INTERNAL GLASS PUSHING CAP</td> <td>2</td> <td>PZ</td> </tr> <tr> <td>VM1630A1</td> <td>INTERNAL GLASS PUSHING CAP</td> <td>2</td> <td>PZ</td> </tr> </tbody> </table>	Code	Description	Qty	UOM	VI1220A1	4,2X12 TCB SELF-TAPPIN G SCREW	2	PZ	VM1224A0	65MY 220MM 2 COLOURS SHRINK TUBE	0.200	M	VM1591A0	GLASS BRACKET INT. XVC1004	1	PZ	VM1630A0	INTERNAL GLASS PUSHING CAP	2	PZ	VM1630A1	INTERNAL GLASS PUSHING CAP	2	PZ
Code	Description	Qty	UOM																										
VI1220A1	4,2X12 TCB SELF-TAPPIN G SCREW	2	PZ																										
VM1224A0	65MY 220MM 2 COLOURS SHRINK TUBE	0.200	M																										
VM1591A0	GLASS BRACKET INT. XVC1004	1	PZ																										
VM1630A0	INTERNAL GLASS PUSHING CAP	2	PZ																										
VM1630A1	INTERNAL GLASS PUSHING CAP	2	PZ																										
VM1511A	XBC/XVC SLEEK DOOR PIN BUSHING		KVM1511A	5 PCS SLEEK DOOR PIN BUSHING KIT	<table border="1"> <thead> <tr> <th>Code</th> <th>Description</th> <th>Qty</th> <th>UOM</th> </tr> </thead> <tbody> <tr> <td>VM1224A0</td> <td>65MY 220MM 2 COLOURS SHRINK TUBE</td> <td>0.200</td> <td>M</td> </tr> <tr> <td>VM1511A0</td> <td>XBC/XVC SLEEK DOOR PIN BUSHING</td> <td>5</td> <td>PZ</td> </tr> </tbody> </table>	Code	Description	Qty	UOM	VM1224A0	65MY 220MM 2 COLOURS SHRINK TUBE	0.200	M	VM1511A0	XBC/XVC SLEEK DOOR PIN BUSHING	5	PZ												
Code	Description	Qty	UOM																										
VM1224A0	65MY 220MM 2 COLOURS SHRINK TUBE	0.200	M																										
VM1511A0	XBC/XVC SLEEK DOOR PIN BUSHING	5	PZ																										
VM1510A	XBC/XVC GROOVED DOOR PIN BUSHING		KVM1510A	GROOVED DOOR PIN BUSHING 5 PCS KIT	<table border="1"> <thead> <tr> <th>Code</th> <th>Description</th> <th>Qty</th> <th>UOM</th> </tr> </thead> <tbody> <tr> <td>VM1224A0</td> <td>65MY 220MM 2 COLOURS SHRINK TUBE</td> <td>0.150</td> <td>M</td> </tr> <tr> <td>VM1510A0</td> <td>XBC/XVC GROOVED DOOR PIN BUSHING</td> <td>5</td> <td>PZ</td> </tr> </tbody> </table>	Code	Description	Qty	UOM	VM1224A0	65MY 220MM 2 COLOURS SHRINK TUBE	0.150	M	VM1510A0	XBC/XVC GROOVED DOOR PIN BUSHING	5	PZ												
Code	Description	Qty	UOM																										
VM1224A0	65MY 220MM 2 COLOURS SHRINK TUBE	0.150	M																										
VM1510A0	XBC/XVC GROOVED DOOR PIN BUSHING	5	PZ																										

COMPONENT			SPARE PART																																						
Code	Description	Image	Code	Description	Components list																																				
TB2384B	BAKERLUX CHEFLUX DOOR UPPER LISTEL		TB2384B0	BAKERLUX CHEFLUX DOOR UPPER LISTEL																																					
TB2404A	BAKERLUX CHEFLUX DOOR LOWER LISTEL		TB2404A0	BAKERLUX CHEFLUX DOOR LOWER LISTEL																																					
VM1977A	CL BL DOOR UPPER FULCRUM-CAP		KVM1977A	CL BL DOOR UPPER FULCRUM-CAP KIT	<table border="1"> <thead> <tr> <th>Code</th> <th>Description</th> <th>Qty</th> <th>UOM</th> </tr> </thead> <tbody> <tr> <td>VM1224A0</td> <td>65MY 220MM 2 COLOURS SHRINK TUBE</td> <td>0.250</td> <td>M</td> </tr> <tr> <td>VM1977A0</td> <td>CL BL DOOR UPPER FULCRUM-CA</td> <td>1</td> <td>PZ</td> </tr> </tbody> </table>	Code	Description	Qty	UOM	VM1224A0	65MY 220MM 2 COLOURS SHRINK TUBE	0.250	M	VM1977A0	CL BL DOOR UPPER FULCRUM-CA	1	PZ																								
Code	Description	Qty	UOM																																						
VM1224A0	65MY 220MM 2 COLOURS SHRINK TUBE	0.250	M																																						
VM1977A0	CL BL DOOR UPPER FULCRUM-CA	1	PZ																																						
VM1978A	CL BL DOOR LOWER FULCRUM-CAP		KDR1254A	XB893 XV893 COMPLETE DOOR	<table border="1"> <thead> <tr> <th>Code</th> <th>Description</th> <th>Qty</th> <th>UOM</th> </tr> </thead> <tbody> <tr> <td>0H6575A1</td> <td>XB89- XV EXTERNAL GLASS HOLDING PROFILE</td> <td>2</td> <td>PZ</td> </tr> <tr> <td>0H7321A0</td> <td>MM STAINLESS STEEL HANDLE COVE</td> <td>1</td> <td>PZ</td> </tr> <tr> <td>CR1085A0</td> <td>INTERNAL GLASS UPPER HINGE</td> <td>1</td> <td>PZ</td> </tr> <tr> <td>CR1086A0</td> <td>INTERNAL GLASS LOWER HINGE</td> <td>1</td> <td>PZ</td> </tr> <tr> <td>ED1072A0</td> <td></td> <td>1</td> <td>PZ</td> </tr> <tr> <td>GN1181A0</td> <td>INTERNAL GLASS HINGE SEAL</td> <td>2</td> <td>PZ</td> </tr> <tr> <td>IL1206C0</td> <td>968X1053 H126 XBC WOOD PALLE</td> <td>1</td> <td>PZ</td> </tr> <tr> <td>IL1206D0</td> <td></td> <td>1</td> <td>PZ</td> </tr> </tbody> </table>	Code	Description	Qty	UOM	0H6575A1	XB89- XV EXTERNAL GLASS HOLDING PROFILE	2	PZ	0H7321A0	MM STAINLESS STEEL HANDLE COVE	1	PZ	CR1085A0	INTERNAL GLASS UPPER HINGE	1	PZ	CR1086A0	INTERNAL GLASS LOWER HINGE	1	PZ	ED1072A0		1	PZ	GN1181A0	INTERNAL GLASS HINGE SEAL	2	PZ	IL1206C0	968X1053 H126 XBC WOOD PALLE	1	PZ	IL1206D0		1	PZ
Code	Description	Qty	UOM																																						
0H6575A1	XB89- XV EXTERNAL GLASS HOLDING PROFILE	2	PZ																																						
0H7321A0	MM STAINLESS STEEL HANDLE COVE	1	PZ																																						
CR1085A0	INTERNAL GLASS UPPER HINGE	1	PZ																																						
CR1086A0	INTERNAL GLASS LOWER HINGE	1	PZ																																						
ED1072A0		1	PZ																																						
GN1181A0	INTERNAL GLASS HINGE SEAL	2	PZ																																						
IL1206C0	968X1053 H126 XBC WOOD PALLE	1	PZ																																						
IL1206D0		1	PZ																																						





COMPONENT			SPARE PART																																																																						
Code	Description	Image	Code	Description	Components list																																																																				
VM1978A	CL BL DOOR LOWER FULCRUM-CAP		KDR1254A	XB893 XV893 COMPLETE DOOR	<table border="1"> <thead> <tr> <th>Code</th> <th>Description</th> <th>Qty</th> <th>UOM</th> </tr> </thead> <tbody> <tr> <td>MG1030B2</td> <td>CT-BT DOOR HANDLE</td> <td>1</td> <td>PZ</td> </tr> <tr> <td>RC1200A0</td> <td>ED=4 WIRE D.=0.5 COMPRESSIO N SPRING</td> <td>8</td> <td>PZ</td> </tr> <tr> <td>SL1110A0</td> <td>BIADHESIVE PIN 3M VHB 9473-PC</td> <td>1</td> <td>PZ</td> </tr> <tr> <td>TB2384B0</td> <td>BAKERLUX CHEFLUX DOOR UPPER LISTEL</td> <td>1</td> <td>PZ</td> </tr> <tr> <td>TB2385A0</td> <td>BL CL 89- RIGHT DOOR COLUMN 50X50X1.2</td> <td>1</td> <td>PZ</td> </tr> <tr> <td>TB2386A0</td> <td>BL CL 89- LEFT DOOR COLUMN 50X50X1.2</td> <td>1</td> <td>PZ</td> </tr> <tr> <td>TB2404A0</td> <td>BAKERLUX CHEFLUX DOOR LOWER LISTEL</td> <td>1</td> <td>PZ</td> </tr> <tr> <td>VI0239A1</td> <td>SELF-TAPPIN G SCREW 4.2X25 TCB+ INOX</td> <td>4</td> <td>PZ</td> </tr> <tr> <td>VI1070A0</td> <td>SCREW M4X16 TSP/UNI7688 INOX</td> <td>1</td> <td>PZ</td> </tr> <tr> <td>VI1075A0</td> <td>NUT M4 H=4 UNI5587 INOX</td> <td>1</td> <td>PZ</td> </tr> <tr> <td>VI1220A1</td> <td>4,2X12 TCB SELF-TAPPIN G SCREW</td> <td>28</td> <td>PZ</td> </tr> <tr> <td>VI1300A0</td> <td>SCREW M6X12 T1/2T+INOX</td> <td>12</td> <td>PZ</td> </tr> <tr> <td>VI1310A0</td> <td>ZINC THREAD INSERT M6 FTR/E</td> <td>8</td> <td>PZ</td> </tr> <tr> <td>VI1340A0</td> <td>M6 ST. STEEL THREADED INSERT</td> <td>4</td> <td>PZ</td> </tr> <tr> <td>VI1810A0</td> <td>M6X6 STAINLESS STEEL FLATHEAD SCREW</td> <td>6</td> <td>PZ</td> </tr> <tr> <td>VM1182B1</td> <td>E.S. CT BT HANDLE JUNCTION + PIN GUIDE</td> <td>1</td> <td>PZ</td> </tr> </tbody> </table>	Code	Description	Qty	UOM	MG1030B2	CT-BT DOOR HANDLE	1	PZ	RC1200A0	ED=4 WIRE D.=0.5 COMPRESSIO N SPRING	8	PZ	SL1110A0	BIADHESIVE PIN 3M VHB 9473-PC	1	PZ	TB2384B0	BAKERLUX CHEFLUX DOOR UPPER LISTEL	1	PZ	TB2385A0	BL CL 89- RIGHT DOOR COLUMN 50X50X1.2	1	PZ	TB2386A0	BL CL 89- LEFT DOOR COLUMN 50X50X1.2	1	PZ	TB2404A0	BAKERLUX CHEFLUX DOOR LOWER LISTEL	1	PZ	VI0239A1	SELF-TAPPIN G SCREW 4.2X25 TCB+ INOX	4	PZ	VI1070A0	SCREW M4X16 TSP/UNI7688 INOX	1	PZ	VI1075A0	NUT M4 H=4 UNI5587 INOX	1	PZ	VI1220A1	4,2X12 TCB SELF-TAPPIN G SCREW	28	PZ	VI1300A0	SCREW M6X12 T1/2T+INOX	12	PZ	VI1310A0	ZINC THREAD INSERT M6 FTR/E	8	PZ	VI1340A0	M6 ST. STEEL THREADED INSERT	4	PZ	VI1810A0	M6X6 STAINLESS STEEL FLATHEAD SCREW	6	PZ	VM1182B1	E.S. CT BT HANDLE JUNCTION + PIN GUIDE	1	PZ
Code	Description	Qty	UOM																																																																						
MG1030B2	CT-BT DOOR HANDLE	1	PZ																																																																						
RC1200A0	ED=4 WIRE D.=0.5 COMPRESSIO N SPRING	8	PZ																																																																						
SL1110A0	BIADHESIVE PIN 3M VHB 9473-PC	1	PZ																																																																						
TB2384B0	BAKERLUX CHEFLUX DOOR UPPER LISTEL	1	PZ																																																																						
TB2385A0	BL CL 89- RIGHT DOOR COLUMN 50X50X1.2	1	PZ																																																																						
TB2386A0	BL CL 89- LEFT DOOR COLUMN 50X50X1.2	1	PZ																																																																						
TB2404A0	BAKERLUX CHEFLUX DOOR LOWER LISTEL	1	PZ																																																																						
VI0239A1	SELF-TAPPIN G SCREW 4.2X25 TCB+ INOX	4	PZ																																																																						
VI1070A0	SCREW M4X16 TSP/UNI7688 INOX	1	PZ																																																																						
VI1075A0	NUT M4 H=4 UNI5587 INOX	1	PZ																																																																						
VI1220A1	4,2X12 TCB SELF-TAPPIN G SCREW	28	PZ																																																																						
VI1300A0	SCREW M6X12 T1/2T+INOX	12	PZ																																																																						
VI1310A0	ZINC THREAD INSERT M6 FTR/E	8	PZ																																																																						
VI1340A0	M6 ST. STEEL THREADED INSERT	4	PZ																																																																						
VI1810A0	M6X6 STAINLESS STEEL FLATHEAD SCREW	6	PZ																																																																						
VM1182B1	E.S. CT BT HANDLE JUNCTION + PIN GUIDE	1	PZ																																																																						



COMPONENT			SPARE PART																																																																										
Code	Description	Image	Code	Description	Components list																																																																								
VM1978A	CL BL DOOR LOWER FULCRUM-CAP		KDR1254A	XB893 XV893 COMPLETE DOOR	<table border="1"> <thead> <tr> <th>Code</th> <th>Description</th> <th>Qty</th> <th>UOM</th> </tr> </thead> <tbody> <tr> <td>VM1183B0</td> <td>CHEFTOP/BAK ERTOP HANDLE PIN</td> <td>1</td> <td>PZ</td> </tr> <tr> <td>VM1183B1</td> <td>CT BT HANDLE PIN</td> <td>1</td> <td>PZ</td> </tr> <tr> <td>VM1183C0</td> <td>CT BT HANDLE T-SHAPED PIN KIT</td> <td>1</td> <td>PZ</td> </tr> <tr> <td>VM1183C1</td> <td>CT BT HANDLE T-SHAPED PIN KIT</td> <td>1</td> <td>PZ</td> </tr> <tr> <td>VM1490A0</td> <td>CHEFTOP/BAK ERTOP HANDLE SCREWS COVER</td> <td>2</td> <td>PZ</td> </tr> <tr> <td>VM1510A0</td> <td>XBC/XVC GROOVED DOOR PIN BUSHING</td> <td>1</td> <td>PZ</td> </tr> <tr> <td>VM1511A0</td> <td>XBC/XVC SLEEK DOOR PIN BUSHING</td> <td>1</td> <td>PZ</td> </tr> <tr> <td>VM1591A0</td> <td>GLASS BRACKET INT. XVC1004</td> <td>1</td> <td>PZ</td> </tr> <tr> <td>VM1630A0</td> <td>INTERNAL GLASS PUSHING CAP</td> <td>2</td> <td>PZ</td> </tr> <tr> <td>VM1630A1</td> <td>INTERNAL GLASS PUSHING CAP</td> <td>2</td> <td>PZ</td> </tr> <tr> <td>VM1680A0</td> <td>INTERNAL GLASS HINGE</td> <td>2</td> <td>PZ</td> </tr> <tr> <td>VM1695A0</td> <td>HANDLE POSITION PIN</td> <td>4</td> <td>PZ</td> </tr> <tr> <td>VM1976A0</td> <td>CL BL DOOR COLUMN BLANKING CA</td> <td>2</td> <td>PZ</td> </tr> <tr> <td>VM1977A0</td> <td>CL BL DOOR UPPER FULCRUM-CA</td> <td>1</td> <td>PZ</td> </tr> <tr> <td>VM1978A0</td> <td>CL BL DOOR LOWER FULCRUM-CA</td> <td>1</td> <td>PZ</td> </tr> <tr> <td>VM2000A0</td> <td>M4 SOCKET HEAD SCREW COVER</td> <td>6</td> <td>PZ</td> </tr> <tr> <td>VM2008A0</td> <td>SPACER FOR MICROSWITC</td> <td>1</td> <td>PZ</td> </tr> </tbody> </table>	Code	Description	Qty	UOM	VM1183B0	CHEFTOP/BAK ERTOP HANDLE PIN	1	PZ	VM1183B1	CT BT HANDLE PIN	1	PZ	VM1183C0	CT BT HANDLE T-SHAPED PIN KIT	1	PZ	VM1183C1	CT BT HANDLE T-SHAPED PIN KIT	1	PZ	VM1490A0	CHEFTOP/BAK ERTOP HANDLE SCREWS COVER	2	PZ	VM1510A0	XBC/XVC GROOVED DOOR PIN BUSHING	1	PZ	VM1511A0	XBC/XVC SLEEK DOOR PIN BUSHING	1	PZ	VM1591A0	GLASS BRACKET INT. XVC1004	1	PZ	VM1630A0	INTERNAL GLASS PUSHING CAP	2	PZ	VM1630A1	INTERNAL GLASS PUSHING CAP	2	PZ	VM1680A0	INTERNAL GLASS HINGE	2	PZ	VM1695A0	HANDLE POSITION PIN	4	PZ	VM1976A0	CL BL DOOR COLUMN BLANKING CA	2	PZ	VM1977A0	CL BL DOOR UPPER FULCRUM-CA	1	PZ	VM1978A0	CL BL DOOR LOWER FULCRUM-CA	1	PZ	VM2000A0	M4 SOCKET HEAD SCREW COVER	6	PZ	VM2008A0	SPACER FOR MICROSWITC	1	PZ
Code	Description	Qty	UOM																																																																										
VM1183B0	CHEFTOP/BAK ERTOP HANDLE PIN	1	PZ																																																																										
VM1183B1	CT BT HANDLE PIN	1	PZ																																																																										
VM1183C0	CT BT HANDLE T-SHAPED PIN KIT	1	PZ																																																																										
VM1183C1	CT BT HANDLE T-SHAPED PIN KIT	1	PZ																																																																										
VM1490A0	CHEFTOP/BAK ERTOP HANDLE SCREWS COVER	2	PZ																																																																										
VM1510A0	XBC/XVC GROOVED DOOR PIN BUSHING	1	PZ																																																																										
VM1511A0	XBC/XVC SLEEK DOOR PIN BUSHING	1	PZ																																																																										
VM1591A0	GLASS BRACKET INT. XVC1004	1	PZ																																																																										
VM1630A0	INTERNAL GLASS PUSHING CAP	2	PZ																																																																										
VM1630A1	INTERNAL GLASS PUSHING CAP	2	PZ																																																																										
VM1680A0	INTERNAL GLASS HINGE	2	PZ																																																																										
VM1695A0	HANDLE POSITION PIN	4	PZ																																																																										
VM1976A0	CL BL DOOR COLUMN BLANKING CA	2	PZ																																																																										
VM1977A0	CL BL DOOR UPPER FULCRUM-CA	1	PZ																																																																										
VM1978A0	CL BL DOOR LOWER FULCRUM-CA	1	PZ																																																																										
VM2000A0	M4 SOCKET HEAD SCREW COVER	6	PZ																																																																										
VM2008A0	SPACER FOR MICROSWITC	1	PZ																																																																										





COMPONENT			SPARE PART																																										
Code	Description	Image	Code	Description	Components list																																								
VM1978A	CL BL DOOR LOWER FULCRUM-CAP		KDR1254A	XB893 XV893 COMPLETE DOOR	<table border="1"> <thead> <tr> <th>Code</th> <th>Description</th> <th>Qty</th> <th>UOM</th> </tr> </thead> <tbody> <tr> <td>VM2042A0</td> <td>INTERNAL GLASS LATERAL LOCKING SYSTEM</td> <td>2</td> <td>PZ</td> </tr> <tr> <td>VM2043A0</td> <td>UPPER - LOWER GLASS SUPPORT</td> <td>2</td> <td>PZ</td> </tr> <tr> <td>VM2245A0</td> <td>HANDLE SHAFT WITH LATCH</td> <td>1</td> <td>PZ</td> </tr> <tr> <td>VM2247A0</td> <td>HANDLE SHAFT COVER VM2245-2246</td> <td>1</td> <td>PZ</td> </tr> <tr> <td>VM2247B0</td> <td>HANDLE SHAFT COVER VM2245-2246</td> <td>1</td> <td>PZ</td> </tr> <tr> <td>VT1140A0</td> <td>XB893/895 XBC804/805 INTERNAL GLASS</td> <td>1</td> <td>PZ</td> </tr> <tr> <td>VT1140A0</td> <td>XB893/895 XBC804/805 INTERNAL GLASS</td> <td>1</td> <td>PZ</td> </tr> <tr> <td>VT1254A0</td> <td>OUTER GLASS XB89- XC89-</td> <td>1</td> <td>PZ</td> </tr> <tr> <td>VT1254A0</td> <td>OUTER GLASS XB89- XC89-</td> <td>1</td> <td>PZ</td> </tr> </tbody> </table>	Code	Description	Qty	UOM	VM2042A0	INTERNAL GLASS LATERAL LOCKING SYSTEM	2	PZ	VM2043A0	UPPER - LOWER GLASS SUPPORT	2	PZ	VM2245A0	HANDLE SHAFT WITH LATCH	1	PZ	VM2247A0	HANDLE SHAFT COVER VM2245-2246	1	PZ	VM2247B0	HANDLE SHAFT COVER VM2245-2246	1	PZ	VT1140A0	XB893/895 XBC804/805 INTERNAL GLASS	1	PZ	VT1140A0	XB893/895 XBC804/805 INTERNAL GLASS	1	PZ	VT1254A0	OUTER GLASS XB89- XC89-	1	PZ	VT1254A0	OUTER GLASS XB89- XC89-	1	PZ
Code	Description	Qty	UOM																																										
VM2042A0	INTERNAL GLASS LATERAL LOCKING SYSTEM	2	PZ																																										
VM2043A0	UPPER - LOWER GLASS SUPPORT	2	PZ																																										
VM2245A0	HANDLE SHAFT WITH LATCH	1	PZ																																										
VM2247A0	HANDLE SHAFT COVER VM2245-2246	1	PZ																																										
VM2247B0	HANDLE SHAFT COVER VM2245-2246	1	PZ																																										
VT1140A0	XB893/895 XBC804/805 INTERNAL GLASS	1	PZ																																										
VT1140A0	XB893/895 XBC804/805 INTERNAL GLASS	1	PZ																																										
VT1254A0	OUTER GLASS XB89- XC89-	1	PZ																																										
VT1254A0	OUTER GLASS XB89- XC89-	1	PZ																																										
VM1976A	CL BL DOOR COLUMN BLANKING CAP		KVM1976A	CL BL DOOR COLUMN BLANKING CAP KIT	<table border="1"> <thead> <tr> <th>Code</th> <th>Description</th> <th>Qty</th> <th>UOM</th> </tr> </thead> <tbody> <tr> <td>VM1224A0</td> <td>65MY 220MM 2 COLOURS SHRINK TUBE</td> <td>0.200</td> <td>M</td> </tr> <tr> <td>VM1976A0</td> <td>CL BL DOOR COLUMN BLANKING CA</td> <td>1</td> <td>PZ</td> </tr> </tbody> </table>	Code	Description	Qty	UOM	VM1224A0	65MY 220MM 2 COLOURS SHRINK TUBE	0.200	M	VM1976A0	CL BL DOOR COLUMN BLANKING CA	1	PZ																												
Code	Description	Qty	UOM																																										
VM1224A0	65MY 220MM 2 COLOURS SHRINK TUBE	0.200	M																																										
VM1976A0	CL BL DOOR COLUMN BLANKING CA	1	PZ																																										
VM1680A	INTERNAL GLASS HINGE		KVM1680A	INTERNAL GLASS HINGE SUPPORT 2 PCS KIT	<table border="1"> <thead> <tr> <th>Code</th> <th>Description</th> <th>Qty</th> <th>UOM</th> </tr> </thead> <tbody> <tr> <td>VM1224A0</td> <td>65MY 220MM 2 COLOURS SHRINK TUBE</td> <td>0.200</td> <td>M</td> </tr> <tr> <td>VM1680A0</td> <td>INTERNAL GLASS HINGE</td> <td>2</td> <td>PZ</td> </tr> </tbody> </table>	Code	Description	Qty	UOM	VM1224A0	65MY 220MM 2 COLOURS SHRINK TUBE	0.200	M	VM1680A0	INTERNAL GLASS HINGE	2	PZ																												
Code	Description	Qty	UOM																																										
VM1224A0	65MY 220MM 2 COLOURS SHRINK TUBE	0.200	M																																										
VM1680A0	INTERNAL GLASS HINGE	2	PZ																																										



COMPONENT			SPARE PART																																										
Code	Description	Image	Code	Description	Components list																																								
VM2043A	UPPER - LOWER GLASS SUPPORT		KVM2043A	UPPER - LOWER GLASS SUPPORT 2 PCS KIT	<table border="1"> <thead> <tr> <th>Code</th> <th>Description</th> <th>Qty</th> <th>UOM</th> </tr> </thead> <tbody> <tr> <td>VM1224A0</td> <td>65MY 220MM 2 COLOURS SHRINK TUBE</td> <td>0.150</td> <td>M</td> </tr> <tr> <td>VM2043A0</td> <td>UPPER - LOWER GLASS SUPPORT</td> <td>2</td> <td>PZ</td> </tr> </tbody> </table>	Code	Description	Qty	UOM	VM1224A0	65MY 220MM 2 COLOURS SHRINK TUBE	0.150	M	VM2043A0	UPPER - LOWER GLASS SUPPORT	2	PZ																												
Code	Description	Qty	UOM																																										
VM1224A0	65MY 220MM 2 COLOURS SHRINK TUBE	0.150	M																																										
VM2043A0	UPPER - LOWER GLASS SUPPORT	2	PZ																																										
VM2042A	INTERNAL GLASS LATERAL LOCKING SYSTEM		KVM2042A	INTERNAL GLASS SPRING STOPPER KIT	<table border="1"> <thead> <tr> <th>Code</th> <th>Description</th> <th>Qty</th> <th>UOM</th> </tr> </thead> <tbody> <tr> <td>RC1200A0</td> <td>ED=4 WIRE D.=0.5 COMPRESSION SPRING</td> <td>2</td> <td>PZ</td> </tr> <tr> <td>VI1220A1</td> <td>4.2X12 TCB SELF-TAPPING SCREW</td> <td>2</td> <td>PZ</td> </tr> <tr> <td>VM1224A0</td> <td>65MY 220MM 2 COLOURS SHRINK TUBE</td> <td>0.200</td> <td>M</td> </tr> <tr> <td>VM2042A0</td> <td>INTERNAL GLASS LATERAL LOCKING SYSTEM</td> <td>1</td> <td>PZ</td> </tr> </tbody> </table>	Code	Description	Qty	UOM	RC1200A0	ED=4 WIRE D.=0.5 COMPRESSION SPRING	2	PZ	VI1220A1	4.2X12 TCB SELF-TAPPING SCREW	2	PZ	VM1224A0	65MY 220MM 2 COLOURS SHRINK TUBE	0.200	M	VM2042A0	INTERNAL GLASS LATERAL LOCKING SYSTEM	1	PZ																				
Code	Description	Qty	UOM																																										
RC1200A0	ED=4 WIRE D.=0.5 COMPRESSION SPRING	2	PZ																																										
VI1220A1	4.2X12 TCB SELF-TAPPING SCREW	2	PZ																																										
VM1224A0	65MY 220MM 2 COLOURS SHRINK TUBE	0.200	M																																										
VM2042A0	INTERNAL GLASS LATERAL LOCKING SYSTEM	1	PZ																																										
VM1620A	LED BAR LOWER SUPPORT		KLP1044A	LUX LED BAR KIT	<table border="1"> <thead> <tr> <th>Code</th> <th>Description</th> <th>Qty</th> <th>UOM</th> </tr> </thead> <tbody> <tr> <td>CE1455A0</td> <td>TIP END FITTING</td> <td>2</td> <td>PZ</td> </tr> <tr> <td>CE1730A0</td> <td>PVC CABLE NP 2 X AWG22 STYLE 2095</td> <td>4.500</td> <td>M</td> </tr> <tr> <td>CE1735A0</td> <td>MINIFIT FEMALE END FITTING</td> <td>2</td> <td>PZ</td> </tr> <tr> <td>CE1740A0</td> <td>MINIFIT MALE END FITTING</td> <td>4</td> <td>PZ</td> </tr> <tr> <td>CE1745A0</td> <td>2 WAYS FEMALE MINIFIT CONNECTOR</td> <td>2</td> <td>PZ</td> </tr> <tr> <td>CE1750A0</td> <td>3 WAYS MALE MINIFIT CONNECTOR</td> <td>1</td> <td>PZ</td> </tr> <tr> <td>LP1044A0</td> <td>LUX LED BAR</td> <td>1</td> <td>PZ</td> </tr> <tr> <td>VM1620A0</td> <td>LED BAR LOWER SUPPORT</td> <td>1</td> <td>PZ</td> </tr> <tr> <td>VM1621A0</td> <td>LED BAR UPPER SUPPORT</td> <td>1</td> <td>PZ</td> </tr> </tbody> </table>	Code	Description	Qty	UOM	CE1455A0	TIP END FITTING	2	PZ	CE1730A0	PVC CABLE NP 2 X AWG22 STYLE 2095	4.500	M	CE1735A0	MINIFIT FEMALE END FITTING	2	PZ	CE1740A0	MINIFIT MALE END FITTING	4	PZ	CE1745A0	2 WAYS FEMALE MINIFIT CONNECTOR	2	PZ	CE1750A0	3 WAYS MALE MINIFIT CONNECTOR	1	PZ	LP1044A0	LUX LED BAR	1	PZ	VM1620A0	LED BAR LOWER SUPPORT	1	PZ	VM1621A0	LED BAR UPPER SUPPORT	1	PZ
Code	Description	Qty	UOM																																										
CE1455A0	TIP END FITTING	2	PZ																																										
CE1730A0	PVC CABLE NP 2 X AWG22 STYLE 2095	4.500	M																																										
CE1735A0	MINIFIT FEMALE END FITTING	2	PZ																																										
CE1740A0	MINIFIT MALE END FITTING	4	PZ																																										
CE1745A0	2 WAYS FEMALE MINIFIT CONNECTOR	2	PZ																																										
CE1750A0	3 WAYS MALE MINIFIT CONNECTOR	1	PZ																																										
LP1044A0	LUX LED BAR	1	PZ																																										
VM1620A0	LED BAR LOWER SUPPORT	1	PZ																																										
VM1621A0	LED BAR UPPER SUPPORT	1	PZ																																										
			KLP1007A	L200 LED BAR KIT	<table border="1"> <thead> <tr> <th>Code</th> <th>Description</th> <th>Qty</th> <th>UOM</th> </tr> </thead> <tbody> <tr> <td>CE1455A0</td> <td>TIP END FITTING</td> <td>2</td> <td>PZ</td> </tr> </tbody> </table>	Code	Description	Qty	UOM	CE1455A0	TIP END FITTING	2	PZ																																
Code	Description	Qty	UOM																																										
CE1455A0	TIP END FITTING	2	PZ																																										



COMPONENT			SPARE PART																																											
Code	Description	Image	Code	Description	Components list																																									
VM1620A	LED BAR LOWER SUPPORT		KLP1007A	L200 LED BAR KIT	<table border="1"> <thead> <tr> <th>Code</th> <th>Description</th> <th>Qty</th> <th>UOM</th> </tr> </thead> <tbody> <tr> <td>CE1730A0</td> <td>PVC CABLE NP 2 X AWG22 STYLE 2095</td> <td>4.500</td> <td>M</td> </tr> <tr> <td>CE1735A0</td> <td>MINIFIT FEMALE END FITTING</td> <td>2</td> <td>PZ</td> </tr> <tr> <td>CE1740A0</td> <td>MINIFIT MALE END FITTING</td> <td>4</td> <td>PZ</td> </tr> <tr> <td>CE1745A0</td> <td>2 WAYS FEMALE MINIFIT CONNECTOR</td> <td>2</td> <td>PZ</td> </tr> <tr> <td>CE1750A0</td> <td>3 WAYS MALE MINIFIT CONNECTOR</td> <td>1</td> <td>PZ</td> </tr> <tr> <td>LP1007A0</td> <td>LED LIGHT BAR L200</td> <td>1</td> <td>PZ</td> </tr> <tr> <td>VM1620A0</td> <td>LED BAR LOWER SUPPORT</td> <td>1</td> <td>PZ</td> </tr> <tr> <td>VM1621A0</td> <td>LED BAR UPPER SUPPORT</td> <td>1</td> <td>PZ</td> </tr> </tbody> </table>	Code	Description	Qty	UOM	CE1730A0	PVC CABLE NP 2 X AWG22 STYLE 2095	4.500	M	CE1735A0	MINIFIT FEMALE END FITTING	2	PZ	CE1740A0	MINIFIT MALE END FITTING	4	PZ	CE1745A0	2 WAYS FEMALE MINIFIT CONNECTOR	2	PZ	CE1750A0	3 WAYS MALE MINIFIT CONNECTOR	1	PZ	LP1007A0	LED LIGHT BAR L200	1	PZ	VM1620A0	LED BAR LOWER SUPPORT	1	PZ	VM1621A0	LED BAR UPPER SUPPORT	1	PZ					
			Code	Description	Qty	UOM																																								
CE1730A0	PVC CABLE NP 2 X AWG22 STYLE 2095	4.500	M																																											
CE1735A0	MINIFIT FEMALE END FITTING	2	PZ																																											
CE1740A0	MINIFIT MALE END FITTING	4	PZ																																											
CE1745A0	2 WAYS FEMALE MINIFIT CONNECTOR	2	PZ																																											
CE1750A0	3 WAYS MALE MINIFIT CONNECTOR	1	PZ																																											
LP1007A0	LED LIGHT BAR L200	1	PZ																																											
VM1620A0	LED BAR LOWER SUPPORT	1	PZ																																											
VM1621A0	LED BAR UPPER SUPPORT	1	PZ																																											
KLP1004B	L1000 LED BAR KIT	<table border="1"> <thead> <tr> <th>Code</th> <th>Description</th> <th>Qty</th> <th>UOM</th> </tr> </thead> <tbody> <tr> <td>CE1730A0</td> <td>PVC CABLE NP 2 X AWG22 STYLE 2095</td> <td>1</td> <td>M</td> </tr> <tr> <td>CE1735A0</td> <td>MINIFIT FEMALE END FITTING</td> <td>2</td> <td>PZ</td> </tr> <tr> <td>CE1740A0</td> <td>MINIFIT MALE END FITTING</td> <td>2</td> <td>PZ</td> </tr> <tr> <td>CE1745A0</td> <td>2 WAYS FEMALE MINIFIT CONNECTOR</td> <td>1</td> <td>PZ</td> </tr> <tr> <td>CE1750A0</td> <td>3 WAYS MALE MINIFIT CONNECTOR</td> <td>1</td> <td>PZ</td> </tr> <tr> <td>IP1385A1</td> <td>CORNER POLYSTYREN E PACKING 110X80X2000</td> <td>2.200</td> <td>M</td> </tr> <tr> <td>LP1004B0</td> <td>LEB LIGHTING BAR L1000</td> <td>1</td> <td>PZ</td> </tr> <tr> <td>VM1059A1</td> <td>HEAT SHRINK FILM H800</td> <td>1.300</td> <td>M</td> </tr> <tr> <td>VM1620A0</td> <td>LED BAR LOWER SUPPORT</td> <td>1</td> <td>PZ</td> </tr> <tr> <td>VM1621A0</td> <td>LED BAR UPPER SUPPORT</td> <td>1</td> <td>PZ</td> </tr> </tbody> </table>	Code	Description	Qty	UOM	CE1730A0	PVC CABLE NP 2 X AWG22 STYLE 2095	1	M	CE1735A0	MINIFIT FEMALE END FITTING	2	PZ	CE1740A0	MINIFIT MALE END FITTING	2	PZ	CE1745A0	2 WAYS FEMALE MINIFIT CONNECTOR	1	PZ	CE1750A0	3 WAYS MALE MINIFIT CONNECTOR	1	PZ	IP1385A1	CORNER POLYSTYREN E PACKING 110X80X2000	2.200	M	LP1004B0	LEB LIGHTING BAR L1000	1	PZ	VM1059A1	HEAT SHRINK FILM H800	1.300	M	VM1620A0	LED BAR LOWER SUPPORT	1	PZ	VM1621A0	LED BAR UPPER SUPPORT	1	PZ
Code	Description	Qty	UOM																																											
CE1730A0	PVC CABLE NP 2 X AWG22 STYLE 2095	1	M																																											
CE1735A0	MINIFIT FEMALE END FITTING	2	PZ																																											
CE1740A0	MINIFIT MALE END FITTING	2	PZ																																											
CE1745A0	2 WAYS FEMALE MINIFIT CONNECTOR	1	PZ																																											
CE1750A0	3 WAYS MALE MINIFIT CONNECTOR	1	PZ																																											
IP1385A1	CORNER POLYSTYREN E PACKING 110X80X2000	2.200	M																																											
LP1004B0	LEB LIGHTING BAR L1000	1	PZ																																											
VM1059A1	HEAT SHRINK FILM H800	1.300	M																																											
VM1620A0	LED BAR LOWER SUPPORT	1	PZ																																											
VM1621A0	LED BAR UPPER SUPPORT	1	PZ																																											

COMPONENT			SPARE PART																																														
Code	Description	Image	Code	Description	Components list																																												
VM1620A	LED BAR LOWER SUPPORT		KLP1003B	2017 LED BAR KIT	<table border="1"> <thead> <tr> <th>Code</th> <th>Description</th> <th>Qty</th> <th>UOM</th> </tr> </thead> <tbody> <tr> <td>CE1730A0</td> <td>PVC CABLE NP 2 X AWG22 STYLE 2095</td> <td>1</td> <td>M</td> </tr> <tr> <td>CE1735A0</td> <td>MINIFIT FEMALE END FITTING</td> <td>2</td> <td>PZ</td> </tr> <tr> <td>CE1740A0</td> <td>MINIFIT MALE END FITTING</td> <td>2</td> <td>PZ</td> </tr> <tr> <td>CE1745A0</td> <td>2 WAYS FEMALE MINIFIT CONNECTOR</td> <td>1</td> <td>PZ</td> </tr> <tr> <td>CE1750A0</td> <td>3 WAYS MALE MINIFIT CONNECTOR</td> <td>1</td> <td>PZ</td> </tr> <tr> <td>LP1003B0</td> <td>LED LIGHT BAR L600</td> <td>1</td> <td>PZ</td> </tr> <tr> <td>VM1620A0</td> <td>LED BAR LOWER SUPPORT</td> <td>1</td> <td>PZ</td> </tr> <tr> <td>VM1621A0</td> <td>LED BAR UPPER SUPPORT</td> <td>1</td> <td>PZ</td> </tr> <tr> <td>VM1794A0</td> <td>250X4.8 PA66 BLACK CLAMP</td> <td>2</td> <td>PZ</td> </tr> <tr> <td>VM2103A0</td> <td>CLAMP LOCK</td> <td>2</td> <td>PZ</td> </tr> </tbody> </table>	Code	Description	Qty	UOM	CE1730A0	PVC CABLE NP 2 X AWG22 STYLE 2095	1	M	CE1735A0	MINIFIT FEMALE END FITTING	2	PZ	CE1740A0	MINIFIT MALE END FITTING	2	PZ	CE1745A0	2 WAYS FEMALE MINIFIT CONNECTOR	1	PZ	CE1750A0	3 WAYS MALE MINIFIT CONNECTOR	1	PZ	LP1003B0	LED LIGHT BAR L600	1	PZ	VM1620A0	LED BAR LOWER SUPPORT	1	PZ	VM1621A0	LED BAR UPPER SUPPORT	1	PZ	VM1794A0	250X4.8 PA66 BLACK CLAMP	2	PZ	VM2103A0	CLAMP LOCK	2	PZ
			Code	Description	Qty	UOM																																											
CE1730A0	PVC CABLE NP 2 X AWG22 STYLE 2095	1	M																																														
CE1735A0	MINIFIT FEMALE END FITTING	2	PZ																																														
CE1740A0	MINIFIT MALE END FITTING	2	PZ																																														
CE1745A0	2 WAYS FEMALE MINIFIT CONNECTOR	1	PZ																																														
CE1750A0	3 WAYS MALE MINIFIT CONNECTOR	1	PZ																																														
LP1003B0	LED LIGHT BAR L600	1	PZ																																														
VM1620A0	LED BAR LOWER SUPPORT	1	PZ																																														
VM1621A0	LED BAR UPPER SUPPORT	1	PZ																																														
VM1794A0	250X4.8 PA66 BLACK CLAMP	2	PZ																																														
VM2103A0	CLAMP LOCK	2	PZ																																														
KLP1002B	L400 LED BAR KIT	<table border="1"> <thead> <tr> <th>Code</th> <th>Description</th> <th>Qty</th> <th>UOM</th> </tr> </thead> <tbody> <tr> <td>CE1455A0</td> <td>TIP END FITTING</td> <td>2</td> <td>PZ</td> </tr> <tr> <td>CE1730A0</td> <td>PVC CABLE NP 2 X AWG22 STYLE 2095</td> <td>4.500</td> <td>M</td> </tr> <tr> <td>CE1735A0</td> <td>MINIFIT FEMALE END FITTING</td> <td>2</td> <td>PZ</td> </tr> <tr> <td>CE1740A0</td> <td>MINIFIT MALE END FITTING</td> <td>4</td> <td>PZ</td> </tr> <tr> <td>CE1745A0</td> <td>2 WAYS FEMALE MINIFIT CONNECTOR</td> <td>2</td> <td>PZ</td> </tr> <tr> <td>CE1750A0</td> <td>3 WAYS MALE MINIFIT CONNECTOR</td> <td>1</td> <td>PZ</td> </tr> <tr> <td>LP1002B0</td> <td>LED LIGHTING BAR L400</td> <td>1</td> <td>PZ</td> </tr> <tr> <td>VM1620A0</td> <td>LED BAR LOWER SUPPORT</td> <td>1</td> <td>PZ</td> </tr> <tr> <td>VM1621A0</td> <td>LED BAR UPPER SUPPORT</td> <td>1</td> <td>PZ</td> </tr> </tbody> </table>	Code	Description	Qty	UOM	CE1455A0	TIP END FITTING	2	PZ	CE1730A0	PVC CABLE NP 2 X AWG22 STYLE 2095	4.500	M	CE1735A0	MINIFIT FEMALE END FITTING	2	PZ	CE1740A0	MINIFIT MALE END FITTING	4	PZ	CE1745A0	2 WAYS FEMALE MINIFIT CONNECTOR	2	PZ	CE1750A0	3 WAYS MALE MINIFIT CONNECTOR	1	PZ	LP1002B0	LED LIGHTING BAR L400	1	PZ	VM1620A0	LED BAR LOWER SUPPORT	1	PZ	VM1621A0	LED BAR UPPER SUPPORT	1	PZ							
Code	Description	Qty	UOM																																														
CE1455A0	TIP END FITTING	2	PZ																																														
CE1730A0	PVC CABLE NP 2 X AWG22 STYLE 2095	4.500	M																																														
CE1735A0	MINIFIT FEMALE END FITTING	2	PZ																																														
CE1740A0	MINIFIT MALE END FITTING	4	PZ																																														
CE1745A0	2 WAYS FEMALE MINIFIT CONNECTOR	2	PZ																																														
CE1750A0	3 WAYS MALE MINIFIT CONNECTOR	1	PZ																																														
LP1002B0	LED LIGHTING BAR L400	1	PZ																																														
VM1620A0	LED BAR LOWER SUPPORT	1	PZ																																														
VM1621A0	LED BAR UPPER SUPPORT	1	PZ																																														

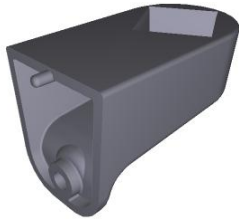

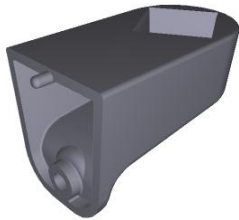
COMPONENT			SPARE PART																																																													
Code	Description	Image	Code	Description	Components list																																																											
VM1620A	LED BAR LOWER SUPPORT		KLP1001B	L300 LED BAR KIT	<table border="1"> <thead> <tr> <th>Code</th> <th>Description</th> <th>Qty</th> <th>UOM</th> </tr> </thead> <tbody> <tr> <td>CE1455A0</td> <td>TIP END FITTING</td> <td>2</td> <td>PZ</td> </tr> <tr> <td>CE1730A0</td> <td>PVC CABLE NP 2 X AWG22 STYLE 2095</td> <td>4.500</td> <td>M</td> </tr> <tr> <td>CE1735A0</td> <td>MINIFIT FEMALE END FITTING</td> <td>2</td> <td>PZ</td> </tr> <tr> <td>CE1740A0</td> <td>MINIFIT MALE END FITTING</td> <td>4</td> <td>PZ</td> </tr> <tr> <td>CE1745A0</td> <td>2 WAYS FEMALE MINIFIT CONNECTOR</td> <td>2</td> <td>PZ</td> </tr> <tr> <td>CE1750A0</td> <td>3 WAYS MALE MINIFIT CONNECTOR</td> <td>1</td> <td>PZ</td> </tr> <tr> <td>LP1001B0</td> <td>LED LIGHTING BAR L300</td> <td>1</td> <td>PZ</td> </tr> <tr> <td>VM1620A0</td> <td>LED BAR LOWER SUPPORT</td> <td>1</td> <td>PZ</td> </tr> <tr> <td>VM1621A0</td> <td>LED BAR UPPER SUPPORT</td> <td>1</td> <td>PZ</td> </tr> </tbody> </table>	Code	Description	Qty	UOM	CE1455A0	TIP END FITTING	2	PZ	CE1730A0	PVC CABLE NP 2 X AWG22 STYLE 2095	4.500	M	CE1735A0	MINIFIT FEMALE END FITTING	2	PZ	CE1740A0	MINIFIT MALE END FITTING	4	PZ	CE1745A0	2 WAYS FEMALE MINIFIT CONNECTOR	2	PZ	CE1750A0	3 WAYS MALE MINIFIT CONNECTOR	1	PZ	LP1001B0	LED LIGHTING BAR L300	1	PZ	VM1620A0	LED BAR LOWER SUPPORT	1	PZ	VM1621A0	LED BAR UPPER SUPPORT	1	PZ	KLP1000A	L100 LED BAR KIT	<table border="1"> <thead> <tr> <th>Code</th> <th>Description</th> <th>Qty</th> <th>UOM</th> </tr> </thead> <tbody> <tr> <td>LP1000A0</td> <td>LED LIGHTING BAR L100</td> <td>1</td> <td>PZ</td> </tr> <tr> <td>VM1620A0</td> <td>LED BAR LOWER SUPPORT</td> <td>1</td> <td>PZ</td> </tr> <tr> <td>VM1621A0</td> <td>LED BAR UPPER SUPPORT</td> <td>1</td> <td>PZ</td> </tr> </tbody> </table>	Code	Description	Qty	UOM	LP1000A0	LED LIGHTING BAR L100	1	PZ	VM1620A0	LED BAR LOWER SUPPORT	1	PZ	VM1621A0	LED BAR UPPER SUPPORT	1	PZ
			Code	Description	Qty	UOM																																																										
CE1455A0	TIP END FITTING	2	PZ																																																													
CE1730A0	PVC CABLE NP 2 X AWG22 STYLE 2095	4.500	M																																																													
CE1735A0	MINIFIT FEMALE END FITTING	2	PZ																																																													
CE1740A0	MINIFIT MALE END FITTING	4	PZ																																																													
CE1745A0	2 WAYS FEMALE MINIFIT CONNECTOR	2	PZ																																																													
CE1750A0	3 WAYS MALE MINIFIT CONNECTOR	1	PZ																																																													
LP1001B0	LED LIGHTING BAR L300	1	PZ																																																													
VM1620A0	LED BAR LOWER SUPPORT	1	PZ																																																													
VM1621A0	LED BAR UPPER SUPPORT	1	PZ																																																													
Code	Description	Qty	UOM																																																													
LP1000A0	LED LIGHTING BAR L100	1	PZ																																																													
VM1620A0	LED BAR LOWER SUPPORT	1	PZ																																																													
VM1621A0	LED BAR UPPER SUPPORT	1	PZ																																																													
VM1621A	LED BAR UPPER SUPPORT		KLP1044A	LUX LED BAR KIT	<table border="1"> <thead> <tr> <th>Code</th> <th>Description</th> <th>Qty</th> <th>UOM</th> </tr> </thead> <tbody> <tr> <td>CE1455A0</td> <td>TIP END FITTING</td> <td>2</td> <td>PZ</td> </tr> <tr> <td>CE1730A0</td> <td>PVC CABLE NP 2 X AWG22 STYLE 2095</td> <td>4.500</td> <td>M</td> </tr> <tr> <td>CE1735A0</td> <td>MINIFIT FEMALE END FITTING</td> <td>2</td> <td>PZ</td> </tr> <tr> <td>CE1740A0</td> <td>MINIFIT MALE END FITTING</td> <td>4</td> <td>PZ</td> </tr> <tr> <td>CE1745A0</td> <td>2 WAYS FEMALE MINIFIT CONNECTOR</td> <td>2</td> <td>PZ</td> </tr> <tr> <td>CE1750A0</td> <td>3 WAYS MALE MINIFIT CONNECTOR</td> <td>1</td> <td>PZ</td> </tr> <tr> <td>LP1044A0</td> <td>LUX LED BAR</td> <td>1</td> <td>PZ</td> </tr> </tbody> </table>	Code	Description	Qty	UOM	CE1455A0	TIP END FITTING	2	PZ	CE1730A0	PVC CABLE NP 2 X AWG22 STYLE 2095	4.500	M	CE1735A0	MINIFIT FEMALE END FITTING	2	PZ	CE1740A0	MINIFIT MALE END FITTING	4	PZ	CE1745A0	2 WAYS FEMALE MINIFIT CONNECTOR	2	PZ	CE1750A0	3 WAYS MALE MINIFIT CONNECTOR	1	PZ	LP1044A0	LUX LED BAR	1	PZ																											
Code	Description	Qty	UOM																																																													
CE1455A0	TIP END FITTING	2	PZ																																																													
CE1730A0	PVC CABLE NP 2 X AWG22 STYLE 2095	4.500	M																																																													
CE1735A0	MINIFIT FEMALE END FITTING	2	PZ																																																													
CE1740A0	MINIFIT MALE END FITTING	4	PZ																																																													
CE1745A0	2 WAYS FEMALE MINIFIT CONNECTOR	2	PZ																																																													
CE1750A0	3 WAYS MALE MINIFIT CONNECTOR	1	PZ																																																													
LP1044A0	LUX LED BAR	1	PZ																																																													

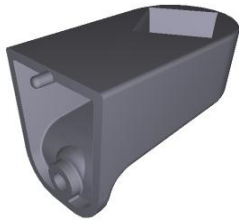
COMPONENT			SPARE PART																																							
Code	Description	Image	Code	Description	Components list																																					
VM1621A	LED BAR UPPER SUPPORT		KLP1044A	LUX LED BAR KIT	<table border="1"> <thead> <tr> <th>Code</th> <th>Description</th> <th>Qty</th> <th>UOM</th> </tr> </thead> <tbody> <tr> <td>VM1620A0</td> <td>LED BAR LOWER SUPPORT</td> <td>1</td> <td>PZ</td> </tr> <tr> <td>VM1621A0</td> <td>LED BAR UPPER SUPPORT</td> <td>1</td> <td>PZ</td> </tr> </tbody> </table>	Code	Description	Qty	UOM	VM1620A0	LED BAR LOWER SUPPORT	1	PZ	VM1621A0	LED BAR UPPER SUPPORT	1	PZ																									
			Code	Description	Qty	UOM																																				
			VM1620A0	LED BAR LOWER SUPPORT	1	PZ																																				
VM1621A0	LED BAR UPPER SUPPORT	1	PZ																																							
KLP1007A	L200 LED BAR KIT	<table border="1"> <thead> <tr> <th>Code</th> <th>Description</th> <th>Qty</th> <th>UOM</th> </tr> </thead> <tbody> <tr> <td>CE1455A0</td> <td>TIP END FITTING</td> <td>2</td> <td>PZ</td> </tr> <tr> <td>CE1730A0</td> <td>PVC CABLE NP 2 X AWG22 STYLE 2095</td> <td>4.500</td> <td>M</td> </tr> <tr> <td>CE1735A0</td> <td>MINIFIT FEMALE END FITTING</td> <td>2</td> <td>PZ</td> </tr> <tr> <td>CE1740A0</td> <td>MINIFIT MALE END FITTING</td> <td>4</td> <td>PZ</td> </tr> <tr> <td>CE1745A0</td> <td>2 WAYS FEMALE MINIFIT CONNECTOR</td> <td>2</td> <td>PZ</td> </tr> <tr> <td>CE1750A0</td> <td>3 WAYS MALE MINIFIT CONNECTOR</td> <td>1</td> <td>PZ</td> </tr> <tr> <td>LP1007A0</td> <td>LED LIGHT BAR L200</td> <td>1</td> <td>PZ</td> </tr> <tr> <td>VM1620A0</td> <td>LED BAR LOWER SUPPORT</td> <td>1</td> <td>PZ</td> </tr> <tr> <td>VM1621A0</td> <td>LED BAR UPPER SUPPORT</td> <td>1</td> <td>PZ</td> </tr> </tbody> </table>	Code	Description	Qty	UOM	CE1455A0	TIP END FITTING	2	PZ	CE1730A0	PVC CABLE NP 2 X AWG22 STYLE 2095	4.500	M	CE1735A0	MINIFIT FEMALE END FITTING	2	PZ	CE1740A0	MINIFIT MALE END FITTING	4	PZ	CE1745A0	2 WAYS FEMALE MINIFIT CONNECTOR	2	PZ	CE1750A0	3 WAYS MALE MINIFIT CONNECTOR	1	PZ	LP1007A0	LED LIGHT BAR L200	1	PZ	VM1620A0	LED BAR LOWER SUPPORT	1	PZ	VM1621A0	LED BAR UPPER SUPPORT	1	PZ
Code	Description	Qty	UOM																																							
CE1455A0	TIP END FITTING	2	PZ																																							
CE1730A0	PVC CABLE NP 2 X AWG22 STYLE 2095	4.500	M																																							
CE1735A0	MINIFIT FEMALE END FITTING	2	PZ																																							
CE1740A0	MINIFIT MALE END FITTING	4	PZ																																							
CE1745A0	2 WAYS FEMALE MINIFIT CONNECTOR	2	PZ																																							
CE1750A0	3 WAYS MALE MINIFIT CONNECTOR	1	PZ																																							
LP1007A0	LED LIGHT BAR L200	1	PZ																																							
VM1620A0	LED BAR LOWER SUPPORT	1	PZ																																							
VM1621A0	LED BAR UPPER SUPPORT	1	PZ																																							
KLP1004B	L1000 LED BAR KIT	<table border="1"> <thead> <tr> <th>Code</th> <th>Description</th> <th>Qty</th> <th>UOM</th> </tr> </thead> <tbody> <tr> <td>CE1730A0</td> <td>PVC CABLE NP 2 X AWG22 STYLE 2095</td> <td>1</td> <td>M</td> </tr> <tr> <td>CE1735A0</td> <td>MINIFIT FEMALE END FITTING</td> <td>2</td> <td>PZ</td> </tr> <tr> <td>CE1740A0</td> <td>MINIFIT MALE END FITTING</td> <td>2</td> <td>PZ</td> </tr> <tr> <td>CE1745A0</td> <td>2 WAYS FEMALE MINIFIT CONNECTOR</td> <td>1</td> <td>PZ</td> </tr> <tr> <td>CE1750A0</td> <td>3 WAYS MALE MINIFIT CONNECTOR</td> <td>1</td> <td>PZ</td> </tr> <tr> <td>IP1385A1</td> <td>CORNER POLYSTYREN E PACKING 110X80X2000</td> <td>2.200</td> <td>M</td> </tr> </tbody> </table>	Code	Description	Qty	UOM	CE1730A0	PVC CABLE NP 2 X AWG22 STYLE 2095	1	M	CE1735A0	MINIFIT FEMALE END FITTING	2	PZ	CE1740A0	MINIFIT MALE END FITTING	2	PZ	CE1745A0	2 WAYS FEMALE MINIFIT CONNECTOR	1	PZ	CE1750A0	3 WAYS MALE MINIFIT CONNECTOR	1	PZ	IP1385A1	CORNER POLYSTYREN E PACKING 110X80X2000	2.200	M												
Code	Description	Qty	UOM																																							
CE1730A0	PVC CABLE NP 2 X AWG22 STYLE 2095	1	M																																							
CE1735A0	MINIFIT FEMALE END FITTING	2	PZ																																							
CE1740A0	MINIFIT MALE END FITTING	2	PZ																																							
CE1745A0	2 WAYS FEMALE MINIFIT CONNECTOR	1	PZ																																							
CE1750A0	3 WAYS MALE MINIFIT CONNECTOR	1	PZ																																							
IP1385A1	CORNER POLYSTYREN E PACKING 110X80X2000	2.200	M																																							

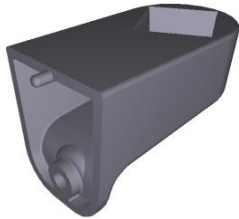
COMPONENT			SPARE PART																																											
Code	Description	Image	Code	Description	Components list																																									
VM1621A	LED BAR UPPER SUPPORT		KLP1004B	L1000 LED BAR KIT	<table border="1"> <thead> <tr> <th>Code</th> <th>Description</th> <th>Qty</th> <th>UOM</th> </tr> </thead> <tbody> <tr> <td>LP1004B0</td> <td>LEB LIGHTING BAR L1000</td> <td>1</td> <td>PZ</td> </tr> <tr> <td>VM1059A1</td> <td>HEAT SHRINK FILM H800</td> <td>1.300</td> <td>M</td> </tr> <tr> <td>VM1620A0</td> <td>LED BAR LOWER SUPPORT</td> <td>1</td> <td>PZ</td> </tr> <tr> <td>VM1621A0</td> <td>LED BAR UPPER SUPPORT</td> <td>1</td> <td>PZ</td> </tr> </tbody> </table>	Code	Description	Qty	UOM	LP1004B0	LEB LIGHTING BAR L1000	1	PZ	VM1059A1	HEAT SHRINK FILM H800	1.300	M	VM1620A0	LED BAR LOWER SUPPORT	1	PZ	VM1621A0	LED BAR UPPER SUPPORT	1	PZ																					
			Code	Description	Qty	UOM																																								
			LP1004B0	LEB LIGHTING BAR L1000	1	PZ																																								
VM1059A1	HEAT SHRINK FILM H800	1.300	M																																											
VM1620A0	LED BAR LOWER SUPPORT	1	PZ																																											
VM1621A0	LED BAR UPPER SUPPORT	1	PZ																																											
KLP1003B	2017 LED BAR KIT	<table border="1"> <thead> <tr> <th>Code</th> <th>Description</th> <th>Qty</th> <th>UOM</th> </tr> </thead> <tbody> <tr> <td>CE1730A0</td> <td>PVC CABLE NP 2 X AWG22 STYLE 2095</td> <td>1</td> <td>M</td> </tr> <tr> <td>CE1735A0</td> <td>MINIFIT FEMALE END FITTING</td> <td>2</td> <td>PZ</td> </tr> <tr> <td>CE1740A0</td> <td>MINIFIT MALE END FITTING</td> <td>2</td> <td>PZ</td> </tr> <tr> <td>CE1745A0</td> <td>2 WAYS FEMALE MINIFIT CONNECTOR</td> <td>1</td> <td>PZ</td> </tr> <tr> <td>CE1750A0</td> <td>3 WAYS MALE MINIFIT CONNECTOR</td> <td>1</td> <td>PZ</td> </tr> <tr> <td>LP1003B0</td> <td>LED LIGHT BAR L600</td> <td>1</td> <td>PZ</td> </tr> <tr> <td>VM1620A0</td> <td>LED BAR LOWER SUPPORT</td> <td>1</td> <td>PZ</td> </tr> <tr> <td>VM1621A0</td> <td>LED BAR UPPER SUPPORT</td> <td>1</td> <td>PZ</td> </tr> <tr> <td>VM1794A0</td> <td>250X4.8 PA66 BLACK CLAMP</td> <td>2</td> <td>PZ</td> </tr> <tr> <td>VM2103A0</td> <td>CLAMP LOCK</td> <td>2</td> <td>PZ</td> </tr> </tbody> </table>	Code	Description	Qty	UOM	CE1730A0	PVC CABLE NP 2 X AWG22 STYLE 2095	1	M	CE1735A0	MINIFIT FEMALE END FITTING	2	PZ	CE1740A0	MINIFIT MALE END FITTING	2	PZ	CE1745A0	2 WAYS FEMALE MINIFIT CONNECTOR	1	PZ	CE1750A0	3 WAYS MALE MINIFIT CONNECTOR	1	PZ	LP1003B0	LED LIGHT BAR L600	1	PZ	VM1620A0	LED BAR LOWER SUPPORT	1	PZ	VM1621A0	LED BAR UPPER SUPPORT	1	PZ	VM1794A0	250X4.8 PA66 BLACK CLAMP	2	PZ	VM2103A0	CLAMP LOCK	2	PZ
Code	Description	Qty	UOM																																											
CE1730A0	PVC CABLE NP 2 X AWG22 STYLE 2095	1	M																																											
CE1735A0	MINIFIT FEMALE END FITTING	2	PZ																																											
CE1740A0	MINIFIT MALE END FITTING	2	PZ																																											
CE1745A0	2 WAYS FEMALE MINIFIT CONNECTOR	1	PZ																																											
CE1750A0	3 WAYS MALE MINIFIT CONNECTOR	1	PZ																																											
LP1003B0	LED LIGHT BAR L600	1	PZ																																											
VM1620A0	LED BAR LOWER SUPPORT	1	PZ																																											
VM1621A0	LED BAR UPPER SUPPORT	1	PZ																																											
VM1794A0	250X4.8 PA66 BLACK CLAMP	2	PZ																																											
VM2103A0	CLAMP LOCK	2	PZ																																											
KLP1002B	L400 LED BAR KIT	<table border="1"> <thead> <tr> <th>Code</th> <th>Description</th> <th>Qty</th> <th>UOM</th> </tr> </thead> <tbody> <tr> <td>CE1455A0</td> <td>TIP END FITTING</td> <td>2</td> <td>PZ</td> </tr> <tr> <td>CE1730A0</td> <td>PVC CABLE NP 2 X AWG22 STYLE 2095</td> <td>4.500</td> <td>M</td> </tr> <tr> <td>CE1735A0</td> <td>MINIFIT FEMALE END FITTING</td> <td>2</td> <td>PZ</td> </tr> <tr> <td>CE1740A0</td> <td>MINIFIT MALE END FITTING</td> <td>4</td> <td>PZ</td> </tr> <tr> <td>CE1745A0</td> <td>2 WAYS FEMALE MINIFIT CONNECTOR</td> <td>2</td> <td>PZ</td> </tr> </tbody> </table>	Code	Description	Qty	UOM	CE1455A0	TIP END FITTING	2	PZ	CE1730A0	PVC CABLE NP 2 X AWG22 STYLE 2095	4.500	M	CE1735A0	MINIFIT FEMALE END FITTING	2	PZ	CE1740A0	MINIFIT MALE END FITTING	4	PZ	CE1745A0	2 WAYS FEMALE MINIFIT CONNECTOR	2	PZ																				
Code	Description	Qty	UOM																																											
CE1455A0	TIP END FITTING	2	PZ																																											
CE1730A0	PVC CABLE NP 2 X AWG22 STYLE 2095	4.500	M																																											
CE1735A0	MINIFIT FEMALE END FITTING	2	PZ																																											
CE1740A0	MINIFIT MALE END FITTING	4	PZ																																											
CE1745A0	2 WAYS FEMALE MINIFIT CONNECTOR	2	PZ																																											



COMPONENT			SPARE PART																																							
Code	Description	Image	Code	Description	Components list																																					
VM1621A	LED BAR UPPER SUPPORT		KLP1002B	L400 LED BAR KIT	<table border="1"> <thead> <tr> <th>Code</th> <th>Description</th> <th>Qty</th> <th>UOM</th> </tr> </thead> <tbody> <tr> <td>CE1750A0</td> <td>3 WAYS MALE MINIFIT CONNECTOR</td> <td>1</td> <td>PZ</td> </tr> <tr> <td>LP1002B0</td> <td>LED LIGHTING BAR L400</td> <td>1</td> <td>PZ</td> </tr> <tr> <td>VM1620A0</td> <td>LED BAR LOWER SUPPORT</td> <td>1</td> <td>PZ</td> </tr> <tr> <td>VM1621A0</td> <td>LED BAR UPPER SUPPORT</td> <td>1</td> <td>PZ</td> </tr> </tbody> </table>	Code	Description	Qty	UOM	CE1750A0	3 WAYS MALE MINIFIT CONNECTOR	1	PZ	LP1002B0	LED LIGHTING BAR L400	1	PZ	VM1620A0	LED BAR LOWER SUPPORT	1	PZ	VM1621A0	LED BAR UPPER SUPPORT	1	PZ																	
			Code	Description	Qty	UOM																																				
			CE1750A0	3 WAYS MALE MINIFIT CONNECTOR	1	PZ																																				
LP1002B0	LED LIGHTING BAR L400	1	PZ																																							
VM1620A0	LED BAR LOWER SUPPORT	1	PZ																																							
VM1621A0	LED BAR UPPER SUPPORT	1	PZ																																							
KLP1001B	L300 LED BAR KIT	<table border="1"> <thead> <tr> <th>Code</th> <th>Description</th> <th>Qty</th> <th>UOM</th> </tr> </thead> <tbody> <tr> <td>CE1455A0</td> <td>TIP END FITTING</td> <td>2</td> <td>PZ</td> </tr> <tr> <td>CE1730A0</td> <td>PVC CABLE NP 2 X AWG22 STYLE 2095</td> <td>4.500</td> <td>M</td> </tr> <tr> <td>CE1735A0</td> <td>MINIFIT FEMALE END FITTING</td> <td>2</td> <td>PZ</td> </tr> <tr> <td>CE1740A0</td> <td>MINIFIT MALE END FITTING</td> <td>4</td> <td>PZ</td> </tr> <tr> <td>CE1745A0</td> <td>2 WAYS FEMALE MINIFIT CONNECTOR</td> <td>2</td> <td>PZ</td> </tr> <tr> <td>CE1750A0</td> <td>3 WAYS MALE MINIFIT CONNECTOR</td> <td>1</td> <td>PZ</td> </tr> <tr> <td>LP1001B0</td> <td>LED LIGHTING BAR L300</td> <td>1</td> <td>PZ</td> </tr> <tr> <td>VM1620A0</td> <td>LED BAR LOWER SUPPORT</td> <td>1</td> <td>PZ</td> </tr> <tr> <td>VM1621A0</td> <td>LED BAR UPPER SUPPORT</td> <td>1</td> <td>PZ</td> </tr> </tbody> </table>	Code	Description	Qty	UOM	CE1455A0	TIP END FITTING	2	PZ	CE1730A0	PVC CABLE NP 2 X AWG22 STYLE 2095	4.500	M	CE1735A0	MINIFIT FEMALE END FITTING	2	PZ	CE1740A0	MINIFIT MALE END FITTING	4	PZ	CE1745A0	2 WAYS FEMALE MINIFIT CONNECTOR	2	PZ	CE1750A0	3 WAYS MALE MINIFIT CONNECTOR	1	PZ	LP1001B0	LED LIGHTING BAR L300	1	PZ	VM1620A0	LED BAR LOWER SUPPORT	1	PZ	VM1621A0	LED BAR UPPER SUPPORT	1	PZ
Code	Description	Qty	UOM																																							
CE1455A0	TIP END FITTING	2	PZ																																							
CE1730A0	PVC CABLE NP 2 X AWG22 STYLE 2095	4.500	M																																							
CE1735A0	MINIFIT FEMALE END FITTING	2	PZ																																							
CE1740A0	MINIFIT MALE END FITTING	4	PZ																																							
CE1745A0	2 WAYS FEMALE MINIFIT CONNECTOR	2	PZ																																							
CE1750A0	3 WAYS MALE MINIFIT CONNECTOR	1	PZ																																							
LP1001B0	LED LIGHTING BAR L300	1	PZ																																							
VM1620A0	LED BAR LOWER SUPPORT	1	PZ																																							
VM1621A0	LED BAR UPPER SUPPORT	1	PZ																																							
KLP1000A	L100 LED BAR KIT	<table border="1"> <thead> <tr> <th>Code</th> <th>Description</th> <th>Qty</th> <th>UOM</th> </tr> </thead> <tbody> <tr> <td>LP1000A0</td> <td>LED LIGHTING BAR L100</td> <td>1</td> <td>PZ</td> </tr> <tr> <td>VM1620A0</td> <td>LED BAR LOWER SUPPORT</td> <td>1</td> <td>PZ</td> </tr> <tr> <td>VM1621A0</td> <td>LED BAR UPPER SUPPORT</td> <td>1</td> <td>PZ</td> </tr> </tbody> </table>	Code	Description	Qty	UOM	LP1000A0	LED LIGHTING BAR L100	1	PZ	VM1620A0	LED BAR LOWER SUPPORT	1	PZ	VM1621A0	LED BAR UPPER SUPPORT	1	PZ																								
Code	Description	Qty	UOM																																							
LP1000A0	LED LIGHTING BAR L100	1	PZ																																							
VM1620A0	LED BAR LOWER SUPPORT	1	PZ																																							
VM1621A0	LED BAR UPPER SUPPORT	1	PZ																																							







COMPONENT			SPARE PART																																										
Code	Description	Image	Code	Description	Components list																																								
LP1044A	LUX LED BAR		KLP1044A	LUX LED BAR KIT	<table border="1"> <thead> <tr> <th>Code</th> <th>Description</th> <th>Qty</th> <th>UOM</th> </tr> </thead> <tbody> <tr> <td>CE1455A0</td> <td>TIP END FITTING</td> <td>2</td> <td>PZ</td> </tr> <tr> <td>CE1730A0</td> <td>PVC CABLE NP 2 X AWG22 STYLE 2095</td> <td>4.500</td> <td>M</td> </tr> <tr> <td>CE1735A0</td> <td>MINIFIT FEMALE END FITTING</td> <td>2</td> <td>PZ</td> </tr> <tr> <td>CE1740A0</td> <td>MINIFIT MALE END FITTING</td> <td>4</td> <td>PZ</td> </tr> <tr> <td>CE1745A0</td> <td>2 WAYS FEMALE MINIFIT CONNECTOR</td> <td>2</td> <td>PZ</td> </tr> <tr> <td>CE1750A0</td> <td>3 WAYS MALE MINIFIT CONNECTOR</td> <td>1</td> <td>PZ</td> </tr> <tr> <td>LP1044A0</td> <td>LUX LED BAR</td> <td>1</td> <td>PZ</td> </tr> <tr> <td>VM1620A0</td> <td>LED BAR LOWER SUPPORT</td> <td>1</td> <td>PZ</td> </tr> <tr> <td>VM1621A0</td> <td>LED BAR UPPER SUPPORT</td> <td>1</td> <td>PZ</td> </tr> </tbody> </table>	Code	Description	Qty	UOM	CE1455A0	TIP END FITTING	2	PZ	CE1730A0	PVC CABLE NP 2 X AWG22 STYLE 2095	4.500	M	CE1735A0	MINIFIT FEMALE END FITTING	2	PZ	CE1740A0	MINIFIT MALE END FITTING	4	PZ	CE1745A0	2 WAYS FEMALE MINIFIT CONNECTOR	2	PZ	CE1750A0	3 WAYS MALE MINIFIT CONNECTOR	1	PZ	LP1044A0	LUX LED BAR	1	PZ	VM1620A0	LED BAR LOWER SUPPORT	1	PZ	VM1621A0	LED BAR UPPER SUPPORT	1	PZ
Code	Description	Qty	UOM																																										
CE1455A0	TIP END FITTING	2	PZ																																										
CE1730A0	PVC CABLE NP 2 X AWG22 STYLE 2095	4.500	M																																										
CE1735A0	MINIFIT FEMALE END FITTING	2	PZ																																										
CE1740A0	MINIFIT MALE END FITTING	4	PZ																																										
CE1745A0	2 WAYS FEMALE MINIFIT CONNECTOR	2	PZ																																										
CE1750A0	3 WAYS MALE MINIFIT CONNECTOR	1	PZ																																										
LP1044A0	LUX LED BAR	1	PZ																																										
VM1620A0	LED BAR LOWER SUPPORT	1	PZ																																										
VM1621A0	LED BAR UPPER SUPPORT	1	PZ																																										
VM2008A	SPACER FOR MICROSWITCH		KVM2008A	MICROSWITCH SPACER KIT	<table border="1"> <thead> <tr> <th>Code</th> <th>Description</th> <th>Qty</th> <th>UOM</th> </tr> </thead> <tbody> <tr> <td>VM1224A0</td> <td>65MY 220MM COLOURS SHRINK TUBE</td> <td>2 0.200</td> <td>M</td> </tr> <tr> <td>VM2008A0</td> <td>SPACER FOR MICROSWITC</td> <td>2</td> <td>PZ</td> </tr> </tbody> </table>	Code	Description	Qty	UOM	VM1224A0	65MY 220MM COLOURS SHRINK TUBE	2 0.200	M	VM2008A0	SPACER FOR MICROSWITC	2	PZ																												
Code	Description	Qty	UOM																																										
VM1224A0	65MY 220MM COLOURS SHRINK TUBE	2 0.200	M																																										
VM2008A0	SPACER FOR MICROSWITC	2	PZ																																										
TB3095A	BL CL 89 RIGHT COLUMN		TB3095A0	BL CL 89 RIGHT COLUMN																																									







COMPONENT			SPARE PART																																		
Code	Description	Image	Code	Description	Components list																																
TB3093A	BL CL 89 LEFT COLUMN		TB3093A0	BL CL 89 LEFT COLUMN																																	
VT1254A	OUTER GLASS XB89- XC89-		KVT1254AR	XB89-XV893 LED EXTERNAL GLASS KIT	<table border="1"> <thead> <tr> <th>Code</th> <th>Description</th> <th>Qty</th> <th>UOM</th> </tr> </thead> <tbody> <tr> <td>0H7530A0</td> <td>XB89- XV EXTERNAL GLASS HOLDING PROFILE</td> <td>2</td> <td>PZ</td> </tr> <tr> <td>IP1385A1</td> <td>CORNER POLYSTYRENE PACKING 110X80X2000</td> <td>3.450</td> <td>M</td> </tr> <tr> <td>IP1508A1</td> <td>POLYSTYRENE U SHAPED PROFILE 2000X60X60</td> <td>3</td> <td>M</td> </tr> <tr> <td>SL1156A0</td> <td>NOZZLE FOR SILICON GUN</td> <td>1.200</td> <td>PZ</td> </tr> <tr> <td>VM1059A1</td> <td>HEAT SHRINK FILM H800</td> <td>1.700</td> <td>M</td> </tr> <tr> <td>VT1254A0</td> <td>OUTER GLASS XB89- XC89-</td> <td>1</td> <td>PZ</td> </tr> <tr> <td>VT1254A0</td> <td>OUTER GLASS XB89- XC89-</td> <td>1</td> <td>PZ</td> </tr> </tbody> </table>	Code	Description	Qty	UOM	0H7530A0	XB89- XV EXTERNAL GLASS HOLDING PROFILE	2	PZ	IP1385A1	CORNER POLYSTYRENE PACKING 110X80X2000	3.450	M	IP1508A1	POLYSTYRENE U SHAPED PROFILE 2000X60X60	3	M	SL1156A0	NOZZLE FOR SILICON GUN	1.200	PZ	VM1059A1	HEAT SHRINK FILM H800	1.700	M	VT1254A0	OUTER GLASS XB89- XC89-	1	PZ	VT1254A0	OUTER GLASS XB89- XC89-	1	PZ
Code	Description	Qty	UOM																																		
0H7530A0	XB89- XV EXTERNAL GLASS HOLDING PROFILE	2	PZ																																		
IP1385A1	CORNER POLYSTYRENE PACKING 110X80X2000	3.450	M																																		
IP1508A1	POLYSTYRENE U SHAPED PROFILE 2000X60X60	3	M																																		
SL1156A0	NOZZLE FOR SILICON GUN	1.200	PZ																																		
VM1059A1	HEAT SHRINK FILM H800	1.700	M																																		
VT1254A0	OUTER GLASS XB89- XC89-	1	PZ																																		
VT1254A0	OUTER GLASS XB89- XC89-	1	PZ																																		
			KVT1254A	XB89- XV893 EXTERNAL GLASS KIT	<table border="1"> <thead> <tr> <th>Code</th> <th>Description</th> <th>Qty</th> <th>UOM</th> </tr> </thead> <tbody> <tr> <td>0H6575A1</td> <td>XB89- XV EXTERNAL GLASS HOLDING PROFILE</td> <td>2</td> <td>PZ</td> </tr> <tr> <td>IP1385A1</td> <td>CORNER POLYSTYRENE PACKING 110X80X2000</td> <td>2.180</td> <td>M</td> </tr> <tr> <td>IP1508A1</td> <td>POLYSTYRENE U SHAPED PROFILE 2000X60X60</td> <td>1.270</td> <td>M</td> </tr> <tr> <td>SL1155A1</td> <td>LOCTITE BICOMPONENT SILICON</td> <td>0.200</td> <td>ML</td> </tr> <tr> <td>SL1156A0</td> <td>NOZZLE FOR SILICON GUN</td> <td>1</td> <td>PZ</td> </tr> <tr> <td>VT1254A0</td> <td>OUTER GLASS XB89- XC89-</td> <td>1</td> <td>PZ</td> </tr> <tr> <td>VT1254A0</td> <td>OUTER GLASS XB89- XC89-</td> <td>1</td> <td>PZ</td> </tr> </tbody> </table>	Code	Description	Qty	UOM	0H6575A1	XB89- XV EXTERNAL GLASS HOLDING PROFILE	2	PZ	IP1385A1	CORNER POLYSTYRENE PACKING 110X80X2000	2.180	M	IP1508A1	POLYSTYRENE U SHAPED PROFILE 2000X60X60	1.270	M	SL1155A1	LOCTITE BICOMPONENT SILICON	0.200	ML	SL1156A0	NOZZLE FOR SILICON GUN	1	PZ	VT1254A0	OUTER GLASS XB89- XC89-	1	PZ	VT1254A0	OUTER GLASS XB89- XC89-	1	PZ
Code	Description	Qty	UOM																																		
0H6575A1	XB89- XV EXTERNAL GLASS HOLDING PROFILE	2	PZ																																		
IP1385A1	CORNER POLYSTYRENE PACKING 110X80X2000	2.180	M																																		
IP1508A1	POLYSTYRENE U SHAPED PROFILE 2000X60X60	1.270	M																																		
SL1155A1	LOCTITE BICOMPONENT SILICON	0.200	ML																																		
SL1156A0	NOZZLE FOR SILICON GUN	1	PZ																																		
VT1254A0	OUTER GLASS XB89- XC89-	1	PZ																																		
VT1254A0	OUTER GLASS XB89- XC89-	1	PZ																																		

COMPONENT			SPARE PART																																																		
Code	Description	Image	Code	Description	Components list																																																
VM2000A	M4 SOCKET HEAD SCREW COVER		VM2000A0	M4 SOCKET HEAD SCREW COVER																																																	
CR1085A	INTERNAL GLASS UPPER HINGE		KVM0012A	4-5-5E S. INT. GLASS OPENING SYSTEM KIT	<table border="1"> <thead> <tr> <th>Code</th> <th>Description</th> <th>Qty</th> <th>UOM</th> </tr> </thead> <tbody> <tr> <td>CR1085A0</td> <td>INTERNAL GLASS UPPER HINGE</td> <td>1</td> <td>PZ</td> </tr> <tr> <td>CR1086A0</td> <td>INTERNAL GLASS LOWER HINGE</td> <td>1</td> <td>PZ</td> </tr> <tr> <td>GN1181A0</td> <td>INTERNAL GLASS HINGE SEAL</td> <td>2</td> <td>PZ</td> </tr> <tr> <td>VI1220A1</td> <td>4,2X12 TCB SELF-TAPPING SCREW</td> <td>5</td> <td>PZ</td> </tr> <tr> <td>VI1300A0</td> <td>SCREW M6X12 T1/2T+INOX</td> <td>4</td> <td>PZ</td> </tr> <tr> <td>VI1810A0</td> <td>M6X6 STAINLESS STEEL FLATHEAD SCREW</td> <td>6</td> <td>PZ</td> </tr> <tr> <td>VI1950A0</td> <td>ST. STEEL 4,2X13 TCB SELF-DRILLING SCREW</td> <td>6</td> <td>PZ</td> </tr> <tr> <td>VM1224A0</td> <td>65MY 220MM 2 COLOURS SHRINK TUBE</td> <td>0.300</td> <td>M</td> </tr> <tr> <td>VM1680A0</td> <td>INTERNAL GLASS HINGE</td> <td>2</td> <td>PZ</td> </tr> <tr> <td>VM2042A0</td> <td>INTERNAL GLASS LATERAL LOCKING SYSTEM</td> <td>2</td> <td>PZ</td> </tr> <tr> <td>VM2043A0</td> <td>UPPER - LOWER GLASS SUPPORT</td> <td>2</td> <td>PZ</td> </tr> </tbody> </table>	Code	Description	Qty	UOM	CR1085A0	INTERNAL GLASS UPPER HINGE	1	PZ	CR1086A0	INTERNAL GLASS LOWER HINGE	1	PZ	GN1181A0	INTERNAL GLASS HINGE SEAL	2	PZ	VI1220A1	4,2X12 TCB SELF-TAPPING SCREW	5	PZ	VI1300A0	SCREW M6X12 T1/2T+INOX	4	PZ	VI1810A0	M6X6 STAINLESS STEEL FLATHEAD SCREW	6	PZ	VI1950A0	ST. STEEL 4,2X13 TCB SELF-DRILLING SCREW	6	PZ	VM1224A0	65MY 220MM 2 COLOURS SHRINK TUBE	0.300	M	VM1680A0	INTERNAL GLASS HINGE	2	PZ	VM2042A0	INTERNAL GLASS LATERAL LOCKING SYSTEM	2	PZ	VM2043A0	UPPER - LOWER GLASS SUPPORT	2	PZ
Code	Description	Qty	UOM																																																		
CR1085A0	INTERNAL GLASS UPPER HINGE	1	PZ																																																		
CR1086A0	INTERNAL GLASS LOWER HINGE	1	PZ																																																		
GN1181A0	INTERNAL GLASS HINGE SEAL	2	PZ																																																		
VI1220A1	4,2X12 TCB SELF-TAPPING SCREW	5	PZ																																																		
VI1300A0	SCREW M6X12 T1/2T+INOX	4	PZ																																																		
VI1810A0	M6X6 STAINLESS STEEL FLATHEAD SCREW	6	PZ																																																		
VI1950A0	ST. STEEL 4,2X13 TCB SELF-DRILLING SCREW	6	PZ																																																		
VM1224A0	65MY 220MM 2 COLOURS SHRINK TUBE	0.300	M																																																		
VM1680A0	INTERNAL GLASS HINGE	2	PZ																																																		
VM2042A0	INTERNAL GLASS LATERAL LOCKING SYSTEM	2	PZ																																																		
VM2043A0	UPPER - LOWER GLASS SUPPORT	2	PZ																																																		
			KCR1085A	INTERNAL GLASS UPPER HINGE KIT	<table border="1"> <thead> <tr> <th>Code</th> <th>Description</th> <th>Qty</th> <th>UOM</th> </tr> </thead> <tbody> <tr> <td>CR1085A0</td> <td>INTERNAL GLASS UPPER HINGE</td> <td>1</td> <td>PZ</td> </tr> <tr> <td>GN1181A0</td> <td>INTERNAL GLASS HINGE SEAL</td> <td>1</td> <td>PZ</td> </tr> </tbody> </table>	Code	Description	Qty	UOM	CR1085A0	INTERNAL GLASS UPPER HINGE	1	PZ	GN1181A0	INTERNAL GLASS HINGE SEAL	1	PZ																																				
Code	Description	Qty	UOM																																																		
CR1085A0	INTERNAL GLASS UPPER HINGE	1	PZ																																																		
GN1181A0	INTERNAL GLASS HINGE SEAL	1	PZ																																																		

COMPONENT			SPARE PART																										
Code	Description	Image	Code	Description	Components list																								
CR1085A	INTERNAL GLASS UPPER HINGE		KCR1085A	INTERNAL GLASS UPPER HINGE KIT	<table border="1"> <thead> <tr> <th>Code</th> <th>Description</th> <th>Qty</th> <th>UOM</th> </tr> </thead> <tbody> <tr> <td>VI1810A0</td> <td>M6X6 STAINLESS STEEL FLATHEAD SCREW</td> <td>3</td> <td>PZ</td> </tr> <tr> <td>VM1224A0</td> <td>65MY 220MM 2 COLOURS SHRINK TUBE</td> <td>0.200</td> <td>M</td> </tr> </tbody> </table>	Code	Description	Qty	UOM	VI1810A0	M6X6 STAINLESS STEEL FLATHEAD SCREW	3	PZ	VM1224A0	65MY 220MM 2 COLOURS SHRINK TUBE	0.200	M												
Code	Description	Qty	UOM																										
VI1810A0	M6X6 STAINLESS STEEL FLATHEAD SCREW	3	PZ																										
VM1224A0	65MY 220MM 2 COLOURS SHRINK TUBE	0.200	M																										
GN1181A	INTERNAL GLASS HINGE SEAL		KG1181A	INT. GLASS HINGE GASKET 2 PCS KIT	<table border="1"> <thead> <tr> <th>Code</th> <th>Description</th> <th>Qty</th> <th>UOM</th> </tr> </thead> <tbody> <tr> <td>GN1181A0</td> <td>INTERNAL GLASS HINGE SEAL</td> <td>2</td> <td>PZ</td> </tr> <tr> <td>VM1224A0</td> <td>65MY 220MM 2 COLOURS SHRINK TUBE</td> <td>0.200</td> <td>M</td> </tr> </tbody> </table>	Code	Description	Qty	UOM	GN1181A0	INTERNAL GLASS HINGE SEAL	2	PZ	VM1224A0	65MY 220MM 2 COLOURS SHRINK TUBE	0.200	M												
Code	Description	Qty	UOM																										
GN1181A0	INTERNAL GLASS HINGE SEAL	2	PZ																										
VM1224A0	65MY 220MM 2 COLOURS SHRINK TUBE	0.200	M																										
VM2000A	M4 SOCKET HEAD SCREW COVER		VM2000A0	M4 SOCKET HEAD SCREW COVER																									
GN1181A	INTERNAL GLASS HINGE SEAL		KG1181A	INT. GLASS HINGE GASKET 2 PCS KIT	<table border="1"> <thead> <tr> <th>Code</th> <th>Description</th> <th>Qty</th> <th>UOM</th> </tr> </thead> <tbody> <tr> <td>GN1181A0</td> <td>INTERNAL GLASS HINGE SEAL</td> <td>2</td> <td>PZ</td> </tr> <tr> <td>VM1224A0</td> <td>65MY 220MM 2 COLOURS SHRINK TUBE</td> <td>0.200</td> <td>M</td> </tr> </tbody> </table>	Code	Description	Qty	UOM	GN1181A0	INTERNAL GLASS HINGE SEAL	2	PZ	VM1224A0	65MY 220MM 2 COLOURS SHRINK TUBE	0.200	M												
Code	Description	Qty	UOM																										
GN1181A0	INTERNAL GLASS HINGE SEAL	2	PZ																										
VM1224A0	65MY 220MM 2 COLOURS SHRINK TUBE	0.200	M																										
CR1086A	INTERNAL GLASS LOWER HINGE		KVM0012A	4-5-5E S. INT. GLASS OPENING SYSTEM KIT	<table border="1"> <thead> <tr> <th>Code</th> <th>Description</th> <th>Qty</th> <th>UOM</th> </tr> </thead> <tbody> <tr> <td>CR1085A0</td> <td>INTERNAL GLASS UPPER HINGE</td> <td>1</td> <td>PZ</td> </tr> <tr> <td>CR1086A0</td> <td>INTERNAL GLASS LOWER HINGE</td> <td>1</td> <td>PZ</td> </tr> <tr> <td>GN1181A0</td> <td>INTERNAL GLASS HINGE SEAL</td> <td>2</td> <td>PZ</td> </tr> <tr> <td>VI1220A1</td> <td>4,2X12 TCB SELF-TAPPING SCREW</td> <td>5</td> <td>PZ</td> </tr> <tr> <td>VI1300A0</td> <td>SCREW M6X12 T1/2T+INOX</td> <td>4</td> <td>PZ</td> </tr> </tbody> </table>	Code	Description	Qty	UOM	CR1085A0	INTERNAL GLASS UPPER HINGE	1	PZ	CR1086A0	INTERNAL GLASS LOWER HINGE	1	PZ	GN1181A0	INTERNAL GLASS HINGE SEAL	2	PZ	VI1220A1	4,2X12 TCB SELF-TAPPING SCREW	5	PZ	VI1300A0	SCREW M6X12 T1/2T+INOX	4	PZ
Code	Description	Qty	UOM																										
CR1085A0	INTERNAL GLASS UPPER HINGE	1	PZ																										
CR1086A0	INTERNAL GLASS LOWER HINGE	1	PZ																										
GN1181A0	INTERNAL GLASS HINGE SEAL	2	PZ																										
VI1220A1	4,2X12 TCB SELF-TAPPING SCREW	5	PZ																										
VI1300A0	SCREW M6X12 T1/2T+INOX	4	PZ																										

COMPONENT			SPARE PART																														
Code	Description	Image	Code	Description	Components list																												
CR1086A	INTERNAL GLASS LOWER HINGE		KVM0012A	4-5-5E S. INT. GLASS OPENING SYSTEM KIT	<table border="1"> <thead> <tr> <th>Code</th> <th>Description</th> <th>Qty</th> <th>UOM</th> </tr> </thead> <tbody> <tr> <td>VI1810A0</td> <td>M6X6 STAINLESS STEEL FLATHEAD SCREW</td> <td>6</td> <td>PZ</td> </tr> <tr> <td>VI1950A0</td> <td>ST. STEEL 4,2X13 TCB SELF-DRILLIN G SCREW</td> <td>6</td> <td>PZ</td> </tr> <tr> <td>VM1224A0</td> <td>65MY 220MM 2 COLOURS SHRINK TUBE</td> <td>0.300</td> <td>M</td> </tr> <tr> <td>VM1680A0</td> <td>INTERNAL GLASS HINGE</td> <td>2</td> <td>PZ</td> </tr> <tr> <td>VM2042A0</td> <td>INTERNAL GLASS LATERAL LOCKING SYSTEM</td> <td>2</td> <td>PZ</td> </tr> <tr> <td>VM2043A0</td> <td>UPPER - LOWER GLASS SUPPORT</td> <td>2</td> <td>PZ</td> </tr> </tbody> </table>	Code	Description	Qty	UOM	VI1810A0	M6X6 STAINLESS STEEL FLATHEAD SCREW	6	PZ	VI1950A0	ST. STEEL 4,2X13 TCB SELF-DRILLIN G SCREW	6	PZ	VM1224A0	65MY 220MM 2 COLOURS SHRINK TUBE	0.300	M	VM1680A0	INTERNAL GLASS HINGE	2	PZ	VM2042A0	INTERNAL GLASS LATERAL LOCKING SYSTEM	2	PZ	VM2043A0	UPPER - LOWER GLASS SUPPORT	2	PZ
			Code	Description	Qty	UOM																											
VI1810A0	M6X6 STAINLESS STEEL FLATHEAD SCREW	6	PZ																														
VI1950A0	ST. STEEL 4,2X13 TCB SELF-DRILLIN G SCREW	6	PZ																														
VM1224A0	65MY 220MM 2 COLOURS SHRINK TUBE	0.300	M																														
VM1680A0	INTERNAL GLASS HINGE	2	PZ																														
VM2042A0	INTERNAL GLASS LATERAL LOCKING SYSTEM	2	PZ																														
VM2043A0	UPPER - LOWER GLASS SUPPORT	2	PZ																														
KCR1086A	INTERNAL GLASS LOWER HINGE KIT	<table border="1"> <thead> <tr> <th>Code</th> <th>Description</th> <th>Qty</th> <th>UOM</th> </tr> </thead> <tbody> <tr> <td>CR1086A0</td> <td>INTERNAL GLASS LOWER HINGE</td> <td>1</td> <td>PZ</td> </tr> <tr> <td>GN1181A0</td> <td>INTERNAL GLASS HINGE SEAL</td> <td>1</td> <td>PZ</td> </tr> <tr> <td>VI1810A0</td> <td>M6X6 STAINLESS STEEL FLATHEAD SCREW</td> <td>3</td> <td>PZ</td> </tr> <tr> <td>VM1224A0</td> <td>65MY 220MM 2 COLOURS SHRINK TUBE</td> <td>0.200</td> <td>M</td> </tr> </tbody> </table>	Code	Description	Qty	UOM	CR1086A0	INTERNAL GLASS LOWER HINGE	1	PZ	GN1181A0	INTERNAL GLASS HINGE SEAL	1	PZ	VI1810A0	M6X6 STAINLESS STEEL FLATHEAD SCREW	3	PZ	VM1224A0	65MY 220MM 2 COLOURS SHRINK TUBE	0.200	M											
Code	Description	Qty	UOM																														
CR1086A0	INTERNAL GLASS LOWER HINGE	1	PZ																														
GN1181A0	INTERNAL GLASS HINGE SEAL	1	PZ																														
VI1810A0	M6X6 STAINLESS STEEL FLATHEAD SCREW	3	PZ																														
VM1224A0	65MY 220MM 2 COLOURS SHRINK TUBE	0.200	M																														
VT1140A	XB893/895 XBC804/805 INTERNAL GLASS		KVT1140A	XB893/895 XBC804/805 INTERNAL GLASS KI	<table border="1"> <thead> <tr> <th>Code</th> <th>Description</th> <th>Qty</th> <th>UOM</th> </tr> </thead> <tbody> <tr> <td>IP1508A1</td> <td>POLYSTYREN E U SHAPED PROFILE 2000X60X60</td> <td>2</td> <td>M</td> </tr> <tr> <td>VM1059A1</td> <td>HEAT SHRINK FILM H800</td> <td>1.500</td> <td>M</td> </tr> <tr> <td>VT1140A0</td> <td>XB893/895 XBC804/805 INTERNAL GLASS</td> <td>1</td> <td>PZ</td> </tr> <tr> <td>VT1140A0</td> <td>XB893/895 XBC804/805 INTERNAL GLASS</td> <td>1</td> <td>PZ</td> </tr> </tbody> </table>	Code	Description	Qty	UOM	IP1508A1	POLYSTYREN E U SHAPED PROFILE 2000X60X60	2	M	VM1059A1	HEAT SHRINK FILM H800	1.500	M	VT1140A0	XB893/895 XBC804/805 INTERNAL GLASS	1	PZ	VT1140A0	XB893/895 XBC804/805 INTERNAL GLASS	1	PZ								
			Code	Description	Qty	UOM																											
			IP1508A1	POLYSTYREN E U SHAPED PROFILE 2000X60X60	2	M																											
			VM1059A1	HEAT SHRINK FILM H800	1.500	M																											
VT1140A0	XB893/895 XBC804/805 INTERNAL GLASS	1	PZ																														
VT1140A0	XB893/895 XBC804/805 INTERNAL GLASS	1	PZ																														



COMPONENT			SPARE PART																																																																														
Code	Description	Image	Code	Description	Components list																																																																												
MG1083A	MIND.MAPS DOOR COMPLETE HANDLE		KMG1083A	MIND.MAPS SERIES HANDLE KIT	<table border="1"> <thead> <tr> <th>Code</th> <th>Description</th> <th>Qty</th> <th>UOM</th> </tr> </thead> <tbody> <tr> <td>0H7321A0</td> <td>MM STAINLESS STEEL HANDLE COVE</td> <td>1</td> <td>PZ</td> </tr> <tr> <td>MG1083A2</td> <td></td> <td>1</td> <td>PZ</td> </tr> <tr> <td>MOV0006A0</td> <td>HOOD RING GASKET GN1110A2</td> <td>0.100</td> <td>PZ</td> </tr> <tr> <td>RC1200A0</td> <td>ED=4 WIRE D.=0.5 COMPRESSIO N SPRING</td> <td>4</td> <td>PZ</td> </tr> <tr> <td>VI0239A1</td> <td>SELF-TAPPIN G SCREW 4.2X25 TCB+ INOX</td> <td>8</td> <td>PZ</td> </tr> <tr> <td>VI1220A1</td> <td>4,2X12 TCB SELF-TAPPIN G SCREW</td> <td>2</td> <td>PZ</td> </tr> <tr> <td>VM1182B1</td> <td>E.S. CT BT HANDLE JUNCTION + PIN GUIDE</td> <td>1</td> <td>PZ</td> </tr> <tr> <td>VM1183B0</td> <td>CHEFTOP/BAK ERTOP HANDLE PIN</td> <td>1</td> <td>PZ</td> </tr> <tr> <td>VM1183B1</td> <td>CT BT HANDLE PIN</td> <td>1</td> <td>PZ</td> </tr> <tr> <td>VM1183C0</td> <td>CT BT HANDLE T-SHAPED PIN KIT</td> <td>1</td> <td>PZ</td> </tr> <tr> <td>VM1183C1</td> <td>CT BT HANDLE T-SHAPED PIN KIT</td> <td>1</td> <td>PZ</td> </tr> <tr> <td>VM1490A0</td> <td>CHEFTOP/BAK ERTOP HANDLE SCREWS COVER</td> <td>2</td> <td>PZ</td> </tr> <tr> <td>VM1695A0</td> <td>HANDLE POSITION PIN</td> <td>4</td> <td>PZ</td> </tr> <tr> <td>VM2245A0</td> <td>HANDLE SHAFT WITH LATCH</td> <td>1</td> <td>PZ</td> </tr> <tr> <td>VM2247A0</td> <td>HANDLE SHAFT COVER VM2245-2246</td> <td>1</td> <td>PZ</td> </tr> <tr> <td>VM2247B0</td> <td>HANDLE SHAFT COVER VM2245-2246</td> <td>1</td> <td>PZ</td> </tr> <tr> <td>VM2248B0</td> <td>HANDLE WITH LATCH CLOSING KEY</td> <td>1</td> <td>PZ</td> </tr> <tr> <td>VM2295A0</td> <td>STYLUS PEN FOR MM</td> <td>1</td> <td>PZ</td> </tr> </tbody> </table>	Code	Description	Qty	UOM	0H7321A0	MM STAINLESS STEEL HANDLE COVE	1	PZ	MG1083A2		1	PZ	MOV0006A0	HOOD RING GASKET GN1110A2	0.100	PZ	RC1200A0	ED=4 WIRE D.=0.5 COMPRESSIO N SPRING	4	PZ	VI0239A1	SELF-TAPPIN G SCREW 4.2X25 TCB+ INOX	8	PZ	VI1220A1	4,2X12 TCB SELF-TAPPIN G SCREW	2	PZ	VM1182B1	E.S. CT BT HANDLE JUNCTION + PIN GUIDE	1	PZ	VM1183B0	CHEFTOP/BAK ERTOP HANDLE PIN	1	PZ	VM1183B1	CT BT HANDLE PIN	1	PZ	VM1183C0	CT BT HANDLE T-SHAPED PIN KIT	1	PZ	VM1183C1	CT BT HANDLE T-SHAPED PIN KIT	1	PZ	VM1490A0	CHEFTOP/BAK ERTOP HANDLE SCREWS COVER	2	PZ	VM1695A0	HANDLE POSITION PIN	4	PZ	VM2245A0	HANDLE SHAFT WITH LATCH	1	PZ	VM2247A0	HANDLE SHAFT COVER VM2245-2246	1	PZ	VM2247B0	HANDLE SHAFT COVER VM2245-2246	1	PZ	VM2248B0	HANDLE WITH LATCH CLOSING KEY	1	PZ	VM2295A0	STYLUS PEN FOR MM	1	PZ
					Code	Description	Qty	UOM																																																																									
					0H7321A0	MM STAINLESS STEEL HANDLE COVE	1	PZ																																																																									
					MG1083A2		1	PZ																																																																									
					MOV0006A0	HOOD RING GASKET GN1110A2	0.100	PZ																																																																									
					RC1200A0	ED=4 WIRE D.=0.5 COMPRESSIO N SPRING	4	PZ																																																																									
					VI0239A1	SELF-TAPPIN G SCREW 4.2X25 TCB+ INOX	8	PZ																																																																									
					VI1220A1	4,2X12 TCB SELF-TAPPIN G SCREW	2	PZ																																																																									
					VM1182B1	E.S. CT BT HANDLE JUNCTION + PIN GUIDE	1	PZ																																																																									
					VM1183B0	CHEFTOP/BAK ERTOP HANDLE PIN	1	PZ																																																																									
					VM1183B1	CT BT HANDLE PIN	1	PZ																																																																									
					VM1183C0	CT BT HANDLE T-SHAPED PIN KIT	1	PZ																																																																									
					VM1183C1	CT BT HANDLE T-SHAPED PIN KIT	1	PZ																																																																									
					VM1490A0	CHEFTOP/BAK ERTOP HANDLE SCREWS COVER	2	PZ																																																																									
					VM1695A0	HANDLE POSITION PIN	4	PZ																																																																									
					VM2245A0	HANDLE SHAFT WITH LATCH	1	PZ																																																																									
					VM2247A0	HANDLE SHAFT COVER VM2245-2246	1	PZ																																																																									
					VM2247B0	HANDLE SHAFT COVER VM2245-2246	1	PZ																																																																									
					VM2248B0	HANDLE WITH LATCH CLOSING KEY	1	PZ																																																																									
					VM2295A0	STYLUS PEN FOR MM	1	PZ																																																																									



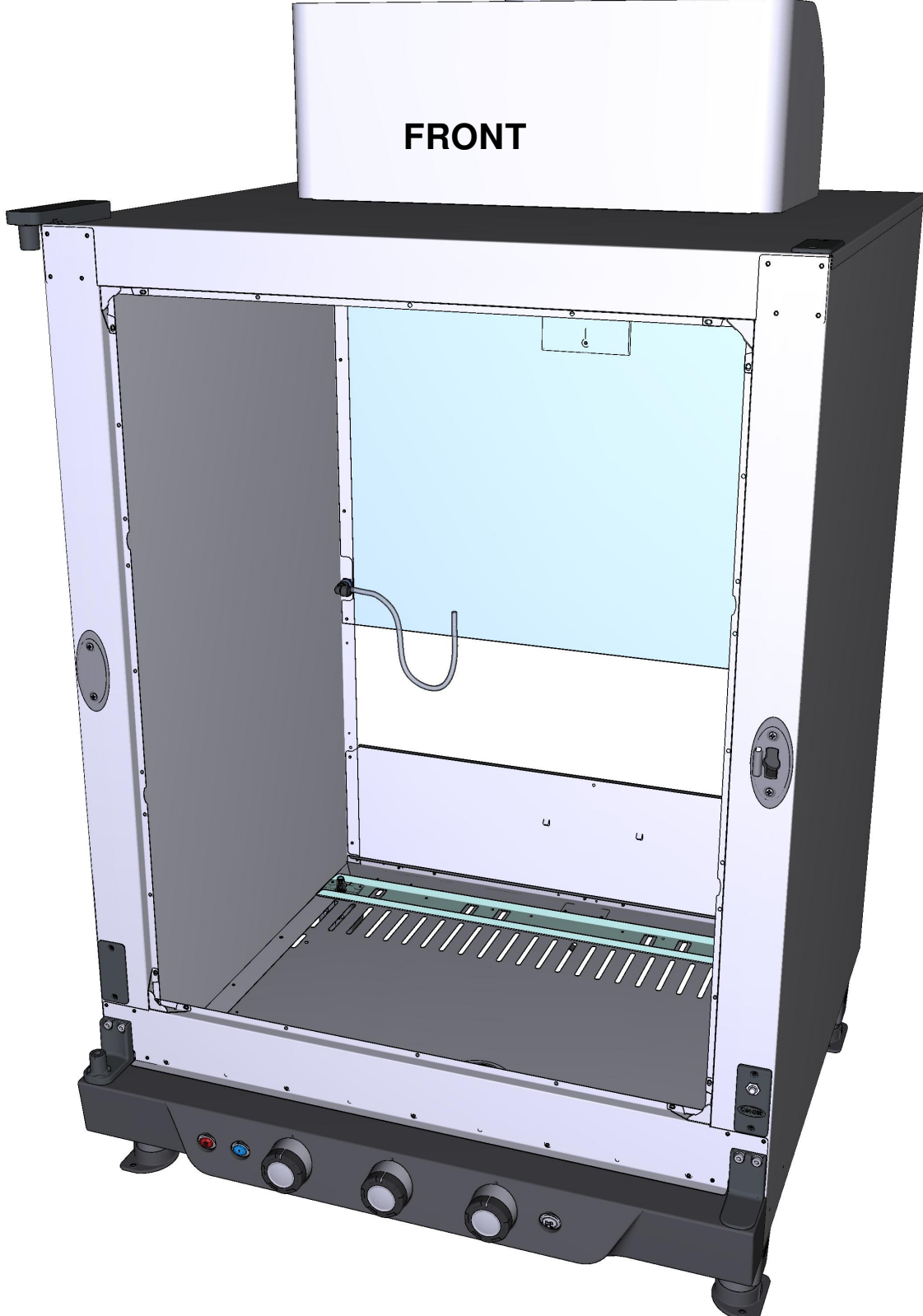

ASM2110A/0.D00 - External cover



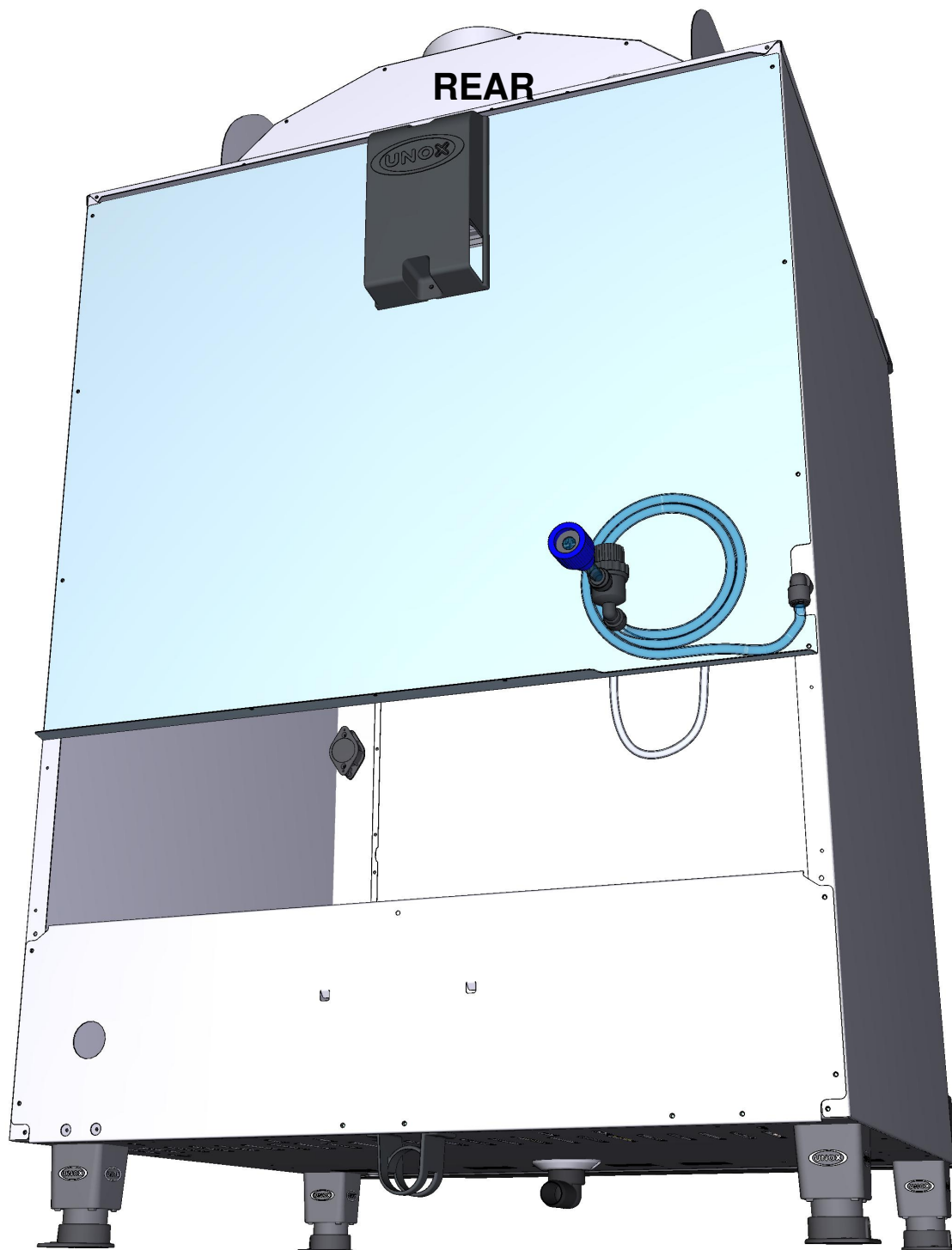





ASM2110A/0.D00 - External cover



COMPONENT			SPARE PART																										
Code	Description	Image	Code	Description	Components list																								
0H1450A	XB-XV-XG ST. STEEL MUFFLE FRONT CORNER		0H1450A0	XB-XV-XG ST. STEEL MUFFLE FRONT CORNER																									
VI1081A	M6X25 STAINLESS STEEL SCREW		KVI1081A	10PCS. M6X25 ST.STEEL SCREW KI	<table border="1"> <thead> <tr> <th>Code</th> <th>Description</th> <th>Qty</th> <th>UOM</th> </tr> </thead> <tbody> <tr> <td>VI1081A0</td> <td>M6X25 STAINLESS STEEL SCREW</td> <td>10</td> <td>PZ</td> </tr> <tr> <td>VM1224A0</td> <td>65MY 220MM 2 COLOURS SHRINK TUBE</td> <td>0.200</td> <td>M</td> </tr> </tbody> </table>	Code	Description	Qty	UOM	VI1081A0	M6X25 STAINLESS STEEL SCREW	10	PZ	VM1224A0	65MY 220MM 2 COLOURS SHRINK TUBE	0.200	M												
Code	Description	Qty	UOM																										
VI1081A0	M6X25 STAINLESS STEEL SCREW	10	PZ																										
VM1224A0	65MY 220MM 2 COLOURS SHRINK TUBE	0.200	M																										
EL1195B	Ø8F-Ø8M ELBOW CONNECTION		KEL1195A	Ø8F-Ø8M JG ELBOW FITTING 10 PCS KIT	<table border="1"> <thead> <tr> <th>Code</th> <th>Description</th> <th>Qty</th> <th>UOM</th> </tr> </thead> <tbody> <tr> <td>EL1195A0</td> <td>ELBOW UNION Ø8F-Ø8M</td> <td>10</td> <td>PZ</td> </tr> <tr> <td>VM1224A0</td> <td>65MY 220MM 2 COLOURS SHRINK TUBE</td> <td>0.200</td> <td>M</td> </tr> </tbody> </table>	Code	Description	Qty	UOM	EL1195A0	ELBOW UNION Ø8F-Ø8M	10	PZ	VM1224A0	65MY 220MM 2 COLOURS SHRINK TUBE	0.200	M												
Code	Description	Qty	UOM																										
EL1195A0	ELBOW UNION Ø8F-Ø8M	10	PZ																										
VM1224A0	65MY 220MM 2 COLOURS SHRINK TUBE	0.200	M																										
RC1002A	JG 10M-8F TERMINAL REDUCTION FITTIN		KRC1002A	JG Ø10M-Ø8F REDUCING SPIGOT 10 PCS KIT	<table border="1"> <thead> <tr> <th>Code</th> <th>Description</th> <th>Qty</th> <th>UOM</th> </tr> </thead> <tbody> <tr> <td>RC1002A0</td> <td>JG 10M-8F TERMINAL REDUCTION FITTING</td> <td>10</td> <td>PZ</td> </tr> <tr> <td>VM1224A0</td> <td>65MY 220MM 2 COLOURS SHRINK TUBE</td> <td>0.200</td> <td>M</td> </tr> </tbody> </table>	Code	Description	Qty	UOM	RC1002A0	JG 10M-8F TERMINAL REDUCTION FITTING	10	PZ	VM1224A0	65MY 220MM 2 COLOURS SHRINK TUBE	0.200	M												
Code	Description	Qty	UOM																										
RC1002A0	JG 10M-8F TERMINAL REDUCTION FITTING	10	PZ																										
VM1224A0	65MY 220MM 2 COLOURS SHRINK TUBE	0.200	M																										
VN1165A	230VAC 50/60HZ COOLING DOWN FA		KVN1165A	S.5E ADVANCE/MM 230V COOLING FAN KIT	<table border="1"> <thead> <tr> <th>Code</th> <th>Description</th> <th>Qty</th> <th>UOM</th> </tr> </thead> <tbody> <tr> <td>M0V0017A0</td> <td>HOOD RING GASKET GN1110A2</td> <td>0.100</td> <td>PZ</td> </tr> <tr> <td>VI1099A0</td> <td>SELF-DRILLIN G SCREW 4.8X13 TCB+ Z</td> <td>4</td> <td>PZ</td> </tr> <tr> <td>VM1555A2</td> <td>CT BT COOLING FAN SUPPORT</td> <td>1</td> <td>PZ</td> </tr> <tr> <td>VN1165A0</td> <td>230VAC 50/60HZ COOLING DOWN FAN</td> <td>1</td> <td>PZ</td> </tr> <tr> <td>VN1165A0</td> <td>230VAC 50/60HZ COOLING DOWN FAN</td> <td>1</td> <td>PZ</td> </tr> </tbody> </table>	Code	Description	Qty	UOM	M0V0017A0	HOOD RING GASKET GN1110A2	0.100	PZ	VI1099A0	SELF-DRILLIN G SCREW 4.8X13 TCB+ Z	4	PZ	VM1555A2	CT BT COOLING FAN SUPPORT	1	PZ	VN1165A0	230VAC 50/60HZ COOLING DOWN FAN	1	PZ	VN1165A0	230VAC 50/60HZ COOLING DOWN FAN	1	PZ
Code	Description	Qty	UOM																										
M0V0017A0	HOOD RING GASKET GN1110A2	0.100	PZ																										
VI1099A0	SELF-DRILLIN G SCREW 4.8X13 TCB+ Z	4	PZ																										
VM1555A2	CT BT COOLING FAN SUPPORT	1	PZ																										
VN1165A0	230VAC 50/60HZ COOLING DOWN FAN	1	PZ																										
VN1165A0	230VAC 50/60HZ COOLING DOWN FAN	1	PZ																										



COMPONENT			SPARE PART																																						
Code	Description	Image	Code	Description	Components list																																				
VM1555A	CT BT COOLING FAN SUPPORT		KVN1165A	S.5E ADVANCE/MM 230V COOLING FAN KIT	<table border="1"> <thead> <tr> <th>Code</th> <th>Description</th> <th>Qty</th> <th>UOM</th> </tr> </thead> <tbody> <tr> <td>MOV0017A0</td> <td>HOOD RING</td> <td>0.100</td> <td>PZ</td> </tr> <tr> <td></td> <td>GASKET</td> <td></td> <td></td> </tr> <tr> <td></td> <td>GN1110A2</td> <td></td> <td></td> </tr> <tr> <td>VI1099A0</td> <td>SELF-DRILLIN G SCREW</td> <td>4</td> <td>PZ</td> </tr> <tr> <td></td> <td>4.8X13 TCB+ Z</td> <td></td> <td></td> </tr> <tr> <td>VM1555A2</td> <td>CT BT COOLING FAN SUPPORT</td> <td>1</td> <td>PZ</td> </tr> <tr> <td>VN1165A0</td> <td>230VAC 50/60HZ COOLING DOWN FAN</td> <td>1</td> <td>PZ</td> </tr> <tr> <td>VN1165A0</td> <td>230VAC 50/60HZ COOLING DOWN FAN</td> <td>1</td> <td>PZ</td> </tr> </tbody> </table>	Code	Description	Qty	UOM	MOV0017A0	HOOD RING	0.100	PZ		GASKET				GN1110A2			VI1099A0	SELF-DRILLIN G SCREW	4	PZ		4.8X13 TCB+ Z			VM1555A2	CT BT COOLING FAN SUPPORT	1	PZ	VN1165A0	230VAC 50/60HZ COOLING DOWN FAN	1	PZ	VN1165A0	230VAC 50/60HZ COOLING DOWN FAN	1	PZ
					Code	Description	Qty	UOM																																	
MOV0017A0	HOOD RING	0.100	PZ																																						
	GASKET																																								
	GN1110A2																																								
VI1099A0	SELF-DRILLIN G SCREW	4	PZ																																						
	4.8X13 TCB+ Z																																								
VM1555A2	CT BT COOLING FAN SUPPORT	1	PZ																																						
VN1165A0	230VAC 50/60HZ COOLING DOWN FAN	1	PZ																																						
VN1165A0	230VAC 50/60HZ COOLING DOWN FAN	1	PZ																																						
			KVN1164A	S.5/5E 12VDC COOLING DOWN FAN KIT	<table border="1"> <thead> <tr> <th>Code</th> <th>Description</th> <th>Qty</th> <th>UOM</th> </tr> </thead> <tbody> <tr> <td>VI1099A0</td> <td>SELF-DRILLIN G SCREW</td> <td>4</td> <td>PZ</td> </tr> <tr> <td></td> <td>4.8X13 TCB+ Z</td> <td></td> <td></td> </tr> <tr> <td>VM1555A2</td> <td>CT BT COOLING FAN SUPPORT</td> <td>1</td> <td>PZ</td> </tr> <tr> <td>VN1164A0</td> <td>12VDC COOLING DOWN FAN</td> <td>1</td> <td>PZ</td> </tr> <tr> <td>VN1164A0</td> <td>12VDC COOLING DOWN FAN</td> <td>1</td> <td>PZ</td> </tr> </tbody> </table>	Code	Description	Qty	UOM	VI1099A0	SELF-DRILLIN G SCREW	4	PZ		4.8X13 TCB+ Z			VM1555A2	CT BT COOLING FAN SUPPORT	1	PZ	VN1164A0	12VDC COOLING DOWN FAN	1	PZ	VN1164A0	12VDC COOLING DOWN FAN	1	PZ												
Code	Description	Qty	UOM																																						
VI1099A0	SELF-DRILLIN G SCREW	4	PZ																																						
	4.8X13 TCB+ Z																																								
VM1555A2	CT BT COOLING FAN SUPPORT	1	PZ																																						
VN1164A0	12VDC COOLING DOWN FAN	1	PZ																																						
VN1164A0	12VDC COOLING DOWN FAN	1	PZ																																						
VM1556A	XBC-XVC COOLING FAN GUARD		KVM1556A	XBC-XVC COOLING FAN GUARD KIT	<table border="1"> <thead> <tr> <th>Code</th> <th>Description</th> <th>Qty</th> <th>UOM</th> </tr> </thead> <tbody> <tr> <td>VM1556A0</td> <td>XBC-XVC COOLING FAN GUARD</td> <td>1</td> <td>PZ</td> </tr> </tbody> </table>	Code	Description	Qty	UOM	VM1556A0	XBC-XVC COOLING FAN GUARD	1	PZ																												
Code	Description	Qty	UOM																																						
VM1556A0	XBC-XVC COOLING FAN GUARD	1	PZ																																						
VL1026A	BEND FOR DRAIN PIPE		KVL1026A	DRAIN PIPE BEND KI	<table border="1"> <thead> <tr> <th>Code</th> <th>Description</th> <th>Qty</th> <th>UOM</th> </tr> </thead> <tbody> <tr> <td>GN1400A0</td> <td>U-TRAP SEAL</td> <td>1</td> <td>PZ</td> </tr> <tr> <td>VL1026A0</td> <td>BEND FOR DRAIN PIPE</td> <td>1</td> <td>PZ</td> </tr> <tr> <td>VM1224A0</td> <td>65MY 220MM 2 COLOURS SHRINK TUBE</td> <td>0.300</td> <td>M</td> </tr> <tr> <td>VM2039A0</td> <td>DRAIN BEND FIXING RING</td> <td>1</td> <td>PZ</td> </tr> </tbody> </table>	Code	Description	Qty	UOM	GN1400A0	U-TRAP SEAL	1	PZ	VL1026A0	BEND FOR DRAIN PIPE	1	PZ	VM1224A0	65MY 220MM 2 COLOURS SHRINK TUBE	0.300	M	VM2039A0	DRAIN BEND FIXING RING	1	PZ																
Code	Description	Qty	UOM																																						
GN1400A0	U-TRAP SEAL	1	PZ																																						
VL1026A0	BEND FOR DRAIN PIPE	1	PZ																																						
VM1224A0	65MY 220MM 2 COLOURS SHRINK TUBE	0.300	M																																						
VM2039A0	DRAIN BEND FIXING RING	1	PZ																																						

COMPONENT			SPARE PART																														
Code	Description	Image	Code	Description	Components list																												
VM2039A	DRAIN BEND FIXING RING		KVL1026A	DRAIN PIPE BEND KI	<table border="1"> <thead> <tr> <th>Code</th> <th>Description</th> <th>Qty</th> <th>UOM</th> </tr> </thead> <tbody> <tr> <td>GN1400A0</td> <td>U-TRAP SEAL</td> <td>1</td> <td>PZ</td> </tr> <tr> <td>VL1026A0</td> <td>BEND FOR DRAIN PIPE</td> <td>1</td> <td>PZ</td> </tr> <tr> <td>VM1224A0</td> <td>65MY 220MM 2 COLOURS SHRINK TUBE</td> <td>0.300</td> <td>M</td> </tr> <tr> <td>VM2039A0</td> <td>DRAIN BEND FIXING RING</td> <td>1</td> <td>PZ</td> </tr> </tbody> </table>	Code	Description	Qty	UOM	GN1400A0	U-TRAP SEAL	1	PZ	VL1026A0	BEND FOR DRAIN PIPE	1	PZ	VM1224A0	65MY 220MM 2 COLOURS SHRINK TUBE	0.300	M	VM2039A0	DRAIN BEND FIXING RING	1	PZ								
Code	Description	Qty	UOM																														
GN1400A0	U-TRAP SEAL	1	PZ																														
VL1026A0	BEND FOR DRAIN PIPE	1	PZ																														
VM1224A0	65MY 220MM 2 COLOURS SHRINK TUBE	0.300	M																														
VM2039A0	DRAIN BEND FIXING RING	1	PZ																														
VM1190A	CT BT RIGHT DOOR SPRING LATCH		KVM1190A	CHEFTOP/BAKERTO P DOOR RIGHT LATCH KIT	<table border="1"> <thead> <tr> <th>Code</th> <th>Description</th> <th>Qty</th> <th>UOM</th> </tr> </thead> <tbody> <tr> <td>VI0239A1</td> <td>SELF-TAPPIN G SCREW 4.2X25 TCB+ INOX</td> <td>2</td> <td>PZ</td> </tr> <tr> <td>VI1220A1</td> <td>4.2X12 TCB SELF-TAPPIN G SCREW</td> <td>2</td> <td>PZ</td> </tr> <tr> <td>VM1190A2</td> <td>CT BT RIGHT DOOR SPRING LATCH</td> <td>1</td> <td>PZ</td> </tr> <tr> <td>VM1192A1</td> <td>CT BT DOOR SPRING LATCH BACK COVER</td> <td>1</td> <td>PZ</td> </tr> <tr> <td>VM1224A0</td> <td>65MY 220MM 2 COLOURS SHRINK TUBE</td> <td>0.200</td> <td>M</td> </tr> <tr> <td>VM1460A0</td> <td>XBC/XVC RIGHT DOOR LATCH CAP</td> <td>1</td> <td>PZ</td> </tr> </tbody> </table>	Code	Description	Qty	UOM	VI0239A1	SELF-TAPPIN G SCREW 4.2X25 TCB+ INOX	2	PZ	VI1220A1	4.2X12 TCB SELF-TAPPIN G SCREW	2	PZ	VM1190A2	CT BT RIGHT DOOR SPRING LATCH	1	PZ	VM1192A1	CT BT DOOR SPRING LATCH BACK COVER	1	PZ	VM1224A0	65MY 220MM 2 COLOURS SHRINK TUBE	0.200	M	VM1460A0	XBC/XVC RIGHT DOOR LATCH CAP	1	PZ
Code	Description	Qty	UOM																														
VI0239A1	SELF-TAPPIN G SCREW 4.2X25 TCB+ INOX	2	PZ																														
VI1220A1	4.2X12 TCB SELF-TAPPIN G SCREW	2	PZ																														
VM1190A2	CT BT RIGHT DOOR SPRING LATCH	1	PZ																														
VM1192A1	CT BT DOOR SPRING LATCH BACK COVER	1	PZ																														
VM1224A0	65MY 220MM 2 COLOURS SHRINK TUBE	0.200	M																														
VM1460A0	XBC/XVC RIGHT DOOR LATCH CAP	1	PZ																														
VM1240A	NYLON SUPPORT CAP		KVM1240A	4 PCS COUNTER BRACKET SUPPORT CAP KIT	<table border="1"> <thead> <tr> <th>Code</th> <th>Description</th> <th>Qty</th> <th>UOM</th> </tr> </thead> <tbody> <tr> <td>VM1224A0</td> <td>65MY 220MM 2 COLOURS SHRINK TUBE</td> <td>0.200</td> <td>M</td> </tr> <tr> <td>VM1240A0</td> <td>NYLON SUPPORT CAP</td> <td>4</td> <td>PZ</td> </tr> </tbody> </table>	Code	Description	Qty	UOM	VM1224A0	65MY 220MM 2 COLOURS SHRINK TUBE	0.200	M	VM1240A0	NYLON SUPPORT CAP	4	PZ																
Code	Description	Qty	UOM																														
VM1224A0	65MY 220MM 2 COLOURS SHRINK TUBE	0.200	M																														
VM1240A0	NYLON SUPPORT CAP	4	PZ																														
VM1195A	HOLES BLANKING PLATE XVC204/304/504/704		VM1195A0	HOLES BLANKING PLATE XVC204/304/504/704																													













COMPONENT			SPARE PART																														
Code	Description	Image	Code	Description	Components list																												
VM1192A	CT BT DOOR SPRING LATCH BACK COVER		KVM1190A	CHEFTOP/BAKERTO P DOOR RIGHT LATCH KIT	<table border="1"> <thead> <tr> <th>Code</th> <th>Description</th> <th>Qty</th> <th>UOM</th> </tr> </thead> <tbody> <tr> <td>VM1192A1</td> <td>CT BT DOOR SPRING LATCH BACK COVER</td> <td>1</td> <td>PZ</td> </tr> <tr> <td>VM1224A0</td> <td>65MY 220MM 2 COLOURS SHRINK TUBE</td> <td>0.200</td> <td>M</td> </tr> <tr> <td>VM1460A0</td> <td>XBC/XVC RIGHT DOOR LATCH CAP</td> <td>1</td> <td>PZ</td> </tr> </tbody> </table>	Code	Description	Qty	UOM	VM1192A1	CT BT DOOR SPRING LATCH BACK COVER	1	PZ	VM1224A0	65MY 220MM 2 COLOURS SHRINK TUBE	0.200	M	VM1460A0	XBC/XVC RIGHT DOOR LATCH CAP	1	PZ												
					Code	Description	Qty	UOM																									
					VM1192A1	CT BT DOOR SPRING LATCH BACK COVER	1	PZ																									
VM1224A0	65MY 220MM 2 COLOURS SHRINK TUBE	0.200	M																														
VM1460A0	XBC/XVC RIGHT DOOR LATCH CAP	1	PZ																														
<table border="1"> <thead> <tr> <th>Code</th> <th>Description</th> <th>Qty</th> <th>UOM</th> </tr> </thead> <tbody> <tr> <td>VI0239A1</td> <td>SELF-TAPPIN G SCREW 4.2X25 TCB+ INOX</td> <td>2</td> <td>PZ</td> </tr> <tr> <td>VI1220A1</td> <td>4.2X12 TCB SELF-TAPPIN G SCREW</td> <td>2</td> <td>PZ</td> </tr> <tr> <td>VM1191A2</td> <td>CT BT LEFT DOOR SPRING LATCH</td> <td>1</td> <td>PZ</td> </tr> <tr> <td>VM1192A1</td> <td>CT BT DOOR SPRING LATCH BACK COVER</td> <td>1</td> <td>PZ</td> </tr> <tr> <td>VM1224A0</td> <td>65MY 220MM 2 COLOURS SHRINK TUBE</td> <td>0.200</td> <td>M</td> </tr> <tr> <td>VM1460A0</td> <td>XBC/XVC RIGHT DOOR LATCH CAP</td> <td>1</td> <td>PZ</td> </tr> </tbody> </table>	Code	Description	Qty	UOM	VI0239A1	SELF-TAPPIN G SCREW 4.2X25 TCB+ INOX	2	PZ	VI1220A1	4.2X12 TCB SELF-TAPPIN G SCREW	2	PZ	VM1191A2	CT BT LEFT DOOR SPRING LATCH	1	PZ	VM1192A1	CT BT DOOR SPRING LATCH BACK COVER	1	PZ	VM1224A0	65MY 220MM 2 COLOURS SHRINK TUBE	0.200	M	VM1460A0	XBC/XVC RIGHT DOOR LATCH CAP	1	PZ					
Code	Description	Qty	UOM																														
VI0239A1	SELF-TAPPIN G SCREW 4.2X25 TCB+ INOX	2	PZ																														
VI1220A1	4.2X12 TCB SELF-TAPPIN G SCREW	2	PZ																														
VM1191A2	CT BT LEFT DOOR SPRING LATCH	1	PZ																														
VM1192A1	CT BT DOOR SPRING LATCH BACK COVER	1	PZ																														
VM1224A0	65MY 220MM 2 COLOURS SHRINK TUBE	0.200	M																														
VM1460A0	XBC/XVC RIGHT DOOR LATCH CAP	1	PZ																														
<table border="1"> <thead> <tr> <th>Code</th> <th>Description</th> <th>Qty</th> <th>UOM</th> </tr> </thead> <tbody> <tr> <td>VM1165B0</td> <td>CT BT DOOR UPPER BRACKET</td> <td>1</td> <td>PZ</td> </tr> <tr> <td>VM1224A0</td> <td>65MY 220MM 2 COLOURS SHRINK TUBE</td> <td>0.250</td> <td>M</td> </tr> </tbody> </table>	Code	Description	Qty	UOM	VM1165B0	CT BT DOOR UPPER BRACKET	1	PZ	VM1224A0	65MY 220MM 2 COLOURS SHRINK TUBE	0.250	M																					
Code	Description	Qty	UOM																														
VM1165B0	CT BT DOOR UPPER BRACKET	1	PZ																														
VM1224A0	65MY 220MM 2 COLOURS SHRINK TUBE	0.250	M																														
VM1191A	CT BT LEFT DOOR SPRING LATCH		KVM1191A	CHEFTOP/BAKERTO P DOOR LEFT LATCH KIT	<table border="1"> <thead> <tr> <th>Code</th> <th>Description</th> <th>Qty</th> <th>UOM</th> </tr> </thead> <tbody> <tr> <td>VI0239A1</td> <td>SELF-TAPPIN G SCREW 4.2X25 TCB+ INOX</td> <td>2</td> <td>PZ</td> </tr> <tr> <td>VI1220A1</td> <td>4.2X12 TCB SELF-TAPPIN G SCREW</td> <td>2</td> <td>PZ</td> </tr> <tr> <td>VM1191A2</td> <td>CT BT LEFT DOOR SPRING LATCH</td> <td>1</td> <td>PZ</td> </tr> <tr> <td>VM1192A1</td> <td>CT BT DOOR SPRING LATCH BACK COVER</td> <td>1</td> <td>PZ</td> </tr> <tr> <td>VM1224A0</td> <td>65MY 220MM 2 COLOURS SHRINK TUBE</td> <td>0.200</td> <td>M</td> </tr> <tr> <td>VM1460A0</td> <td>XBC/XVC RIGHT DOOR LATCH CAP</td> <td>1</td> <td>PZ</td> </tr> </tbody> </table>	Code	Description	Qty	UOM	VI0239A1	SELF-TAPPIN G SCREW 4.2X25 TCB+ INOX	2	PZ	VI1220A1	4.2X12 TCB SELF-TAPPIN G SCREW	2	PZ	VM1191A2	CT BT LEFT DOOR SPRING LATCH	1	PZ	VM1192A1	CT BT DOOR SPRING LATCH BACK COVER	1	PZ	VM1224A0	65MY 220MM 2 COLOURS SHRINK TUBE	0.200	M	VM1460A0	XBC/XVC RIGHT DOOR LATCH CAP	1	PZ
Code	Description	Qty	UOM																														
VI0239A1	SELF-TAPPIN G SCREW 4.2X25 TCB+ INOX	2	PZ																														
VI1220A1	4.2X12 TCB SELF-TAPPIN G SCREW	2	PZ																														
VM1191A2	CT BT LEFT DOOR SPRING LATCH	1	PZ																														
VM1192A1	CT BT DOOR SPRING LATCH BACK COVER	1	PZ																														
VM1224A0	65MY 220MM 2 COLOURS SHRINK TUBE	0.200	M																														
VM1460A0	XBC/XVC RIGHT DOOR LATCH CAP	1	PZ																														
VM1165B	CT BT DOOR UPPER BRACKET		KVM1165B	CT BT CL BL DOOR UPPER BRACKET KI	<table border="1"> <thead> <tr> <th>Code</th> <th>Description</th> <th>Qty</th> <th>UOM</th> </tr> </thead> <tbody> <tr> <td>VM1165B0</td> <td>CT BT DOOR UPPER BRACKET</td> <td>1</td> <td>PZ</td> </tr> <tr> <td>VM1224A0</td> <td>65MY 220MM 2 COLOURS SHRINK TUBE</td> <td>0.250</td> <td>M</td> </tr> </tbody> </table>	Code	Description	Qty	UOM	VM1165B0	CT BT DOOR UPPER BRACKET	1	PZ	VM1224A0	65MY 220MM 2 COLOURS SHRINK TUBE	0.250	M																
Code	Description	Qty	UOM																														
VM1165B0	CT BT DOOR UPPER BRACKET	1	PZ																														
VM1224A0	65MY 220MM 2 COLOURS SHRINK TUBE	0.250	M																														
VM1166A	CAP FOR DOOR UPPER STIRRUP XVC204/304/5		KVM1166A	DOOR UPPER BRACKET COVER KI	<table border="1"> <thead> <tr> <th>Code</th> <th>Description</th> <th>Qty</th> <th>UOM</th> </tr> </thead> <tbody> <tr> <td>VM1166A0</td> <td>CAP FOR DOOR UPPER STIRRUP XVC204/304/5</td> <td>1</td> <td>PZ</td> </tr> <tr> <td>VM1224A0</td> <td>65MY 220MM 2 COLOURS SHRINK TUBE</td> <td>0.200</td> <td>M</td> </tr> </tbody> </table>	Code	Description	Qty	UOM	VM1166A0	CAP FOR DOOR UPPER STIRRUP XVC204/304/5	1	PZ	VM1224A0	65MY 220MM 2 COLOURS SHRINK TUBE	0.200	M																
Code	Description	Qty	UOM																														
VM1166A0	CAP FOR DOOR UPPER STIRRUP XVC204/304/5	1	PZ																														
VM1224A0	65MY 220MM 2 COLOURS SHRINK TUBE	0.200	M																														

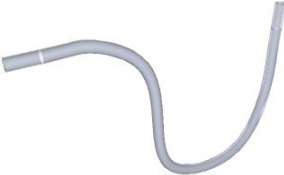
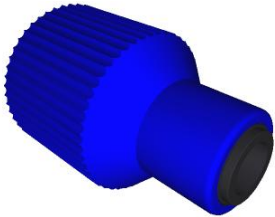





COMPONENT			SPARE PART																		
Code	Description	Image	Code	Description	Components list																
VE1295A	MK 16A 230V DOOR MICROSWITCH		KVE1295A	16A 230V DOOR MICROSWITCH KIT	<table border="1"> <thead> <tr> <th>Code</th> <th>Description</th> <th>Qty</th> <th>UOM</th> </tr> </thead> <tbody> <tr> <td>VE1295A0</td> <td>MK 16A 230V DOOR MICROSWITC</td> <td>1</td> <td>PZ</td> </tr> <tr> <td>VM1224A0</td> <td>65MY 220MM 2 COLOURS SHRINK TUBE</td> <td>0.300</td> <td>M</td> </tr> </tbody> </table>	Code	Description	Qty	UOM	VE1295A0	MK 16A 230V DOOR MICROSWITC	1	PZ	VM1224A0	65MY 220MM 2 COLOURS SHRINK TUBE	0.300	M				
Code	Description	Qty	UOM																		
VE1295A0	MK 16A 230V DOOR MICROSWITC	1	PZ																		
VM1224A0	65MY 220MM 2 COLOURS SHRINK TUBE	0.300	M																		
VM1200A	DOOR MECHANIC MICROSWITCH SUPPORT PLATE		VM1200A0	DOOR MECHANIC MICROSWITCH SUPPORT PLATE																	
0E1331B	CHEFLUX-BAKERLU X EXTERNAL BOTTOM PANEL		0E1331B0	CHEFLUX-BAKERLU X EXTERNAL BOTTOM PANEL																	
0H2560A	XBC/XVC ZINC PLAT. DOOR COUNTERBRACKET		0H2560A0	XBC/XVC ZINC PLAT. DOOR COUNTERBRACKET																	
VM1460A	XBC/XVC RIGHT DOOR LATCH CAP		KVM1460A	XBC/XVC RIGHT DOOR LATCH CAP KIT	<table border="1"> <thead> <tr> <th>Code</th> <th>Description</th> <th>Qty</th> <th>UOM</th> </tr> </thead> <tbody> <tr> <td>VI0239A1</td> <td>SELF-TAPPIN G SCREW 4.2X25 TCB+ INOX</td> <td>2</td> <td>PZ</td> </tr> <tr> <td>VM1224A0</td> <td>65MY 220MM 2 COLOURS SHRINK TUBE</td> <td>0.200</td> <td>M</td> </tr> <tr> <td>VM1460A0</td> <td>XBC/XVC RIGHT DOOR LATCH CAP</td> <td>1</td> <td>PZ</td> </tr> </tbody> </table>	Code	Description	Qty	UOM	VI0239A1	SELF-TAPPIN G SCREW 4.2X25 TCB+ INOX	2	PZ	VM1224A0	65MY 220MM 2 COLOURS SHRINK TUBE	0.200	M	VM1460A0	XBC/XVC RIGHT DOOR LATCH CAP	1	PZ
Code	Description	Qty	UOM																		
VI0239A1	SELF-TAPPIN G SCREW 4.2X25 TCB+ INOX	2	PZ																		
VM1224A0	65MY 220MM 2 COLOURS SHRINK TUBE	0.200	M																		
VM1460A0	XBC/XVC RIGHT DOOR LATCH CAP	1	PZ																		



COMPONENT			SPARE PART																						
Code	Description	Image	Code	Description	Components list																				
VM1461A	XBC/XVC LEFT DOOR LATCH COVE		VM1461A0	XBC/XVC LEFT DOOR LATCH COVE																					
0H6240A	BAKERLUX CHEFLUX ST. STEEL CONTROL PANEL		0H6240A0	BAKERLUX CHEFLUX ST. STEEL CONTROL PANEL																					
0H6333A	BL CL THREADED DOOR COUNTER BRACKET		0H6333A0	BL CL THREADED DOOR COUNTER BRACKET																					
TB2808A	TB1815A0-D8 H2O SOLENOID LUX 0,5M		TB2808A0	TB1815A0-D8 H2O SOLENOID LUX 0,5M																					
RC1365A	3/4"-10 JG FEMALE CONNECTION		KRC1365A	3/4"-10 OR 8 JG WATER CONNECTION KIT	<table border="1"> <thead> <tr> <th>Code</th> <th>Description</th> <th>Qty</th> <th>UOM</th> </tr> </thead> <tbody> <tr> <td>GN1200A1</td> <td>3/4 CONNECTION SEAL D=24 RUBBER+NET</td> <td>1</td> <td>PZ</td> </tr> <tr> <td>RC1002A0</td> <td>JG 10M-8F TERMINAL REDUCTION FITTING</td> <td>1</td> <td>PZ</td> </tr> <tr> <td>RC1365A0</td> <td>3/4"-10 JG FEMALE CONNECTION</td> <td>1</td> <td>PZ</td> </tr> <tr> <td>VM1224A0</td> <td>65MY 220MM 2 COLOURS SHRINK TUBE</td> <td>0.150</td> <td>M</td> </tr> </tbody> </table>	Code	Description	Qty	UOM	GN1200A1	3/4 CONNECTION SEAL D=24 RUBBER+NET	1	PZ	RC1002A0	JG 10M-8F TERMINAL REDUCTION FITTING	1	PZ	RC1365A0	3/4"-10 JG FEMALE CONNECTION	1	PZ	VM1224A0	65MY 220MM 2 COLOURS SHRINK TUBE	0.150	M
Code	Description	Qty	UOM																						
GN1200A1	3/4 CONNECTION SEAL D=24 RUBBER+NET	1	PZ																						
RC1002A0	JG 10M-8F TERMINAL REDUCTION FITTING	1	PZ																						
RC1365A0	3/4"-10 JG FEMALE CONNECTION	1	PZ																						
VM1224A0	65MY 220MM 2 COLOURS SHRINK TUBE	0.150	M																						

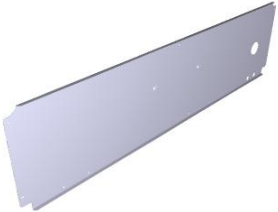

COMPONENT			SPARE PART										
Code	Description	Image	Code	Description	Components list								
VL1034C	MESH WATER FILTER D10		KVL1135A	3/4-JG10 FITTING WITH FILTER AND VNR KIT	<table border="1"> <thead> <tr> <th>Code</th> <th>Description</th> <th>Qty</th> <th>UOM</th> </tr> </thead> <tbody> <tr> <td>VL1135A0</td> <td>3/4-JG10 CONNECTOR + FILTER AND NRV</td> <td>1</td> <td>PZ</td> </tr> </tbody> </table>	Code	Description	Qty	UOM	VL1135A0	3/4-JG10 CONNECTOR + FILTER AND NRV	1	PZ
					Code	Description	Qty	UOM					
VL1135A0	3/4-JG10 CONNECTOR + FILTER AND NRV	1	PZ										
<table border="1"> <tbody> <tr> <td>VM1224A0</td> <td>65MY 220MM 2 COLOURS SHRINK TUBE</td> <td>0.150</td> <td>M</td> </tr> </tbody> </table>	VM1224A0	65MY 220MM 2 COLOURS SHRINK TUBE	0.150	M									
VM1224A0	65MY 220MM 2 COLOURS SHRINK TUBE	0.150	M										
TB2237A	Ø10 WATER MAIN CONNECTION PIPE		KTB2599A	Ø10 PET WATER PIPE TB2243A0 100M KIT	<table border="1"> <thead> <tr> <th>Code</th> <th>Description</th> <th>Qty</th> <th>UOM</th> </tr> </thead> <tbody> <tr> <td>TB2243A0</td> <td>D10 PE TRANSPAREN T PIPE</td> <td>100</td> <td>M</td> </tr> </tbody> </table>	Code	Description	Qty	UOM	TB2243A0	D10 PE TRANSPAREN T PIPE	100	M
					Code	Description	Qty	UOM					
TB2243A0	D10 PE TRANSPAREN T PIPE	100	M										
<table border="1"> <tbody> <tr> <td>VM1059A1</td> <td>HEAT SHRINK FILM H800</td> <td>1.500</td> <td>M</td> </tr> </tbody> </table>	VM1059A1	HEAT SHRINK FILM H800	1.500	M									
VM1059A1	HEAT SHRINK FILM H800	1.500	M										
RC1360A	10 - 10 JG ELBOW FITTING		KRC1360A	Ø10 - Ø10 JG ELBOW FITTING 10 PCS KIT	<table border="1"> <thead> <tr> <th>Code</th> <th>Description</th> <th>Qty</th> <th>UOM</th> </tr> </thead> <tbody> <tr> <td>RC1360A0</td> <td>10 - 10 JG ELBOW FITTING</td> <td>10</td> <td>PZ</td> </tr> </tbody> </table>	Code	Description	Qty	UOM	RC1360A0	10 - 10 JG ELBOW FITTING	10	PZ
					Code	Description	Qty	UOM					
RC1360A0	10 - 10 JG ELBOW FITTING	10	PZ										
<table border="1"> <tbody> <tr> <td>VM1224A0</td> <td>65MY 220MM 2 COLOURS SHRINK TUBE</td> <td>0.250</td> <td>M</td> </tr> </tbody> </table>	VM1224A0	65MY 220MM 2 COLOURS SHRINK TUBE	0.250	M									
VM1224A0	65MY 220MM 2 COLOURS SHRINK TUBE	0.250	M										
EL1349A	CLIP TO FIX Ø10 MM CONNECTION JOIN		KEL1349A	Ø10 FITTING LOCKING CLIPS 10 PCS KIT	<table border="1"> <thead> <tr> <th>Code</th> <th>Description</th> <th>Qty</th> <th>UOM</th> </tr> </thead> <tbody> <tr> <td>EL1349A0</td> <td>CLIP TO FIX Ø10 MM CONNECTION JOINT</td> <td>10</td> <td>PZ</td> </tr> </tbody> </table>	Code	Description	Qty	UOM	EL1349A0	CLIP TO FIX Ø10 MM CONNECTION JOINT	10	PZ
					Code	Description	Qty	UOM					
EL1349A0	CLIP TO FIX Ø10 MM CONNECTION JOINT	10	PZ										
<table border="1"> <tbody> <tr> <td>VM1224A0</td> <td>65MY 220MM 2 COLOURS SHRINK TUBE</td> <td>0.200</td> <td>M</td> </tr> </tbody> </table>	VM1224A0	65MY 220MM 2 COLOURS SHRINK TUBE	0.200	M									
VM1224A0	65MY 220MM 2 COLOURS SHRINK TUBE	0.200	M										
0D2210A	LEFT SIDE PANEL BL CL 89-		0D2210A0	LEFT SIDE PANEL BL CL 89-									

COMPONENT			SPARE PART																						
Code	Description	Image	Code	Description	Components list																				
0D2211A	XB893 XV893 MANUAL EXTERNAL RIGHT PANEL		0D2211A0	XB893 XV893 MANUAL EXTERNAL RIGHT PANEL																					
PD1066B	BI-COMPONENT FOOT H100 (E SERIES FOOT)		KPD1066B	E SERIES OVEN H100 FOOT KIT	<table border="1"> <thead> <tr> <th>Code</th> <th>Description</th> <th>Qty</th> <th>UOM</th> </tr> </thead> <tbody> <tr> <td>PD1063A0</td> <td>CT BT FOOT STOP BRACKE</td> <td>1</td> <td>PZ</td> </tr> <tr> <td>PD1066B0</td> <td>BI-COMPONE NT FOOT H100 (E SERIES FOOT)</td> <td>1</td> <td>PZ</td> </tr> <tr> <td>VI1220A1</td> <td>4,2X12 TCB SELF-TAPPIN G SCREW</td> <td>5</td> <td>PZ</td> </tr> <tr> <td>VM1224A0</td> <td>65MY 220MM 2 COLOURS SHRINK TUBE</td> <td>0.300</td> <td>M</td> </tr> </tbody> </table>	Code	Description	Qty	UOM	PD1063A0	CT BT FOOT STOP BRACKE	1	PZ	PD1066B0	BI-COMPONE NT FOOT H100 (E SERIES FOOT)	1	PZ	VI1220A1	4,2X12 TCB SELF-TAPPIN G SCREW	5	PZ	VM1224A0	65MY 220MM 2 COLOURS SHRINK TUBE	0.300	M
Code	Description	Qty	UOM																						
PD1063A0	CT BT FOOT STOP BRACKE	1	PZ																						
PD1066B0	BI-COMPONE NT FOOT H100 (E SERIES FOOT)	1	PZ																						
VI1220A1	4,2X12 TCB SELF-TAPPIN G SCREW	5	PZ																						
VM1224A0	65MY 220MM 2 COLOURS SHRINK TUBE	0.300	M																						
PD1063A	CT BT FOOT STOP BRACKET		KPD1063A	OVEN FOOT STOPPING BRACKET KIT	<table border="1"> <thead> <tr> <th>Code</th> <th>Description</th> <th>Qty</th> <th>UOM</th> </tr> </thead> <tbody> <tr> <td>PD1063A0</td> <td>CT BT FOOT STOP BRACKE</td> <td>4</td> <td>PZ</td> </tr> <tr> <td>VI1950A0</td> <td>ST. STEEL 4,2X13 TCB SELF-DRILLIN G SCREW</td> <td>8</td> <td>PZ</td> </tr> <tr> <td>VM1224A0</td> <td>65MY 220MM 2 COLOURS SHRINK TUBE</td> <td>0.300</td> <td>M</td> </tr> </tbody> </table>	Code	Description	Qty	UOM	PD1063A0	CT BT FOOT STOP BRACKE	4	PZ	VI1950A0	ST. STEEL 4,2X13 TCB SELF-DRILLIN G SCREW	8	PZ	VM1224A0	65MY 220MM 2 COLOURS SHRINK TUBE	0.300	M				
Code	Description	Qty	UOM																						
PD1063A0	CT BT FOOT STOP BRACKE	4	PZ																						
VI1950A0	ST. STEEL 4,2X13 TCB SELF-DRILLIN G SCREW	8	PZ																						
VM1224A0	65MY 220MM 2 COLOURS SHRINK TUBE	0.300	M																						
0D2209B	CHEF-BAKERLUX GAS EXTERNAL UPPER COVER		0D2209B0	CHEF-BAKERLUX GAS EXTERNAL UPPER COVER																					
0H6569A	CHEF-BAKERLUX GAS EXTERNAL BACK COVER		0H6569A0	CHEF-BAKERLUX GAS EXTERNAL BACK COVER																					



COMPONENT			SPARE PART																						
Code	Description	Image	Code	Description	Components list																				
VM1762A	INNER LAMP SUPPORT		KVM1762A	LAMP INTERNAL SUPPORT KIT	<table border="1"> <thead> <tr> <th>Code</th> <th>Description</th> <th>Qty</th> <th>UOM</th> </tr> </thead> <tbody> <tr> <td>VM1224A0</td> <td>65MY 220MM 2 COLOURS SHRINK TUBE</td> <td>0.150</td> <td>M</td> </tr> <tr> <td>VM1762A0</td> <td>INNER LAMP SUPPORT</td> <td>1</td> <td>PZ</td> </tr> </tbody> </table>	Code	Description	Qty	UOM	VM1224A0	65MY 220MM 2 COLOURS SHRINK TUBE	0.150	M	VM1762A0	INNER LAMP SUPPORT	1	PZ								
Code	Description	Qty	UOM																						
VM1224A0	65MY 220MM 2 COLOURS SHRINK TUBE	0.150	M																						
VM1762A0	INNER LAMP SUPPORT	1	PZ																						
VE1530A	GOLD THERMOMETER BLUE LIGHT COVER		KVE1530A	GOLDEN THERMOMETER BLUE LIGHT KIT	<table border="1"> <thead> <tr> <th>Code</th> <th>Description</th> <th>Qty</th> <th>UOM</th> </tr> </thead> <tbody> <tr> <td>VE1530A0</td> <td>GOLD THERMOMETE R BLUE LIGHT COVER</td> <td>1</td> <td>PZ</td> </tr> <tr> <td>VM1224A0</td> <td>65MY 220MM 2 COLOURS SHRINK TUBE</td> <td>0.150</td> <td>M</td> </tr> <tr> <td>VM1762A0</td> <td>INNER LAMP SUPPORT</td> <td>1</td> <td>PZ</td> </tr> <tr> <td>VM2009A0</td> <td>ELLIPTICAL SILVER SUPPORT D16</td> <td>1</td> <td>PZ</td> </tr> </tbody> </table>	Code	Description	Qty	UOM	VE1530A0	GOLD THERMOMETE R BLUE LIGHT COVER	1	PZ	VM1224A0	65MY 220MM 2 COLOURS SHRINK TUBE	0.150	M	VM1762A0	INNER LAMP SUPPORT	1	PZ	VM2009A0	ELLIPTICAL SILVER SUPPORT D16	1	PZ
Code	Description	Qty	UOM																						
VE1530A0	GOLD THERMOMETE R BLUE LIGHT COVER	1	PZ																						
VM1224A0	65MY 220MM 2 COLOURS SHRINK TUBE	0.150	M																						
VM1762A0	INNER LAMP SUPPORT	1	PZ																						
VM2009A0	ELLIPTICAL SILVER SUPPORT D16	1	PZ																						
TM1005A	M12 60 MIN 250V 16A TIMER		KTM1005A	60 MIN TIMER KIT	<table border="1"> <thead> <tr> <th>Code</th> <th>Description</th> <th>Qty</th> <th>UOM</th> </tr> </thead> <tbody> <tr> <td>TM1005A0</td> <td>M12 60 MIN 250V 16A TIME</td> <td>1</td> <td>PZ</td> </tr> <tr> <td>V11850A0</td> <td>M4X6 NICKEL PLATED FIXING SCRE</td> <td>2</td> <td>PZ</td> </tr> <tr> <td>VM1224A0</td> <td>65MY 220MM 2 COLOURS SHRINK TUBE</td> <td>0.250</td> <td>M</td> </tr> </tbody> </table>	Code	Description	Qty	UOM	TM1005A0	M12 60 MIN 250V 16A TIME	1	PZ	V11850A0	M4X6 NICKEL PLATED FIXING SCRE	2	PZ	VM1224A0	65MY 220MM 2 COLOURS SHRINK TUBE	0.250	M				
Code	Description	Qty	UOM																						
TM1005A0	M12 60 MIN 250V 16A TIME	1	PZ																						
V11850A0	M4X6 NICKEL PLATED FIXING SCRE	2	PZ																						
VM1224A0	65MY 220MM 2 COLOURS SHRINK TUBE	0.250	M																						
TR1100A	269°C 55.19052.80 ADJUSTABLE THERMOSTAT		KTR1100A	269°C THERMOSTAT KIT	<table border="1"> <thead> <tr> <th>Code</th> <th>Description</th> <th>Qty</th> <th>UOM</th> </tr> </thead> <tbody> <tr> <td>TR1100A0</td> <td>269°C 55.19052.80 ADJUSTABLE THERMOSTAT</td> <td>1</td> <td>PZ</td> </tr> <tr> <td>V11850A0</td> <td>M4X6 NICKEL PLATED FIXING SCRE</td> <td>2</td> <td>PZ</td> </tr> </tbody> </table>	Code	Description	Qty	UOM	TR1100A0	269°C 55.19052.80 ADJUSTABLE THERMOSTAT	1	PZ	V11850A0	M4X6 NICKEL PLATED FIXING SCRE	2	PZ								
Code	Description	Qty	UOM																						
TR1100A0	269°C 55.19052.80 ADJUSTABLE THERMOSTAT	1	PZ																						
V11850A0	M4X6 NICKEL PLATED FIXING SCRE	2	PZ																						
TM1001C	15 SEC 120V ELECTRONIC BUZZE		KTM1001C	15 SEC BUZZER KIT	<table border="1"> <thead> <tr> <th>Code</th> <th>Description</th> <th>Qty</th> <th>UOM</th> </tr> </thead> <tbody> <tr> <td>TM1001C2</td> <td>15 SEC 120V ELECTRONIC BUZZER</td> <td>1</td> <td>PZ</td> </tr> <tr> <td>TM1001C3</td> <td>15 SEC 120/240V BUZZER KIT</td> <td>1</td> <td>PZ</td> </tr> <tr> <td>V11220A1</td> <td>4,2X12 TCB SELF-TAPPIN G SCREW</td> <td>3</td> <td>PZ</td> </tr> </tbody> </table>	Code	Description	Qty	UOM	TM1001C2	15 SEC 120V ELECTRONIC BUZZER	1	PZ	TM1001C3	15 SEC 120/240V BUZZER KIT	1	PZ	V11220A1	4,2X12 TCB SELF-TAPPIN G SCREW	3	PZ				
Code	Description	Qty	UOM																						
TM1001C2	15 SEC 120V ELECTRONIC BUZZER	1	PZ																						
TM1001C3	15 SEC 120/240V BUZZER KIT	1	PZ																						
V11220A1	4,2X12 TCB SELF-TAPPIN G SCREW	3	PZ																						



COMPONENT			SPARE PART																														
Code	Description	Image	Code	Description	Components list																												
TM1001C	15 SEC 120V ELECTRONIC BUZZE		KTM1001C	15 SEC BUZZER KIT	<table border="1"> <thead> <tr> <th>Code</th> <th>Description</th> <th>Qty</th> <th>UOM</th> </tr> </thead> <tbody> <tr> <td>VI1850A0</td> <td>M4X6 NICKEL PLATED FIXING SCRE</td> <td>3</td> <td>PZ</td> </tr> <tr> <td>VM1745A0</td> <td>CARD SUPPORT</td> <td>3</td> <td>PZ</td> </tr> <tr> <td>VM2147A0</td> <td>410X343X15 MM PINK SMOOTH ESD SPONGE</td> <td>1</td> <td>PZ</td> </tr> </tbody> </table>	Code	Description	Qty	UOM	VI1850A0	M4X6 NICKEL PLATED FIXING SCRE	3	PZ	VM1745A0	CARD SUPPORT	3	PZ	VM2147A0	410X343X15 MM PINK SMOOTH ESD SPONGE	1	PZ												
Code	Description	Qty	UOM																														
VI1850A0	M4X6 NICKEL PLATED FIXING SCRE	3	PZ																														
VM1745A0	CARD SUPPORT	3	PZ																														
VM2147A0	410X343X15 MM PINK SMOOTH ESD SPONGE	1	PZ																														
VE1535A	230V WHITE LED		KVE1535A	LED LIGHT 1 PC KIT	<table border="1"> <thead> <tr> <th>Code</th> <th>Description</th> <th>Qty</th> <th>UOM</th> </tr> </thead> <tbody> <tr> <td>VE1535A1</td> <td>230V WHITE LED</td> <td>1</td> <td>PZ</td> </tr> <tr> <td>VM1224A0</td> <td>65MY 220MM 2 COLOURS SHRINK TUBE</td> <td>0.200</td> <td>M</td> </tr> </tbody> </table>	Code	Description	Qty	UOM	VE1535A1	230V WHITE LED	1	PZ	VM1224A0	65MY 220MM 2 COLOURS SHRINK TUBE	0.200	M																
Code	Description	Qty	UOM																														
VE1535A1	230V WHITE LED	1	PZ																														
VM1224A0	65MY 220MM 2 COLOURS SHRINK TUBE	0.200	M																														
			KVE0105A	CLOUD LED LIGHT+COVER+SUP PORT KIT	<table border="1"> <thead> <tr> <th>Code</th> <th>Description</th> <th>Qty</th> <th>UOM</th> </tr> </thead> <tbody> <tr> <td>VE1170A0</td> <td>D16 OPAQUE NICKEL ELLIPTICAL SUPPORT</td> <td>1</td> <td>PZ</td> </tr> <tr> <td>VE1535A1</td> <td>230V WHITE LED</td> <td>1</td> <td>PZ</td> </tr> <tr> <td>VM1761A0</td> <td>D16 BLACK ELLIPTICAL SUPPORT</td> <td>1</td> <td>PZ</td> </tr> <tr> <td>VM1782A0</td> <td>INNER LAMP SUPPORT</td> <td>1</td> <td>PZ</td> </tr> <tr> <td>VM1903A0</td> <td>GREEN PILOT WITH GOLD "CLOUD"</td> <td>1</td> <td>PZ</td> </tr> </tbody> </table>	Code	Description	Qty	UOM	VE1170A0	D16 OPAQUE NICKEL ELLIPTICAL SUPPORT	1	PZ	VE1535A1	230V WHITE LED	1	PZ	VM1761A0	D16 BLACK ELLIPTICAL SUPPORT	1	PZ	VM1782A0	INNER LAMP SUPPORT	1	PZ	VM1903A0	GREEN PILOT WITH GOLD "CLOUD"	1	PZ				
Code	Description	Qty	UOM																														
VE1170A0	D16 OPAQUE NICKEL ELLIPTICAL SUPPORT	1	PZ																														
VE1535A1	230V WHITE LED	1	PZ																														
VM1761A0	D16 BLACK ELLIPTICAL SUPPORT	1	PZ																														
VM1782A0	INNER LAMP SUPPORT	1	PZ																														
VM1903A0	GREEN PILOT WITH GOLD "CLOUD"	1	PZ																														
			KVE0104A	NEUTRAL GREEN LIGHT KIT	<table border="1"> <thead> <tr> <th>Code</th> <th>Description</th> <th>Qty</th> <th>UOM</th> </tr> </thead> <tbody> <tr> <td>VE1170A0</td> <td>D16 OPAQUE NICKEL ELLIPTICAL SUPPORT</td> <td>1</td> <td>PZ</td> </tr> <tr> <td>VE1535A1</td> <td>230V WHITE LED</td> <td>1</td> <td>PZ</td> </tr> <tr> <td>VM1224A0</td> <td>65MY 220MM 2 COLOURS SHRINK TUBE</td> <td>0.200</td> <td>M</td> </tr> <tr> <td>VM1761A0</td> <td>D16 BLACK ELLIPTICAL SUPPORT</td> <td>1</td> <td>PZ</td> </tr> <tr> <td>VM1782A0</td> <td>INNER LAMP SUPPORT</td> <td>1</td> <td>PZ</td> </tr> <tr> <td>VM1902A0</td> <td>NEUTRAL GREEN PLASTIC COVER FOR</td> <td>1</td> <td>PZ</td> </tr> </tbody> </table>	Code	Description	Qty	UOM	VE1170A0	D16 OPAQUE NICKEL ELLIPTICAL SUPPORT	1	PZ	VE1535A1	230V WHITE LED	1	PZ	VM1224A0	65MY 220MM 2 COLOURS SHRINK TUBE	0.200	M	VM1761A0	D16 BLACK ELLIPTICAL SUPPORT	1	PZ	VM1782A0	INNER LAMP SUPPORT	1	PZ	VM1902A0	NEUTRAL GREEN PLASTIC COVER FOR	1	PZ
Code	Description	Qty	UOM																														
VE1170A0	D16 OPAQUE NICKEL ELLIPTICAL SUPPORT	1	PZ																														
VE1535A1	230V WHITE LED	1	PZ																														
VM1224A0	65MY 220MM 2 COLOURS SHRINK TUBE	0.200	M																														
VM1761A0	D16 BLACK ELLIPTICAL SUPPORT	1	PZ																														
VM1782A0	INNER LAMP SUPPORT	1	PZ																														
VM1902A0	NEUTRAL GREEN PLASTIC COVER FOR	1	PZ																														



COMPONENT			SPARE PART																										
Code	Description	Image	Code	Description	Components list																								
VE1535A	230V WHITE LED		KVE0102A	GOLDEN FLAME LIGHT COVER KIT	<table border="1"> <thead> <tr> <th>Code</th> <th>Description</th> <th>Qty</th> <th>UOM</th> </tr> </thead> <tbody> <tr> <td>VE1170A0</td> <td>D16 OPAQUE NICKEL ELLIPTICAL SUPPORT</td> <td>1</td> <td>PZ</td> </tr> <tr> <td>VE1535A1</td> <td>230V WHITE LED</td> <td>1</td> <td>PZ</td> </tr> <tr> <td>VM1761A0</td> <td>D16 BLACK ELLIPTICAL SUPPORT</td> <td>1</td> <td>PZ</td> </tr> <tr> <td>VM1762A0</td> <td>INNER LAMP SUPPORT</td> <td>1</td> <td>PZ</td> </tr> <tr> <td>VM1767A0</td> <td>GREEN PILOT LIGHT W/ GOLD FLAME</td> <td>1</td> <td>PZ</td> </tr> </tbody> </table>	Code	Description	Qty	UOM	VE1170A0	D16 OPAQUE NICKEL ELLIPTICAL SUPPORT	1	PZ	VE1535A1	230V WHITE LED	1	PZ	VM1761A0	D16 BLACK ELLIPTICAL SUPPORT	1	PZ	VM1762A0	INNER LAMP SUPPORT	1	PZ	VM1767A0	GREEN PILOT LIGHT W/ GOLD FLAME	1	PZ
			Code	Description	Qty	UOM																							
			VE1170A0	D16 OPAQUE NICKEL ELLIPTICAL SUPPORT	1	PZ																							
			VE1535A1	230V WHITE LED	1	PZ																							
			VM1761A0	D16 BLACK ELLIPTICAL SUPPORT	1	PZ																							
			VM1762A0	INNER LAMP SUPPORT	1	PZ																							
			VM1767A0	GREEN PILOT LIGHT W/ GOLD FLAME	1	PZ																							
			KVE0101A	SINUSOID LIGHT GREEN COVER KIT	<table border="1"> <thead> <tr> <th>Code</th> <th>Description</th> <th>Qty</th> <th>UOM</th> </tr> </thead> <tbody> <tr> <td>VE1170A0</td> <td>D16 OPAQUE NICKEL ELLIPTICAL SUPPORT</td> <td>1</td> <td>PZ</td> </tr> <tr> <td>VE1535A1</td> <td>230V WHITE LED</td> <td>1</td> <td>PZ</td> </tr> <tr> <td>VM1761A0</td> <td>D16 BLACK ELLIPTICAL SUPPORT</td> <td>1</td> <td>PZ</td> </tr> <tr> <td>VM1762A0</td> <td>INNER LAMP SUPPORT</td> <td>1</td> <td>PZ</td> </tr> <tr> <td>VM1765A0</td> <td>GREEN PILOT WITH GOLD SINUSOIDE</td> <td>1</td> <td>PZ</td> </tr> </tbody> </table>	Code	Description	Qty	UOM	VE1170A0	D16 OPAQUE NICKEL ELLIPTICAL SUPPORT	1	PZ	VE1535A1	230V WHITE LED	1	PZ	VM1761A0	D16 BLACK ELLIPTICAL SUPPORT	1	PZ	VM1762A0	INNER LAMP SUPPORT	1	PZ	VM1765A0	GREEN PILOT WITH GOLD SINUSOIDE	1	PZ
			Code	Description	Qty	UOM																							
			VE1170A0	D16 OPAQUE NICKEL ELLIPTICAL SUPPORT	1	PZ																							
			VE1535A1	230V WHITE LED	1	PZ																							
			VM1761A0	D16 BLACK ELLIPTICAL SUPPORT	1	PZ																							
VM1762A0	INNER LAMP SUPPORT	1	PZ																										
VM1765A0	GREEN PILOT WITH GOLD SINUSOIDE	1	PZ																										
KVE0100A	THERMOMETER LIGHT COVER KIT	<table border="1"> <thead> <tr> <th>Code</th> <th>Description</th> <th>Qty</th> <th>UOM</th> </tr> </thead> <tbody> <tr> <td>VE1530A0</td> <td>GOLD THERMOMETE R BLUE LIGHT COVER</td> <td>1</td> <td>PZ</td> </tr> <tr> <td>VE1535A1</td> <td>230V WHITE LED</td> <td>1</td> <td>PZ</td> </tr> <tr> <td>VM1224A0</td> <td>65MY 220MM 2 COLOURS SHRINK TUBE</td> <td>0.200</td> <td>M</td> </tr> <tr> <td>VM1761A0</td> <td>D16 BLACK ELLIPTICAL SUPPORT</td> <td>1</td> <td>PZ</td> </tr> <tr> <td>VM1762A0</td> <td>INNER LAMP SUPPORT</td> <td>1</td> <td>PZ</td> </tr> </tbody> </table>	Code	Description	Qty	UOM	VE1530A0	GOLD THERMOMETE R BLUE LIGHT COVER	1	PZ	VE1535A1	230V WHITE LED	1	PZ	VM1224A0	65MY 220MM 2 COLOURS SHRINK TUBE	0.200	M	VM1761A0	D16 BLACK ELLIPTICAL SUPPORT	1	PZ	VM1762A0	INNER LAMP SUPPORT	1	PZ			
Code	Description	Qty	UOM																										
VE1530A0	GOLD THERMOMETE R BLUE LIGHT COVER	1	PZ																										
VE1535A1	230V WHITE LED	1	PZ																										
VM1224A0	65MY 220MM 2 COLOURS SHRINK TUBE	0.200	M																										
VM1761A0	D16 BLACK ELLIPTICAL SUPPORT	1	PZ																										
VM1762A0	INNER LAMP SUPPORT	1	PZ																										
KVE0011A	SP KNOBS AND LIGHTS KIT	<table border="1"> <thead> <tr> <th>Code</th> <th>Description</th> <th>Qty</th> <th>UOM</th> </tr> </thead> <tbody> <tr> <td>MN1105A0</td> <td>120-400C XP THERMOSTAT KNOB</td> <td>1</td> <td>PZ</td> </tr> <tr> <td>MN1110A0</td> <td>XP NEUTRAL INDEX DIAL</td> <td>1</td> <td>PZ</td> </tr> </tbody> </table>	Code	Description	Qty	UOM	MN1105A0	120-400C XP THERMOSTAT KNOB	1	PZ	MN1110A0	XP NEUTRAL INDEX DIAL	1	PZ															
Code	Description	Qty	UOM																										
MN1105A0	120-400C XP THERMOSTAT KNOB	1	PZ																										
MN1110A0	XP NEUTRAL INDEX DIAL	1	PZ																										





COMPONENT			SPARE PART																																											
Code	Description	Image	Code	Description	Components list																																									
VE1535A	230V WHITE LED		KVE0011A	SP KNOBS AND LIGHTS KIT	<table border="1"> <thead> <tr> <th>Code</th> <th>Description</th> <th>Qty</th> <th>UOM</th> </tr> </thead> <tbody> <tr> <td>VE1530A0</td> <td>GOLD THERMOMETE R BLUE LIGHT COVER</td> <td>1</td> <td>PZ</td> </tr> <tr> <td>VE1535A1</td> <td>230V WHITE LED</td> <td>1</td> <td>PZ</td> </tr> <tr> <td>VE1561A0</td> <td>NA/NA BIPOLAR SWITCH</td> <td>1</td> <td>PZ</td> </tr> <tr> <td>VM1761A0</td> <td>D16 BLACK ELLIPTICAL SUPPORT</td> <td>2</td> <td>PZ</td> </tr> <tr> <td>VM1762A0</td> <td>INNER LAMP SUPPORT</td> <td>1</td> <td>PZ</td> </tr> <tr> <td>VM1776A0</td> <td>"GOLD "0-1" MATT SILVER KEY"</td> <td>1</td> <td>PZ</td> </tr> </tbody> </table>	Code	Description	Qty	UOM	VE1530A0	GOLD THERMOMETE R BLUE LIGHT COVER	1	PZ	VE1535A1	230V WHITE LED	1	PZ	VE1561A0	NA/NA BIPOLAR SWITCH	1	PZ	VM1761A0	D16 BLACK ELLIPTICAL SUPPORT	2	PZ	VM1762A0	INNER LAMP SUPPORT	1	PZ	VM1776A0	"GOLD "0-1" MATT SILVER KEY"	1	PZ													
			Code	Description	Qty	UOM																																								
			VE1530A0	GOLD THERMOMETE R BLUE LIGHT COVER	1	PZ																																								
VE1535A1	230V WHITE LED	1	PZ																																											
VE1561A0	NA/NA BIPOLAR SWITCH	1	PZ																																											
VM1761A0	D16 BLACK ELLIPTICAL SUPPORT	2	PZ																																											
VM1762A0	INNER LAMP SUPPORT	1	PZ																																											
VM1776A0	"GOLD "0-1" MATT SILVER KEY"	1	PZ																																											
KVE0008A	XL PILOT BLUE LIGHTS KIT	<table border="1"> <thead> <tr> <th>Code</th> <th>Description</th> <th>Qty</th> <th>UOM</th> </tr> </thead> <tbody> <tr> <td>VE1170A0</td> <td>D16 OPAQUE NICKEL ELLIPTICAL SUPPORT</td> <td>3</td> <td>PZ</td> </tr> <tr> <td>VE1530A0</td> <td>GOLD THERMOMETE R BLUE LIGHT COVER</td> <td>1</td> <td>PZ</td> </tr> <tr> <td>VE1535A1</td> <td>230V WHITE LED</td> <td>1</td> <td>PZ</td> </tr> <tr> <td>VE1561A0</td> <td>NA/NA BIPOLAR SWITCH</td> <td>1</td> <td>PZ</td> </tr> <tr> <td>VE1562A0</td> <td>UNIPOLAR NA PUSH BUTTO</td> <td>1</td> <td>PZ</td> </tr> <tr> <td>VM1224A0</td> <td>65MY 220MM 2 COLOURS SHRINK TUBE</td> <td>0.200</td> <td>M</td> </tr> <tr> <td>VM1761A0</td> <td>D16 BLACK ELLIPTICAL SUPPORT</td> <td>3</td> <td>PZ</td> </tr> <tr> <td>VM1762A0</td> <td>INNER LAMP SUPPORT</td> <td>1</td> <td>PZ</td> </tr> <tr> <td>VM1775A0</td> <td>"OPAQUE SILVER KEY WITH GOLD "CLOUD"</td> <td>1</td> <td>PZ</td> </tr> <tr> <td>VM1776A0</td> <td>"GOLD "0-1" MATT SILVER KEY"</td> <td>1</td> <td>PZ</td> </tr> </tbody> </table>	Code	Description	Qty	UOM	VE1170A0	D16 OPAQUE NICKEL ELLIPTICAL SUPPORT	3	PZ	VE1530A0	GOLD THERMOMETE R BLUE LIGHT COVER	1	PZ	VE1535A1	230V WHITE LED	1	PZ	VE1561A0	NA/NA BIPOLAR SWITCH	1	PZ	VE1562A0	UNIPOLAR NA PUSH BUTTO	1	PZ	VM1224A0	65MY 220MM 2 COLOURS SHRINK TUBE	0.200	M	VM1761A0	D16 BLACK ELLIPTICAL SUPPORT	3	PZ	VM1762A0	INNER LAMP SUPPORT	1	PZ	VM1775A0	"OPAQUE SILVER KEY WITH GOLD "CLOUD"	1	PZ	VM1776A0	"GOLD "0-1" MATT SILVER KEY"	1	PZ
Code	Description	Qty	UOM																																											
VE1170A0	D16 OPAQUE NICKEL ELLIPTICAL SUPPORT	3	PZ																																											
VE1530A0	GOLD THERMOMETE R BLUE LIGHT COVER	1	PZ																																											
VE1535A1	230V WHITE LED	1	PZ																																											
VE1561A0	NA/NA BIPOLAR SWITCH	1	PZ																																											
VE1562A0	UNIPOLAR NA PUSH BUTTO	1	PZ																																											
VM1224A0	65MY 220MM 2 COLOURS SHRINK TUBE	0.200	M																																											
VM1761A0	D16 BLACK ELLIPTICAL SUPPORT	3	PZ																																											
VM1762A0	INNER LAMP SUPPORT	1	PZ																																											
VM1775A0	"OPAQUE SILVER KEY WITH GOLD "CLOUD"	1	PZ																																											
VM1776A0	"GOLD "0-1" MATT SILVER KEY"	1	PZ																																											
KVE0007A	XF-XG LED AND LED COVERS KIT	<table border="1"> <thead> <tr> <th>Code</th> <th>Description</th> <th>Qty</th> <th>UOM</th> </tr> </thead> <tbody> <tr> <td>VE1170A0</td> <td>D16 OPAQUE NICKEL ELLIPTICAL SUPPORT</td> <td>5</td> <td>PZ</td> </tr> </tbody> </table>	Code	Description	Qty	UOM	VE1170A0	D16 OPAQUE NICKEL ELLIPTICAL SUPPORT	5	PZ																																				
Code	Description	Qty	UOM																																											
VE1170A0	D16 OPAQUE NICKEL ELLIPTICAL SUPPORT	5	PZ																																											



COMPONENT			SPARE PART																																																						
Code	Description	Image	Code	Description	Components list																																																				
VE1535A	230V WHITE LED		KVE0007A	XF-XG LED AND LED COVERS KIT	<table border="1"> <thead> <tr> <th>Code</th> <th>Description</th> <th>Qty</th> <th>UOM</th> </tr> </thead> <tbody> <tr> <td>VE1530A0</td> <td>GOLD THERMOMETE R BLUE LIGHT COVER</td> <td>1</td> <td>PZ</td> </tr> <tr> <td>VE1535A1</td> <td>230V WHITE LED</td> <td>1</td> <td>PZ</td> </tr> <tr> <td>VE1562A0</td> <td>UNIPOLAR NA PUSH BUTTO</td> <td>1</td> <td>PZ</td> </tr> <tr> <td>VE1585A0</td> <td>BLUE LIGHT COVER GOLD SINUSOID</td> <td>1</td> <td>PZ</td> </tr> <tr> <td>VM1224A0</td> <td>65MY 220MM 2 COLOURS SHRINK TUBE</td> <td>0.200</td> <td>M</td> </tr> <tr> <td>VM1761A0</td> <td>D16 BLACK ELLIPTICAL SUPPORT</td> <td>5</td> <td>PZ</td> </tr> <tr> <td>VM1762A0</td> <td>INNER LAMP SUPPORT</td> <td>4</td> <td>PZ</td> </tr> <tr> <td>VM1767A0</td> <td>GREEN PILOT LIGHT W/ GOLD FLAME</td> <td>1</td> <td>PZ</td> </tr> <tr> <td>VM1774A0</td> <td>SILVER OPAQUE KEY W/ GOLD FLAME</td> <td>1</td> <td>PZ</td> </tr> <tr> <td>VM1775A0</td> <td>*OPAQUE SILVER KEY WITH GOLD "CLOUD"</td> <td>1</td> <td>PZ</td> </tr> <tr> <td>VM1902A0</td> <td>NEUTRAL GREEN PLASTIC COVER FOR</td> <td>1</td> <td>PZ</td> </tr> <tr> <td>VM1903A0</td> <td>GREEN PILOT WITH GOLD "CLOUD"</td> <td>1</td> <td>PZ</td> </tr> </tbody> </table>	Code	Description	Qty	UOM	VE1530A0	GOLD THERMOMETE R BLUE LIGHT COVER	1	PZ	VE1535A1	230V WHITE LED	1	PZ	VE1562A0	UNIPOLAR NA PUSH BUTTO	1	PZ	VE1585A0	BLUE LIGHT COVER GOLD SINUSOID	1	PZ	VM1224A0	65MY 220MM 2 COLOURS SHRINK TUBE	0.200	M	VM1761A0	D16 BLACK ELLIPTICAL SUPPORT	5	PZ	VM1762A0	INNER LAMP SUPPORT	4	PZ	VM1767A0	GREEN PILOT LIGHT W/ GOLD FLAME	1	PZ	VM1774A0	SILVER OPAQUE KEY W/ GOLD FLAME	1	PZ	VM1775A0	*OPAQUE SILVER KEY WITH GOLD "CLOUD"	1	PZ	VM1902A0	NEUTRAL GREEN PLASTIC COVER FOR	1	PZ	VM1903A0	GREEN PILOT WITH GOLD "CLOUD"	1	PZ
			Code	Description	Qty	UOM																																																			
VE1530A0	GOLD THERMOMETE R BLUE LIGHT COVER	1	PZ																																																						
VE1535A1	230V WHITE LED	1	PZ																																																						
VE1562A0	UNIPOLAR NA PUSH BUTTO	1	PZ																																																						
VE1585A0	BLUE LIGHT COVER GOLD SINUSOID	1	PZ																																																						
VM1224A0	65MY 220MM 2 COLOURS SHRINK TUBE	0.200	M																																																						
VM1761A0	D16 BLACK ELLIPTICAL SUPPORT	5	PZ																																																						
VM1762A0	INNER LAMP SUPPORT	4	PZ																																																						
VM1767A0	GREEN PILOT LIGHT W/ GOLD FLAME	1	PZ																																																						
VM1774A0	SILVER OPAQUE KEY W/ GOLD FLAME	1	PZ																																																						
VM1775A0	*OPAQUE SILVER KEY WITH GOLD "CLOUD"	1	PZ																																																						
VM1902A0	NEUTRAL GREEN PLASTIC COVER FOR	1	PZ																																																						
VM1903A0	GREEN PILOT WITH GOLD "CLOUD"	1	PZ																																																						
KLP1014A	SINUSOID LED LIGHT+COVER+SUPPORT KIT	<table border="1"> <thead> <tr> <th>Code</th> <th>Description</th> <th>Qty</th> <th>UOM</th> </tr> </thead> <tbody> <tr> <td>VE1170A0</td> <td>D16 OPAQUE NICKEL ELLIPTICAL SUPPORT</td> <td>2</td> <td>PZ</td> </tr> <tr> <td>VE1535A1</td> <td>230V WHITE LED</td> <td>2</td> <td>PZ</td> </tr> <tr> <td>VE1585A0</td> <td>BLUE LIGHT COVER GOLD SINUSOID</td> <td>2</td> <td>PZ</td> </tr> <tr> <td>VM1224A0</td> <td>65MY 220MM 2 COLOURS SHRINK TUBE</td> <td>0.200</td> <td>M</td> </tr> <tr> <td>VM1762A0</td> <td>INNER LAMP SUPPORT</td> <td>2</td> <td>PZ</td> </tr> <tr> <td>VM2009A0</td> <td>SILVER SUPPORT D16</td> <td>1</td> <td>PZ</td> </tr> </tbody> </table>	Code	Description	Qty	UOM	VE1170A0	D16 OPAQUE NICKEL ELLIPTICAL SUPPORT	2	PZ	VE1535A1	230V WHITE LED	2	PZ	VE1585A0	BLUE LIGHT COVER GOLD SINUSOID	2	PZ	VM1224A0	65MY 220MM 2 COLOURS SHRINK TUBE	0.200	M	VM1762A0	INNER LAMP SUPPORT	2	PZ	VM2009A0	SILVER SUPPORT D16	1	PZ																											
Code	Description	Qty	UOM																																																						
VE1170A0	D16 OPAQUE NICKEL ELLIPTICAL SUPPORT	2	PZ																																																						
VE1535A1	230V WHITE LED	2	PZ																																																						
VE1585A0	BLUE LIGHT COVER GOLD SINUSOID	2	PZ																																																						
VM1224A0	65MY 220MM 2 COLOURS SHRINK TUBE	0.200	M																																																						
VM1762A0	INNER LAMP SUPPORT	2	PZ																																																						
VM2009A0	SILVER SUPPORT D16	1	PZ																																																						

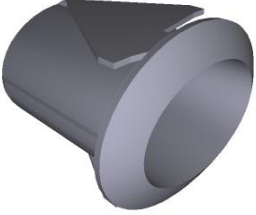
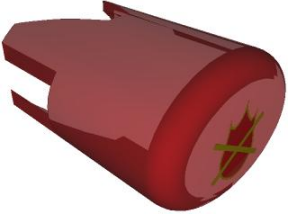

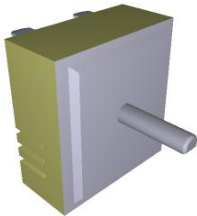

COMPONENT			SPARE PART																										
Code	Description	Image	Code	Description	Components list																								
VE1535A	230V WHITE LED		KLP1012A	BLUE LIGHT THERMOMETER KIT	<table border="1"> <thead> <tr> <th>Code</th> <th>Description</th> <th>Qty</th> <th>UOM</th> </tr> </thead> <tbody> <tr> <td>VE1170A0</td> <td>D16 OPAQUE NICKEL ELLIPTICAL SUPPORT</td> <td>1</td> <td>PZ</td> </tr> <tr> <td>VE1530A0</td> <td>GOLD THERMOMETE R BLUE LIGHT COVER</td> <td>1</td> <td>PZ</td> </tr> <tr> <td>VE1535A1</td> <td>230V WHITE LED</td> <td>1</td> <td>PZ</td> </tr> <tr> <td>VM1224A0</td> <td>65MY 220MM COLOURS SHRINK TUBE</td> <td>2 0.200</td> <td>M</td> </tr> <tr> <td>VM1762A0</td> <td>INNER LAMP SUPPORT</td> <td>1</td> <td>PZ</td> </tr> </tbody> </table>	Code	Description	Qty	UOM	VE1170A0	D16 OPAQUE NICKEL ELLIPTICAL SUPPORT	1	PZ	VE1530A0	GOLD THERMOMETE R BLUE LIGHT COVER	1	PZ	VE1535A1	230V WHITE LED	1	PZ	VM1224A0	65MY 220MM COLOURS SHRINK TUBE	2 0.200	M	VM1762A0	INNER LAMP SUPPORT	1	PZ
			Code	Description	Qty	UOM																							
VE1170A0	D16 OPAQUE NICKEL ELLIPTICAL SUPPORT	1	PZ																										
VE1530A0	GOLD THERMOMETE R BLUE LIGHT COVER	1	PZ																										
VE1535A1	230V WHITE LED	1	PZ																										
VM1224A0	65MY 220MM COLOURS SHRINK TUBE	2 0.200	M																										
VM1762A0	INNER LAMP SUPPORT	1	PZ																										
KLP1010A	THERMOSTAT GREEN LIGHT KIT	<table border="1"> <thead> <tr> <th>Code</th> <th>Description</th> <th>Qty</th> <th>UOM</th> </tr> </thead> <tbody> <tr> <td>VE1170A0</td> <td>D16 OPAQUE NICKEL ELLIPTICAL SUPPORT</td> <td>1</td> <td>PZ</td> </tr> <tr> <td>VE1535A1</td> <td>230V WHITE LED</td> <td>1</td> <td>PZ</td> </tr> <tr> <td>VM1762A0</td> <td>INNER LAMP SUPPORT</td> <td>1</td> <td>PZ</td> </tr> <tr> <td>VM1764A0</td> <td>GREEN PILOT WITH GOLD THERMOMETE</td> <td>1</td> <td>PZ</td> </tr> </tbody> </table>	Code	Description	Qty	UOM	VE1170A0	D16 OPAQUE NICKEL ELLIPTICAL SUPPORT	1	PZ	VE1535A1	230V WHITE LED	1	PZ	VM1762A0	INNER LAMP SUPPORT	1	PZ	VM1764A0	GREEN PILOT WITH GOLD THERMOMETE	1	PZ							
Code	Description	Qty	UOM																										
VE1170A0	D16 OPAQUE NICKEL ELLIPTICAL SUPPORT	1	PZ																										
VE1535A1	230V WHITE LED	1	PZ																										
VM1762A0	INNER LAMP SUPPORT	1	PZ																										
VM1764A0	GREEN PILOT WITH GOLD THERMOMETE	1	PZ																										
VM2009A	ELLIPTICAL SILVER SUPPORT D16		KVM2009A	D16 SILVER ELLIPTICAL SUPPORT KIT	<table border="1"> <thead> <tr> <th>Code</th> <th>Description</th> <th>Qty</th> <th>UOM</th> </tr> </thead> <tbody> <tr> <td>VM1224A0</td> <td>65MY 220MM COLOURS SHRINK TUBE</td> <td>2 0.150</td> <td>M</td> </tr> <tr> <td>VM2009A0</td> <td>ELLIPTICAL SILVER SUPPORT D16</td> <td>1</td> <td>PZ</td> </tr> </tbody> </table>	Code	Description	Qty	UOM	VM1224A0	65MY 220MM COLOURS SHRINK TUBE	2 0.150	M	VM2009A0	ELLIPTICAL SILVER SUPPORT D16	1	PZ												
Code	Description	Qty	UOM																										
VM1224A0	65MY 220MM COLOURS SHRINK TUBE	2 0.150	M																										
VM2009A0	ELLIPTICAL SILVER SUPPORT D16	1	PZ																										
VE1624B	RED PILOT LIGHT W/ GOLD FLAME		VE1624B0	RED PILOT LIGHT W/ GOLD FLAME																									



COMPONENT			SPARE PART																																														
Code	Description	Image	Code	Description	Components list																																												
VM1972A	BAKERLUX/CHEFLUX MANUAL CONTROL PANEL		KVM1972A	CL/BL MANUAL CONTROL BOARD KIT	<table border="1"> <thead> <tr> <th>Code</th> <th>Description</th> <th>Qty</th> <th>UOM</th> </tr> </thead> <tbody> <tr> <td>VE1530A0</td> <td>GOLD THERMOMETE R BLUE LIGHT COVER</td> <td>1</td> <td>PZ</td> </tr> <tr> <td>VE1535A1</td> <td>230V WHITE LED</td> <td>2</td> <td>PZ</td> </tr> <tr> <td>VE1561A0</td> <td>NA/NA BIPOLAR SWITCH</td> <td>1</td> <td>PZ</td> </tr> <tr> <td>VE1585A0</td> <td>BLUE LIGHT COVER GOLD SINUSOID</td> <td>1</td> <td>PZ</td> </tr> <tr> <td>VM1762A0</td> <td>INNER LAMP SUPPORT</td> <td>2</td> <td>PZ</td> </tr> <tr> <td>VM1794A0</td> <td>250X4.8 PA66 BLACK CLAMP</td> <td>2</td> <td>PZ</td> </tr> <tr> <td>VM1972A0</td> <td>BAKERLUX/CH EFLUX MANUAL CONTROL PANEL</td> <td>1</td> <td>PZ</td> </tr> <tr> <td>VM2007A0</td> <td>FAN SPEED SILVER BUTTON</td> <td>1</td> <td>PZ</td> </tr> <tr> <td>VM2009A0</td> <td>ELLIPTICAL SILVER SUPPORT D16</td> <td>3</td> <td>PZ</td> </tr> <tr> <td>VM2103A0</td> <td>CLAMP LOCK</td> <td>2</td> <td>PZ</td> </tr> </tbody> </table>	Code	Description	Qty	UOM	VE1530A0	GOLD THERMOMETE R BLUE LIGHT COVER	1	PZ	VE1535A1	230V WHITE LED	2	PZ	VE1561A0	NA/NA BIPOLAR SWITCH	1	PZ	VE1585A0	BLUE LIGHT COVER GOLD SINUSOID	1	PZ	VM1762A0	INNER LAMP SUPPORT	2	PZ	VM1794A0	250X4.8 PA66 BLACK CLAMP	2	PZ	VM1972A0	BAKERLUX/CH EFLUX MANUAL CONTROL PANEL	1	PZ	VM2007A0	FAN SPEED SILVER BUTTON	1	PZ	VM2009A0	ELLIPTICAL SILVER SUPPORT D16	3	PZ	VM2103A0	CLAMP LOCK	2	PZ
Code	Description	Qty	UOM																																														
VE1530A0	GOLD THERMOMETE R BLUE LIGHT COVER	1	PZ																																														
VE1535A1	230V WHITE LED	2	PZ																																														
VE1561A0	NA/NA BIPOLAR SWITCH	1	PZ																																														
VE1585A0	BLUE LIGHT COVER GOLD SINUSOID	1	PZ																																														
VM1762A0	INNER LAMP SUPPORT	2	PZ																																														
VM1794A0	250X4.8 PA66 BLACK CLAMP	2	PZ																																														
VM1972A0	BAKERLUX/CH EFLUX MANUAL CONTROL PANEL	1	PZ																																														
VM2007A0	FAN SPEED SILVER BUTTON	1	PZ																																														
VM2009A0	ELLIPTICAL SILVER SUPPORT D16	3	PZ																																														
VM2103A0	CLAMP LOCK	2	PZ																																														
VM2007A	FAN SPEED SILVER BUTTON		KVM2007A	FAN SPEED BUTTON KIT	<table border="1"> <thead> <tr> <th>Code</th> <th>Description</th> <th>Qty</th> <th>UOM</th> </tr> </thead> <tbody> <tr> <td>VM1224A0</td> <td>65MY 220MM 2 COLOURS SHRINK TUBE</td> <td>0.150</td> <td>M</td> </tr> <tr> <td>VM2007A0</td> <td>FAN SPEED SILVER BUTTON</td> <td>1</td> <td>PZ</td> </tr> </tbody> </table>	Code	Description	Qty	UOM	VM1224A0	65MY 220MM 2 COLOURS SHRINK TUBE	0.150	M	VM2007A0	FAN SPEED SILVER BUTTON	1	PZ																																
Code	Description	Qty	UOM																																														
VM1224A0	65MY 220MM 2 COLOURS SHRINK TUBE	0.150	M																																														
VM2007A0	FAN SPEED SILVER BUTTON	1	PZ																																														
VE1556A	THERMAL SWITCH 240V		KVE1556A	ENERGY REGULATOR KIT	<table border="1"> <thead> <tr> <th>Code</th> <th>Description</th> <th>Qty</th> <th>UOM</th> </tr> </thead> <tbody> <tr> <td>MN1000A0</td> <td>SILVER INDEX KNOB</td> <td>1</td> <td>PZ</td> </tr> <tr> <td>MN1085A0</td> <td>PLASTIC DIAL ENERGY REGULATOR</td> <td>1</td> <td>PZ</td> </tr> <tr> <td>VE1556A0</td> <td>THERMAL SWITCH 240V</td> <td>1</td> <td>PZ</td> </tr> <tr> <td>VI1850A0</td> <td>M4X6 NICKEL PLATED FIXING SCREW</td> <td>2</td> <td>PZ</td> </tr> </tbody> </table>	Code	Description	Qty	UOM	MN1000A0	SILVER INDEX KNOB	1	PZ	MN1085A0	PLASTIC DIAL ENERGY REGULATOR	1	PZ	VE1556A0	THERMAL SWITCH 240V	1	PZ	VI1850A0	M4X6 NICKEL PLATED FIXING SCREW	2	PZ																								
Code	Description	Qty	UOM																																														
MN1000A0	SILVER INDEX KNOB	1	PZ																																														
MN1085A0	PLASTIC DIAL ENERGY REGULATOR	1	PZ																																														
VE1556A0	THERMAL SWITCH 240V	1	PZ																																														
VI1850A0	M4X6 NICKEL PLATED FIXING SCREW	2	PZ																																														

COMPONENT			SPARE PART																						
Code	Description	Image	Code	Description	Components list																				
MN1112A	CHEFLUX BAKERLUX TIMER KNOB		KMN1112A	CHEFLUX/BAKERLUX TIMER KNOB KIT	<table border="1"> <thead> <tr> <th>Code</th> <th>Description</th> <th>Qty</th> <th>UOM</th> </tr> </thead> <tbody> <tr> <td>MN1112A1</td> <td>CHEFLUX BAKERLUX TIMER KNOB</td> <td>1</td> <td>PZ</td> </tr> <tr> <td>VM1224A0</td> <td>65MY 220MM 2 COLOURS SHRINK TUBE</td> <td>0.200</td> <td>M</td> </tr> </tbody> </table>	Code	Description	Qty	UOM	MN1112A1	CHEFLUX BAKERLUX TIMER KNOB	1	PZ	VM1224A0	65MY 220MM 2 COLOURS SHRINK TUBE	0.200	M								
Code	Description	Qty	UOM																						
MN1112A1	CHEFLUX BAKERLUX TIMER KNOB	1	PZ																						
VM1224A0	65MY 220MM 2 COLOURS SHRINK TUBE	0.200	M																						
MN1111A	CHEFLUX BAKERLUX THERMOSTAT KNOB		KMN1111A	CL/BL THERMOSTAT KNOB (CELSIUS)	<table border="1"> <thead> <tr> <th>Code</th> <th>Description</th> <th>Qty</th> <th>UOM</th> </tr> </thead> <tbody> <tr> <td>MN1111A1</td> <td>CHEFLUX BAKERLUX THERMOSTAT KNOB</td> <td>1</td> <td>PZ</td> </tr> <tr> <td>VM1224A0</td> <td>65MY 220MM 2 COLOURS SHRINK TUBE</td> <td>0.200</td> <td>M</td> </tr> </tbody> </table>	Code	Description	Qty	UOM	MN1111A1	CHEFLUX BAKERLUX THERMOSTAT KNOB	1	PZ	VM1224A0	65MY 220MM 2 COLOURS SHRINK TUBE	0.200	M								
Code	Description	Qty	UOM																						
MN1111A1	CHEFLUX BAKERLUX THERMOSTAT KNOB	1	PZ																						
VM1224A0	65MY 220MM 2 COLOURS SHRINK TUBE	0.200	M																						
MN1113A	CHEFLUX BAKERLUX HUMIDITY CONTROL KNOB		KMN1113A	CL/BL HUMIDITY CONTROL KNOB KIT	<table border="1"> <thead> <tr> <th>Code</th> <th>Description</th> <th>Qty</th> <th>UOM</th> </tr> </thead> <tbody> <tr> <td>MN1113A2</td> <td>CHEFLUX BAKERLUX HUMIDITY CONTROL KNOB</td> <td>1</td> <td>PZ</td> </tr> <tr> <td>VM1224A0</td> <td>65MY 220MM 2 COLOURS SHRINK TUBE</td> <td>0.200</td> <td>M</td> </tr> </tbody> </table>	Code	Description	Qty	UOM	MN1113A2	CHEFLUX BAKERLUX HUMIDITY CONTROL KNOB	1	PZ	VM1224A0	65MY 220MM 2 COLOURS SHRINK TUBE	0.200	M								
Code	Description	Qty	UOM																						
MN1113A2	CHEFLUX BAKERLUX HUMIDITY CONTROL KNOB	1	PZ																						
VM1224A0	65MY 220MM 2 COLOURS SHRINK TUBE	0.200	M																						
0N1371B	CHEF-BAKERLUX GAS FUMES DRAFT SWITCH		K0N1371B	LUX FUMES DRAFT SWITCH KIT	<table border="1"> <thead> <tr> <th>Code</th> <th>Description</th> <th>Qty</th> <th>UOM</th> </tr> </thead> <tbody> <tr> <td>0N1047A0</td> <td>XG DRAFT SWITCH ENTRANCE RING</td> <td>1</td> <td>PZ</td> </tr> <tr> <td>0N1356A0</td> <td>XVC FUMES SWITCH SIDE PLATE</td> <td>2</td> <td>PZ</td> </tr> <tr> <td>0N1371B0</td> <td>CHEF-BAKERLUX GAS FUMES DRAFT SWITCH</td> <td>1</td> <td>PZ</td> </tr> <tr> <td>VI1220A1</td> <td>4,2X12 TCB SELF-TAPPING SCREW</td> <td>24</td> <td>PZ</td> </tr> </tbody> </table>	Code	Description	Qty	UOM	0N1047A0	XG DRAFT SWITCH ENTRANCE RING	1	PZ	0N1356A0	XVC FUMES SWITCH SIDE PLATE	2	PZ	0N1371B0	CHEF-BAKERLUX GAS FUMES DRAFT SWITCH	1	PZ	VI1220A1	4,2X12 TCB SELF-TAPPING SCREW	24	PZ
Code	Description	Qty	UOM																						
0N1047A0	XG DRAFT SWITCH ENTRANCE RING	1	PZ																						
0N1356A0	XVC FUMES SWITCH SIDE PLATE	2	PZ																						
0N1371B0	CHEF-BAKERLUX GAS FUMES DRAFT SWITCH	1	PZ																						
VI1220A1	4,2X12 TCB SELF-TAPPING SCREW	24	PZ																						

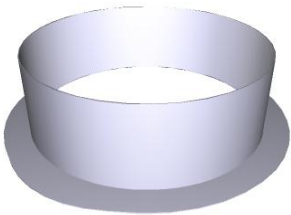

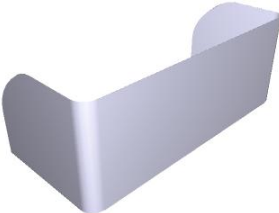
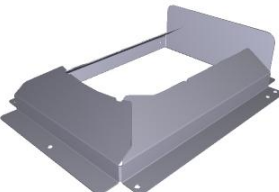
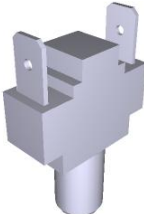

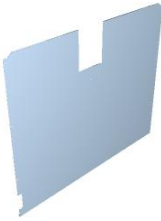
COMPONENT			SPARE PART																										
Code	Description	Image	Code	Description	Components list																								
0N1047A	XG DRAFT SWITCH ENTRANCE RING		0N1047A0	XG DRAFT SWITCH ENTRANCE RING																									
0N1356A	XVC FUMES SWITCH SIDE PLATE		0N1356A0	XVC FUMES SWITCH SIDE PLATE																									
0N1210A	XVC GAS DRAFT STOPPER EXTERNAL COVER		0N1210A3	XVC GAS DRAFT STOPPER EXTERNAL COVER																									
0N1379A	HEAT EXCHANGER LATERAL PANEL		0N1379A0	HEAT EXCHANGER LATERAL PANEL																									
VE1562A	UNIPOLAR NA PUSH BUTTON		KVE0107A	SILVER CLOUD LIGHT COVER KIT	<table border="1"> <thead> <tr> <th>Code</th> <th>Description</th> <th>Qty</th> <th>UOM</th> </tr> </thead> <tbody> <tr> <td>VE1170A0</td> <td>D16 OPAQUE NICKEL ELLIPTICAL SUPPORT</td> <td>1</td> <td>PZ</td> </tr> <tr> <td>VE1562A0</td> <td>UNIPOLAR NA PUSH BUTTO</td> <td>1</td> <td>PZ</td> </tr> <tr> <td>VM1224A0</td> <td>65MY 220MM 2 COLOURS SHRINK TUBE</td> <td>0.200</td> <td>M</td> </tr> <tr> <td>VM1761A0</td> <td>D16 BLACK ELLIPTICAL SUPPORT</td> <td>1</td> <td>PZ</td> </tr> <tr> <td>VM1775A0</td> <td>*OPAQUE SILVER KEY WITH GOLD "CLOUD"</td> <td>1</td> <td>PZ</td> </tr> </tbody> </table>	Code	Description	Qty	UOM	VE1170A0	D16 OPAQUE NICKEL ELLIPTICAL SUPPORT	1	PZ	VE1562A0	UNIPOLAR NA PUSH BUTTO	1	PZ	VM1224A0	65MY 220MM 2 COLOURS SHRINK TUBE	0.200	M	VM1761A0	D16 BLACK ELLIPTICAL SUPPORT	1	PZ	VM1775A0	*OPAQUE SILVER KEY WITH GOLD "CLOUD"	1	PZ
Code	Description	Qty	UOM																										
VE1170A0	D16 OPAQUE NICKEL ELLIPTICAL SUPPORT	1	PZ																										
VE1562A0	UNIPOLAR NA PUSH BUTTO	1	PZ																										
VM1224A0	65MY 220MM 2 COLOURS SHRINK TUBE	0.200	M																										
VM1761A0	D16 BLACK ELLIPTICAL SUPPORT	1	PZ																										
VM1775A0	*OPAQUE SILVER KEY WITH GOLD "CLOUD"	1	PZ																										

COMPONENT			SPARE PART																						
Code	Description	Image	Code	Description	Components list																				
VE1562A	UNIPOLAR NA PUSH BUTTON		KVE0106A	SILVER FLAME LIGHT COVER KIT	<table border="1"> <thead> <tr> <th>Code</th> <th>Description</th> <th>Qty</th> <th>UOM</th> </tr> </thead> <tbody> <tr> <td>VE1170A0</td> <td>D16 OPAQUE NICKEL ELLIPTICAL SUPPORT</td> <td>1</td> <td>PZ</td> </tr> <tr> <td>VE1562A0</td> <td>UNIPOLAR NA PUSH BUTTO</td> <td>1</td> <td>PZ</td> </tr> <tr> <td>VM1761A0</td> <td>D16 BLACK ELLIPTICAL SUPPORT</td> <td>1</td> <td>PZ</td> </tr> <tr> <td>VM1774A0</td> <td>SILVER OPAQUE KEY W/ GOLD FLAME</td> <td>1</td> <td>PZ</td> </tr> </tbody> </table>	Code	Description	Qty	UOM	VE1170A0	D16 OPAQUE NICKEL ELLIPTICAL SUPPORT	1	PZ	VE1562A0	UNIPOLAR NA PUSH BUTTO	1	PZ	VM1761A0	D16 BLACK ELLIPTICAL SUPPORT	1	PZ	VM1774A0	SILVER OPAQUE KEY W/ GOLD FLAME	1	PZ
Code	Description	Qty	UOM																						
VE1170A0	D16 OPAQUE NICKEL ELLIPTICAL SUPPORT	1	PZ																						
VE1562A0	UNIPOLAR NA PUSH BUTTO	1	PZ																						
VM1761A0	D16 BLACK ELLIPTICAL SUPPORT	1	PZ																						
VM1774A0	SILVER OPAQUE KEY W/ GOLD FLAME	1	PZ																						
VM2009A	ELLIPTICAL SILVER SUPPORT D16		KVM2009A	D16 SILVER ELLIPTICAL SUPPORT KIT	<table border="1"> <thead> <tr> <th>Code</th> <th>Description</th> <th>Qty</th> <th>UOM</th> </tr> </thead> <tbody> <tr> <td>VM1224A0</td> <td>65MY 220MM 2 COLOURS SHRINK TUBE</td> <td>0.150</td> <td>M</td> </tr> <tr> <td>VM2009A0</td> <td>ELLIPTICAL SILVER SUPPORT D16</td> <td>1</td> <td>PZ</td> </tr> </tbody> </table>	Code	Description	Qty	UOM	VM1224A0	65MY 220MM 2 COLOURS SHRINK TUBE	0.150	M	VM2009A0	ELLIPTICAL SILVER SUPPORT D16	1	PZ								
Code	Description	Qty	UOM																						
VM1224A0	65MY 220MM 2 COLOURS SHRINK TUBE	0.150	M																						
VM2009A0	ELLIPTICAL SILVER SUPPORT D16	1	PZ																						
VM2078A	BLACK FLAME MATT SILVER BUTTON		VM2078A0	BLACK FLAME MATT SILVER BUTTON																					
0F1463A	CHEF-BAKERLUX 89- EXTERNAL BACK PANEL		0F1463A0	CHEF-BAKERLUX 89- EXTERNAL BACK PANEL																					
VM2035A	DRAIN PIPE SUPPORT		KVM2035A	DRAIN PIPE SUPPORT 2 PCS. KI	<table border="1"> <thead> <tr> <th>Code</th> <th>Description</th> <th>Qty</th> <th>UOM</th> </tr> </thead> <tbody> <tr> <td>VM1224A0</td> <td>65MY 220MM 2 COLOURS SHRINK TUBE</td> <td>0.250</td> <td>M</td> </tr> <tr> <td>VM2035A0</td> <td>DRAIN PIPE SUPPORT</td> <td>2</td> <td>PZ</td> </tr> </tbody> </table>	Code	Description	Qty	UOM	VM1224A0	65MY 220MM 2 COLOURS SHRINK TUBE	0.250	M	VM2035A0	DRAIN PIPE SUPPORT	2	PZ								
Code	Description	Qty	UOM																						
VM1224A0	65MY 220MM 2 COLOURS SHRINK TUBE	0.250	M																						
VM2035A0	DRAIN PIPE SUPPORT	2	PZ																						



COMPONENT			SPARE PART																										
Code	Description	Image	Code	Description	Components list																								
VM1505A	WALL PASSING WITH DIAPHRAGM		KVM1505A	THROUGH-WALL CONNECTION+DIAPHRAGM KIT	<table border="1"> <thead> <tr> <th>Code</th> <th>Description</th> <th>Qty</th> <th>UOM</th> </tr> </thead> <tbody> <tr> <td>VH1220A1</td> <td>4,2X12 TCB SELF-TAPPING SCREW</td> <td>1</td> <td>PZ</td> </tr> <tr> <td>VM1224A0</td> <td>65MY 220MM 2 COLOURS SHRINK TUBE</td> <td>0.200</td> <td>M</td> </tr> <tr> <td>VM1505A0</td> <td>WALL PASSING WITH DIAPHRAGM</td> <td>3</td> <td>PZ</td> </tr> <tr> <td>VM2055A0</td> <td>UPPER WALL PASSING ACCESSORY CABLES</td> <td>1</td> <td>PZ</td> </tr> <tr> <td>VM2056A0</td> <td>LOWER WALL PASSING ACCESSORY CABLES</td> <td>1</td> <td>PZ</td> </tr> </tbody> </table>	Code	Description	Qty	UOM	VH1220A1	4,2X12 TCB SELF-TAPPING SCREW	1	PZ	VM1224A0	65MY 220MM 2 COLOURS SHRINK TUBE	0.200	M	VM1505A0	WALL PASSING WITH DIAPHRAGM	3	PZ	VM2055A0	UPPER WALL PASSING ACCESSORY CABLES	1	PZ	VM2056A0	LOWER WALL PASSING ACCESSORY CABLES	1	PZ
Code	Description	Qty	UOM																										
VH1220A1	4,2X12 TCB SELF-TAPPING SCREW	1	PZ																										
VM1224A0	65MY 220MM 2 COLOURS SHRINK TUBE	0.200	M																										
VM1505A0	WALL PASSING WITH DIAPHRAGM	3	PZ																										
VM2055A0	UPPER WALL PASSING ACCESSORY CABLES	1	PZ																										
VM2056A0	LOWER WALL PASSING ACCESSORY CABLES	1	PZ																										
VM1975A	DOOR SUPPORT LOWER BRACKET		KVM1975A	CL BL DOOR LOWER BRACKET KIT	<table border="1"> <thead> <tr> <th>Code</th> <th>Description</th> <th>Qty</th> <th>UOM</th> </tr> </thead> <tbody> <tr> <td>VM1224A0</td> <td>65MY 220MM 2 COLOURS SHRINK TUBE</td> <td>0.250</td> <td>M</td> </tr> <tr> <td>VM1975A0</td> <td>DOOR SUPPORT LOWER BRACKET</td> <td>1</td> <td>PZ</td> </tr> </tbody> </table>	Code	Description	Qty	UOM	VM1224A0	65MY 220MM 2 COLOURS SHRINK TUBE	0.250	M	VM1975A0	DOOR SUPPORT LOWER BRACKET	1	PZ												
Code	Description	Qty	UOM																										
VM1224A0	65MY 220MM 2 COLOURS SHRINK TUBE	0.250	M																										
VM1975A0	DOOR SUPPORT LOWER BRACKET	1	PZ																										
VM1974A	CONTROL PANEL CLOSING PLATE		VM1974A0	CONTROL PANEL CLOSING PLATE																									
VM2028A	20X10X4 RUBBER WASHER		KVM2028A	20X10X4 RUBBER WASHER 5 PCS. KIT	<table border="1"> <thead> <tr> <th>Code</th> <th>Description</th> <th>Qty</th> <th>UOM</th> </tr> </thead> <tbody> <tr> <td>VM1224A0</td> <td>65MY 220MM 2 COLOURS SHRINK TUBE</td> <td>0.200</td> <td>M</td> </tr> <tr> <td>VM2028A0</td> <td>20X10X4 RUBBER WASHER</td> <td>5</td> <td>PZ</td> </tr> </tbody> </table>	Code	Description	Qty	UOM	VM1224A0	65MY 220MM 2 COLOURS SHRINK TUBE	0.200	M	VM2028A0	20X10X4 RUBBER WASHER	5	PZ												
Code	Description	Qty	UOM																										
VM1224A0	65MY 220MM 2 COLOURS SHRINK TUBE	0.200	M																										
VM2028A0	20X10X4 RUBBER WASHER	5	PZ																										



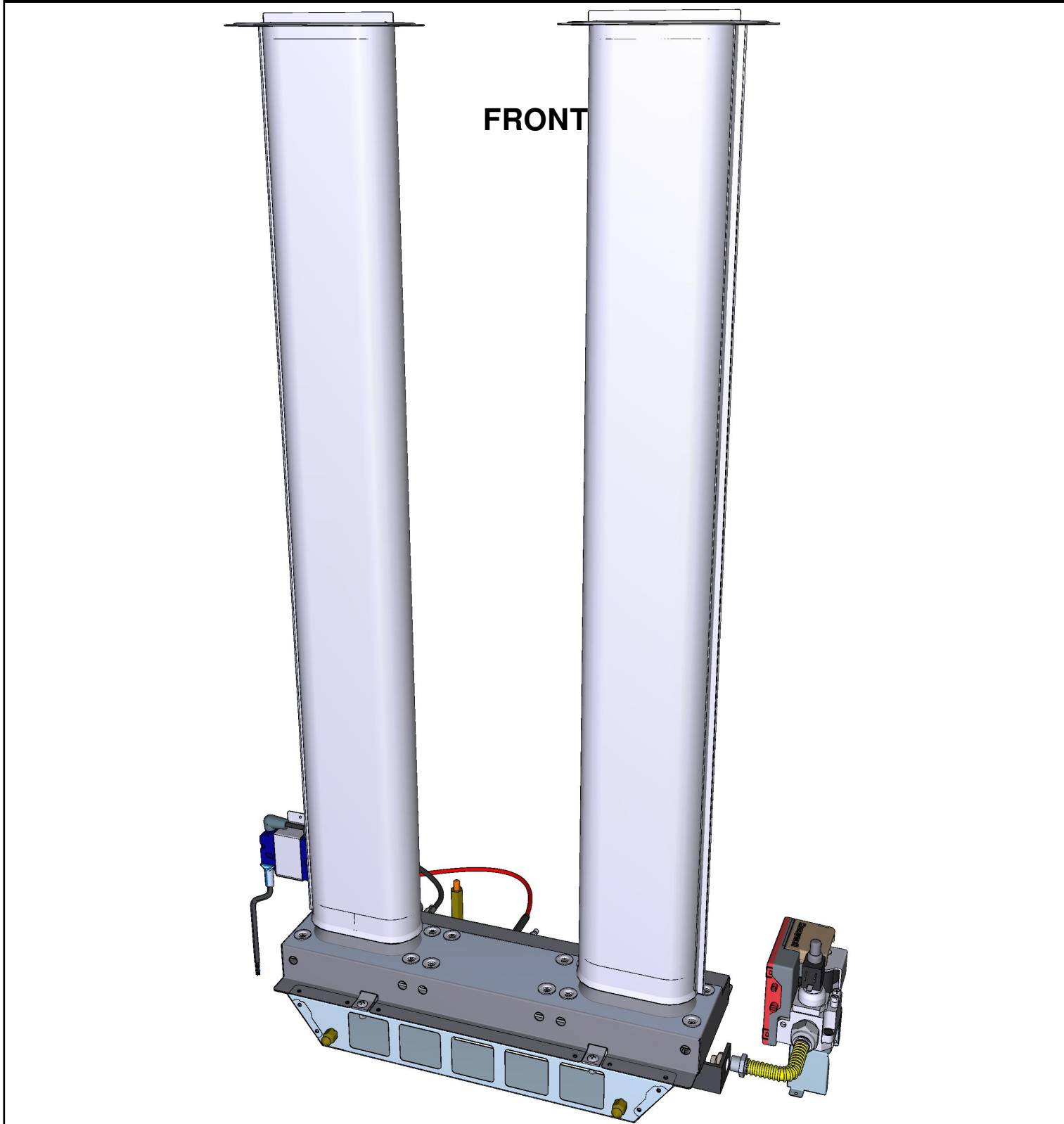

**ASM2794A/0.D00 - General overview**





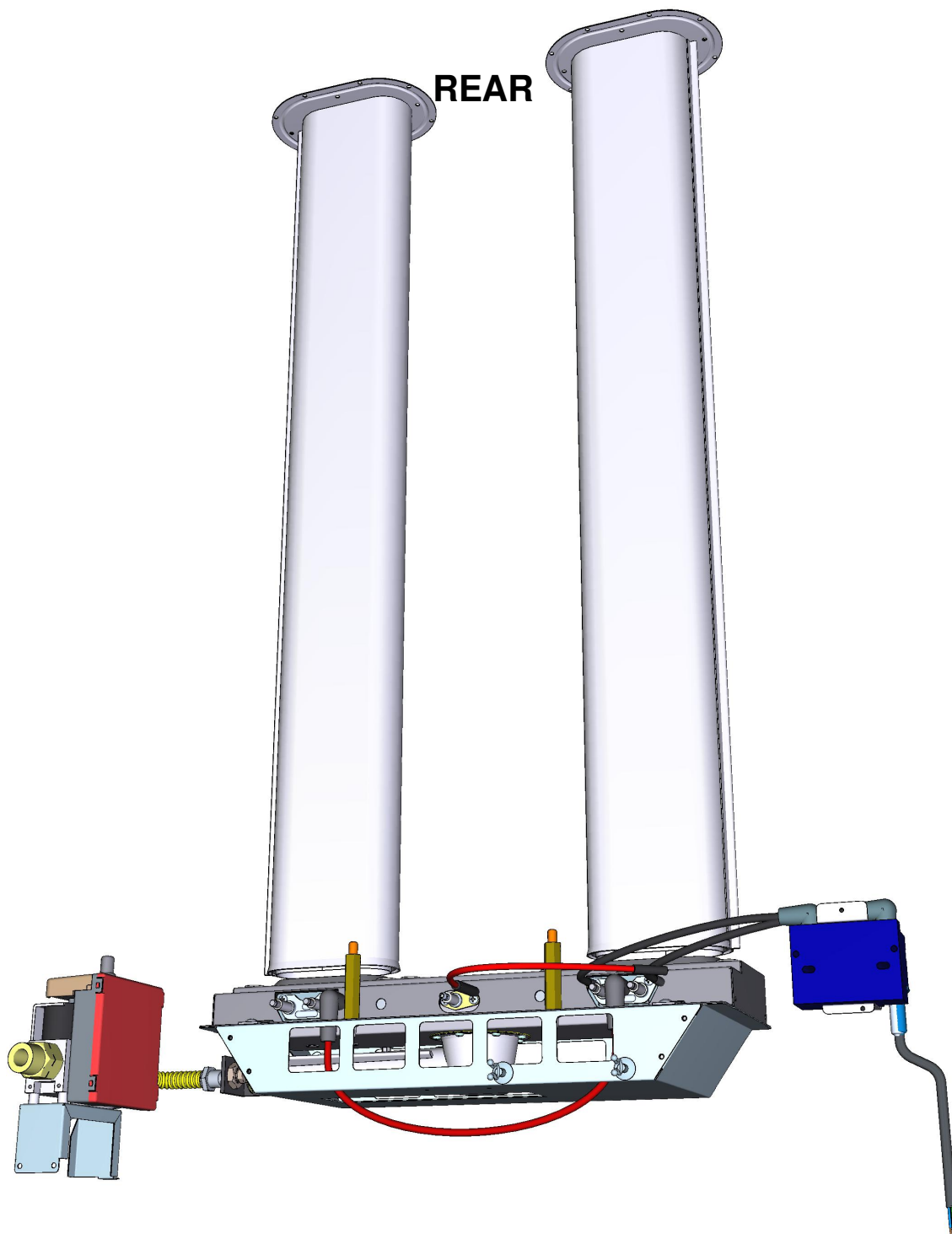

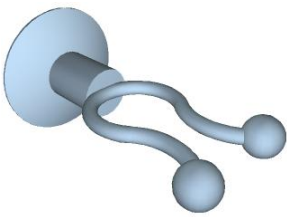
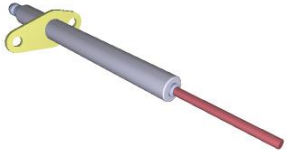

**ASM2794A/0.D00 - General overview**

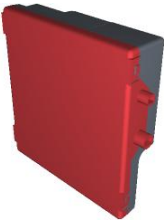

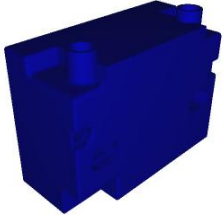

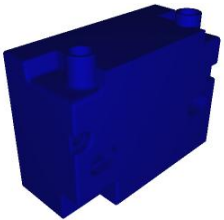

COMPONENT			SPARE PART																																		
Code	Description	Image	Code	Description	Components list																																
VM1610A	CLIP TWIST LOCK DIAM. 7,6-10,2 MM		VM1605A0	CLIP TWIST LOCK DIAM. 10,2-12,7 MM																																	
BR1230A	START UP SENSOR CANDLE		KBR1230A	XG SERIES SPARK DETECTION CANDLE KIT	<table border="1"> <thead> <tr> <th>Code</th> <th>Description</th> <th>Qty</th> <th>UOM</th> </tr> </thead> <tbody> <tr> <td>BR1230A0</td> <td>START UP SENSOR CANDLE</td> <td>1</td> <td>PZ</td> </tr> </tbody> </table>	Code	Description	Qty	UOM	BR1230A0	START UP SENSOR CANDLE	1	PZ																								
Code	Description	Qty	UOM																																		
BR1230A0	START UP SENSOR CANDLE	1	PZ																																		
BR1310A	XBC-XVC DOUBLE START UP CANDLE		KBR1310A	XBC-XVC DOUBLE START UP CANDLE 2PCS. KIT	<table border="1"> <thead> <tr> <th>Code</th> <th>Description</th> <th>Qty</th> <th>UOM</th> </tr> </thead> <tbody> <tr> <td>BR1310A0</td> <td>XBC-XVC DOUBLE START UP CANDLE</td> <td>2</td> <td>PZ</td> </tr> </tbody> </table>	Code	Description	Qty	UOM	BR1310A0	XBC-XVC DOUBLE START UP CANDLE	2	PZ																								
Code	Description	Qty	UOM																																		
BR1310A0	XBC-XVC DOUBLE START UP CANDLE	2	PZ																																		
EL1414A	TWO-STAGE GAS SOLENOID VALVE		KEL1414A	BISTABLE GAS VALVE KIT	<table border="1"> <thead> <tr> <th>Code</th> <th>Description</th> <th>Qty</th> <th>UOM</th> </tr> </thead> <tbody> <tr> <td>EL1414A0</td> <td>TWO-STAGE GAS SOLENOID VALVE</td> <td>1</td> <td>PZ</td> </tr> <tr> <td>RC1045A1</td> <td>3/4 FEMALE-3/4 STRAIGHT GAS FITTING</td> <td>1</td> <td>PZ</td> </tr> <tr> <td>RC1045A2</td> <td>"3/4" FEM.-3/4" MALE THREADED STRAIGHT</td> <td>1</td> <td>PZ</td> </tr> <tr> <td>RC1325A1</td> <td>FLEXIBLE GAS JOINT 3/8 EST-M13X1</td> <td>1</td> <td>PZ</td> </tr> <tr> <td>RC1325B0</td> <td></td> <td>1</td> <td>PZ</td> </tr> <tr> <td>VI1130A0</td> <td>ALUMINIUM BUSHING 24X18X1,5 TO HOLD GAS</td> <td>2</td> <td>PZ</td> </tr> <tr> <td>VM2147A0</td> <td>410X343X15 MM PINK SMOOTH ESD SPONGE</td> <td>1</td> <td>PZ</td> </tr> </tbody> </table>	Code	Description	Qty	UOM	EL1414A0	TWO-STAGE GAS SOLENOID VALVE	1	PZ	RC1045A1	3/4 FEMALE-3/4 STRAIGHT GAS FITTING	1	PZ	RC1045A2	"3/4" FEM.-3/4" MALE THREADED STRAIGHT	1	PZ	RC1325A1	FLEXIBLE GAS JOINT 3/8 EST-M13X1	1	PZ	RC1325B0		1	PZ	VI1130A0	ALUMINIUM BUSHING 24X18X1,5 TO HOLD GAS	2	PZ	VM2147A0	410X343X15 MM PINK SMOOTH ESD SPONGE	1	PZ
Code	Description	Qty	UOM																																		
EL1414A0	TWO-STAGE GAS SOLENOID VALVE	1	PZ																																		
RC1045A1	3/4 FEMALE-3/4 STRAIGHT GAS FITTING	1	PZ																																		
RC1045A2	"3/4" FEM.-3/4" MALE THREADED STRAIGHT	1	PZ																																		
RC1325A1	FLEXIBLE GAS JOINT 3/8 EST-M13X1	1	PZ																																		
RC1325B0		1	PZ																																		
VI1130A0	ALUMINIUM BUSHING 24X18X1,5 TO HOLD GAS	2	PZ																																		
VM2147A0	410X343X15 MM PINK SMOOTH ESD SPONGE	1	PZ																																		

COMPONENT			SPARE PART																																						
Code	Description	Image	Code	Description	Components list																																				
VE1055A	HLL 220-240V 5 SEC IGNITION BOX		KVE1055A	KIT FLAME CONTROL HLL 220-240V 50/60H	<table border="1"> <thead> <tr> <th>Code</th> <th>Description</th> <th>Qty</th> <th>UOM</th> </tr> </thead> <tbody> <tr> <td>VE1055A1</td> <td>HLL 220-240V 5 SEC IGNITION BOX</td> <td>1</td> <td>PZ</td> </tr> <tr> <td>VE1060A0</td> <td>COVER FOR VE1055A0</td> <td>1</td> <td>PZ</td> </tr> </tbody> </table>	Code	Description	Qty	UOM	VE1055A1	HLL 220-240V 5 SEC IGNITION BOX	1	PZ	VE1060A0	COVER FOR VE1055A0	1	PZ																								
Code	Description	Qty	UOM																																						
VE1055A1	HLL 220-240V 5 SEC IGNITION BOX	1	PZ																																						
VE1060A0	COVER FOR VE1055A0	1	PZ																																						
VE1060A	COVER FOR VE1055A0		KVE1060A		<table border="1"> <thead> <tr> <th>Code</th> <th>Description</th> <th>Qty</th> <th>UOM</th> </tr> </thead> <tbody> <tr> <td>VE1060A0</td> <td>COVER FOR VE1055A0</td> <td>1</td> <td>PZ</td> </tr> </tbody> </table>	Code	Description	Qty	UOM	VE1060A0	COVER FOR VE1055A0	1	PZ																												
Code	Description	Qty	UOM																																						
VE1060A0	COVER FOR VE1055A0	1	PZ																																						
0H6572B	CHEF-BAKERLUX GAS VALVE SUPPORT		0H6572B0	CHEF-BAKERLUX GAS VALVE SUPPORT																																					
VE1625A	5E- MM SERIES FIDA GAS LIGHTER		KVE0009B	EUROPE VERSION GAS IGNITER KIT	<table border="1"> <thead> <tr> <th>Code</th> <th>Description</th> <th>Qty</th> <th>UOM</th> </tr> </thead> <tbody> <tr> <td>0H5126A0</td> <td>IGNITER FIXING OMEG</td> <td>1</td> <td>PZ</td> </tr> <tr> <td>0H6825A0</td> <td>METAL CLAMP</td> <td>1</td> <td>PZ</td> </tr> <tr> <td>CE1390A0</td> <td>YELLOW CABLE UNIP RUBB.SIL. Ø 0.75 MMQ</td> <td>0.260</td> <td>M</td> </tr> <tr> <td>CE1395A0</td> <td>6,3 X 0,8 ♂MALE FASTO</td> <td>4</td> <td>PZ</td> </tr> <tr> <td>CE1661A0</td> <td>MALE FASTON COVER 6,3X0,</td> <td>4</td> <td>PZ</td> </tr> <tr> <td>CE1777A1</td> <td>HV START UP CABLE L=700 WITH SILICON CAP</td> <td>2</td> <td>PZ</td> </tr> <tr> <td>CE1782A0</td> <td>HV L=300 BRIDGE FIDA CABLE</td> <td>1</td> <td>PZ</td> </tr> <tr> <td>CE1792A0</td> <td>FLAME DETECTOR CANDLE CABL</td> <td>1</td> <td>PZ</td> </tr> </tbody> </table>	Code	Description	Qty	UOM	0H5126A0	IGNITER FIXING OMEG	1	PZ	0H6825A0	METAL CLAMP	1	PZ	CE1390A0	YELLOW CABLE UNIP RUBB.SIL. Ø 0.75 MMQ	0.260	M	CE1395A0	6,3 X 0,8 ♂MALE FASTO	4	PZ	CE1661A0	MALE FASTON COVER 6,3X0,	4	PZ	CE1777A1	HV START UP CABLE L=700 WITH SILICON CAP	2	PZ	CE1782A0	HV L=300 BRIDGE FIDA CABLE	1	PZ	CE1792A0	FLAME DETECTOR CANDLE CABL	1	PZ
Code	Description	Qty	UOM																																						
0H5126A0	IGNITER FIXING OMEG	1	PZ																																						
0H6825A0	METAL CLAMP	1	PZ																																						
CE1390A0	YELLOW CABLE UNIP RUBB.SIL. Ø 0.75 MMQ	0.260	M																																						
CE1395A0	6,3 X 0,8 ♂MALE FASTO	4	PZ																																						
CE1661A0	MALE FASTON COVER 6,3X0,	4	PZ																																						
CE1777A1	HV START UP CABLE L=700 WITH SILICON CAP	2	PZ																																						
CE1782A0	HV L=300 BRIDGE FIDA CABLE	1	PZ																																						
CE1792A0	FLAME DETECTOR CANDLE CABL	1	PZ																																						

COMPONENT			SPARE PART																																						
Code	Description	Image	Code	Description	Components list																																				
VE1625A	5E- MM SERIES FIDA GAS LIGHTER		KVE0009B	EUROPE VERSION GAS IGNITER KIT	<table border="1"> <thead> <tr> <th>Code</th> <th>Description</th> <th>Qty</th> <th>UOM</th> </tr> </thead> <tbody> <tr> <td>CE1811A1</td> <td>LIGHTER CONNECTING CABLE PLUG 90°</td> <td>1</td> <td>PZ</td> </tr> <tr> <td>GN1328A1</td> <td>BACK BLACK ADESIVE GASKET 8X3</td> <td>0.500</td> <td>M</td> </tr> <tr> <td>VE1625A0</td> <td>5E- MM SERIES FIDA GAS LIGHTER</td> <td>1</td> <td>PZ</td> </tr> <tr> <td>VI1220A1</td> <td>4,2X12 TCB SELF-TAPPIN G SCREW</td> <td>2</td> <td>PZ</td> </tr> <tr> <td>VI1950A0</td> <td>ST. STEEL 4,2X13 TCB SELF-DRILLIN G SCREW</td> <td>1</td> <td>PZ</td> </tr> <tr> <td>VM1255A1</td> <td>THREAD-COV ERING CAP MARUTEX</td> <td>1</td> <td>PZ</td> </tr> </tbody> </table>	Code	Description	Qty	UOM	CE1811A1	LIGHTER CONNECTING CABLE PLUG 90°	1	PZ	GN1328A1	BACK BLACK ADESIVE GASKET 8X3	0.500	M	VE1625A0	5E- MM SERIES FIDA GAS LIGHTER	1	PZ	VI1220A1	4,2X12 TCB SELF-TAPPIN G SCREW	2	PZ	VI1950A0	ST. STEEL 4,2X13 TCB SELF-DRILLIN G SCREW	1	PZ	VM1255A1	THREAD-COV ERING CAP MARUTEX	1	PZ								
					Code	Description	Qty	UOM																																	
					CE1811A1	LIGHTER CONNECTING CABLE PLUG 90°	1	PZ																																	
					GN1328A1	BACK BLACK ADESIVE GASKET 8X3	0.500	M																																	
					VE1625A0	5E- MM SERIES FIDA GAS LIGHTER	1	PZ																																	
					VI1220A1	4,2X12 TCB SELF-TAPPIN G SCREW	2	PZ																																	
					VI1950A0	ST. STEEL 4,2X13 TCB SELF-DRILLIN G SCREW	1	PZ																																	
VM1255A1	THREAD-COV ERING CAP MARUTEX	1	PZ																																						
0H5126A	IGNITER FIXING OMEGA		0H5126A0	IGNITER FIXING OMEGA																																					
CE1777A	HV START UP CABLE L=700 WITH SILICON CAP		KVE0013A	AUSTRALIAN VERSION GAS IGNITER KIT	<table border="1"> <thead> <tr> <th>Code</th> <th>Description</th> <th>Qty</th> <th>UOM</th> </tr> </thead> <tbody> <tr> <td>0H5126A0</td> <td>IGNITER FIXING OMEG</td> <td>1</td> <td>PZ</td> </tr> <tr> <td>CE1777A1</td> <td>HV START UP CABLE L=700 WITH SILICON CAP</td> <td>2</td> <td>PZ</td> </tr> <tr> <td>CE1782A0</td> <td>HV L=300 BRIDGE FIDA CABLE</td> <td>1</td> <td>PZ</td> </tr> <tr> <td>CE1789A0</td> <td>LIGHTER POWER SUPPLY FIDA CABLE</td> <td>1</td> <td>PZ</td> </tr> <tr> <td>CE1792A0</td> <td>FLAME DETECTOR CANDLE CABL</td> <td>1</td> <td>PZ</td> </tr> <tr> <td>GN1328A1</td> <td>BACK BLACK ADESIVE GASKET 8X3</td> <td>0.500</td> <td>M</td> </tr> <tr> <td>VE1621A0</td> <td>FIDA LIGHTER</td> <td>1</td> <td>PZ</td> </tr> <tr> <td>VI1220A1</td> <td>4,2X12 TCB SELF-TAPPIN G SCREW</td> <td>2</td> <td>PZ</td> </tr> </tbody> </table>	Code	Description	Qty	UOM	0H5126A0	IGNITER FIXING OMEG	1	PZ	CE1777A1	HV START UP CABLE L=700 WITH SILICON CAP	2	PZ	CE1782A0	HV L=300 BRIDGE FIDA CABLE	1	PZ	CE1789A0	LIGHTER POWER SUPPLY FIDA CABLE	1	PZ	CE1792A0	FLAME DETECTOR CANDLE CABL	1	PZ	GN1328A1	BACK BLACK ADESIVE GASKET 8X3	0.500	M	VE1621A0	FIDA LIGHTER	1	PZ	VI1220A1	4,2X12 TCB SELF-TAPPIN G SCREW	2	PZ
					Code	Description	Qty	UOM																																	
					0H5126A0	IGNITER FIXING OMEG	1	PZ																																	
					CE1777A1	HV START UP CABLE L=700 WITH SILICON CAP	2	PZ																																	
					CE1782A0	HV L=300 BRIDGE FIDA CABLE	1	PZ																																	
					CE1789A0	LIGHTER POWER SUPPLY FIDA CABLE	1	PZ																																	
					CE1792A0	FLAME DETECTOR CANDLE CABL	1	PZ																																	
					GN1328A1	BACK BLACK ADESIVE GASKET 8X3	0.500	M																																	
					VE1621A0	FIDA LIGHTER	1	PZ																																	
					VI1220A1	4,2X12 TCB SELF-TAPPIN G SCREW	2	PZ																																	



COMPONENT			SPARE PART																																											
Code	Description	Image	Code	Description	Components list																																									
CE1777A	HV START UP CABLE L=700 WITH SILICON CAP		KVE0010A	USA VERSION GAS IGNITER KIT	<table border="1"> <thead> <tr> <th>Code</th> <th>Description</th> <th>Qty</th> <th>UOM</th> </tr> </thead> <tbody> <tr> <td>0H7457A1</td> <td>SHIELD- META</td> <td>1</td> <td>PZ</td> </tr> <tr> <td>CE1056A0</td> <td>IC POWER CABLE UNIT GAS USA MM</td> <td>2</td> <td>PZ</td> </tr> <tr> <td>CE1057B0</td> <td>MM USA GAS-IGNITER CONTROL EV CABLE</td> <td>2</td> <td>PZ</td> </tr> <tr> <td>CE1059A1</td> <td>3P-6.35MM FLAME DETECTOR 10KV CABLE</td> <td>2</td> <td>PZ</td> </tr> <tr> <td>CE1777A1</td> <td>HV START UP CABLE L=700 WITH SILICON CAP</td> <td>4</td> <td>PZ</td> </tr> <tr> <td>GN1328A1</td> <td>BACK BLACK ADESIVE GASKET 8X3</td> <td>0.500</td> <td>M</td> </tr> <tr> <td>VE1637A0</td> <td>FLAME CONTROL BOARD</td> <td>2</td> <td>PZ</td> </tr> <tr> <td>VI1220A1</td> <td>4,2X12 TCB SELF-TAPPIN G SCREW</td> <td>4</td> <td>PZ</td> </tr> </tbody> </table>	Code	Description	Qty	UOM	0H7457A1	SHIELD- META	1	PZ	CE1056A0	IC POWER CABLE UNIT GAS USA MM	2	PZ	CE1057B0	MM USA GAS-IGNITER CONTROL EV CABLE	2	PZ	CE1059A1	3P-6.35MM FLAME DETECTOR 10KV CABLE	2	PZ	CE1777A1	HV START UP CABLE L=700 WITH SILICON CAP	4	PZ	GN1328A1	BACK BLACK ADESIVE GASKET 8X3	0.500	M	VE1637A0	FLAME CONTROL BOARD	2	PZ	VI1220A1	4,2X12 TCB SELF-TAPPIN G SCREW	4	PZ					
			Code	Description	Qty	UOM																																								
0H7457A1	SHIELD- META	1	PZ																																											
CE1056A0	IC POWER CABLE UNIT GAS USA MM	2	PZ																																											
CE1057B0	MM USA GAS-IGNITER CONTROL EV CABLE	2	PZ																																											
CE1059A1	3P-6.35MM FLAME DETECTOR 10KV CABLE	2	PZ																																											
CE1777A1	HV START UP CABLE L=700 WITH SILICON CAP	4	PZ																																											
GN1328A1	BACK BLACK ADESIVE GASKET 8X3	0.500	M																																											
VE1637A0	FLAME CONTROL BOARD	2	PZ																																											
VI1220A1	4,2X12 TCB SELF-TAPPIN G SCREW	4	PZ																																											
KVE0009B	EUROPE VERSION GAS IGNITER KIT	<table border="1"> <thead> <tr> <th>Code</th> <th>Description</th> <th>Qty</th> <th>UOM</th> </tr> </thead> <tbody> <tr> <td>0H5126A0</td> <td>IGNITER FIXING OMEG</td> <td>1</td> <td>PZ</td> </tr> <tr> <td>0H6825A0</td> <td>METAL CLAMP</td> <td>1</td> <td>PZ</td> </tr> <tr> <td>CE1390A0</td> <td>YELLOW CABLE UNIP RUBB.SIL. Ø 0,75 MMQ</td> <td>0.260</td> <td>M</td> </tr> <tr> <td>CE1395A0</td> <td>6,3 X 0,8 IMALE FASTO</td> <td>4</td> <td>PZ</td> </tr> <tr> <td>CE1661A0</td> <td>MALE FASTON COVER 6,3X0,</td> <td>4</td> <td>PZ</td> </tr> <tr> <td>CE1777A1</td> <td>HV START UP CABLE L=700 WITH SILICON CAP</td> <td>2</td> <td>PZ</td> </tr> <tr> <td>CE1782A0</td> <td>HV L=300 BRIDGE FIDA CABLE</td> <td>1</td> <td>PZ</td> </tr> <tr> <td>CE1792A0</td> <td>FLAME DETECTOR CANDLE CABL</td> <td>1</td> <td>PZ</td> </tr> <tr> <td>CE1811A1</td> <td>LIGHTER CONNECTING CABLE PLUG 90°</td> <td>1</td> <td>PZ</td> </tr> <tr> <td>GN1328A1</td> <td>BACK BLACK ADESIVE GASKET 8X3</td> <td>0.500</td> <td>M</td> </tr> </tbody> </table>	Code	Description	Qty	UOM	0H5126A0	IGNITER FIXING OMEG	1	PZ	0H6825A0	METAL CLAMP	1	PZ	CE1390A0	YELLOW CABLE UNIP RUBB.SIL. Ø 0,75 MMQ	0.260	M	CE1395A0	6,3 X 0,8 IMALE FASTO	4	PZ	CE1661A0	MALE FASTON COVER 6,3X0,	4	PZ	CE1777A1	HV START UP CABLE L=700 WITH SILICON CAP	2	PZ	CE1782A0	HV L=300 BRIDGE FIDA CABLE	1	PZ	CE1792A0	FLAME DETECTOR CANDLE CABL	1	PZ	CE1811A1	LIGHTER CONNECTING CABLE PLUG 90°	1	PZ	GN1328A1	BACK BLACK ADESIVE GASKET 8X3	0.500	M
Code	Description	Qty	UOM																																											
0H5126A0	IGNITER FIXING OMEG	1	PZ																																											
0H6825A0	METAL CLAMP	1	PZ																																											
CE1390A0	YELLOW CABLE UNIP RUBB.SIL. Ø 0,75 MMQ	0.260	M																																											
CE1395A0	6,3 X 0,8 IMALE FASTO	4	PZ																																											
CE1661A0	MALE FASTON COVER 6,3X0,	4	PZ																																											
CE1777A1	HV START UP CABLE L=700 WITH SILICON CAP	2	PZ																																											
CE1782A0	HV L=300 BRIDGE FIDA CABLE	1	PZ																																											
CE1792A0	FLAME DETECTOR CANDLE CABL	1	PZ																																											
CE1811A1	LIGHTER CONNECTING CABLE PLUG 90°	1	PZ																																											
GN1328A1	BACK BLACK ADESIVE GASKET 8X3	0.500	M																																											

COMPONENT			SPARE PART																						
Code	Description	Image	Code	Description	Components list																				
CE1777A	HV START UP CABLE L=700 WITH SILICON CAP		KVE0009B	EUROPE VERSION GAS IGNITER KIT	<table border="1"> <thead> <tr> <th>Code</th> <th>Description</th> <th>Qty</th> <th>UOM</th> </tr> </thead> <tbody> <tr> <td>VE1625A0</td> <td>5E- MM SERIES FIDA GAS LIGHTER</td> <td>1</td> <td>PZ</td> </tr> <tr> <td>VI1220A1</td> <td>4,2X12 TCB SELF-TAPPIN G SCREW</td> <td>2</td> <td>PZ</td> </tr> <tr> <td>VI1950A0</td> <td>ST. STEEL 4,2X13 TCB SELF-DRILLIN G SCREW</td> <td>1</td> <td>PZ</td> </tr> <tr> <td>VM1255A1</td> <td>THREAD-COV ERING CAP MARUTEX</td> <td>1</td> <td>PZ</td> </tr> </tbody> </table>	Code	Description	Qty	UOM	VE1625A0	5E- MM SERIES FIDA GAS LIGHTER	1	PZ	VI1220A1	4,2X12 TCB SELF-TAPPIN G SCREW	2	PZ	VI1950A0	ST. STEEL 4,2X13 TCB SELF-DRILLIN G SCREW	1	PZ	VM1255A1	THREAD-COV ERING CAP MARUTEX	1	PZ
			Code	Description	Qty	UOM																			
VE1625A0	5E- MM SERIES FIDA GAS LIGHTER	1	PZ																						
VI1220A1	4,2X12 TCB SELF-TAPPIN G SCREW	2	PZ																						
VI1950A0	ST. STEEL 4,2X13 TCB SELF-DRILLIN G SCREW	1	PZ																						
VM1255A1	THREAD-COV ERING CAP MARUTEX	1	PZ																						
KCE1777A	EUROPE VERSION HV START UP CABLES KIT	<table border="1"> <thead> <tr> <th>Code</th> <th>Description</th> <th>Qty</th> <th>UOM</th> </tr> </thead> <tbody> <tr> <td>CE1777A1</td> <td>HV START UP CABLE L=700 WITH SILICON CAP</td> <td>2</td> <td>PZ</td> </tr> <tr> <td>CE1782A0</td> <td>HV L=300 BRIDGE FIDA CABLE</td> <td>1</td> <td>PZ</td> </tr> <tr> <td>VM1224A0</td> <td>65MY 220MM 2 COLOURS SHRINK TUBE</td> <td>0.350</td> <td>M</td> </tr> </tbody> </table>	Code	Description	Qty	UOM	CE1777A1	HV START UP CABLE L=700 WITH SILICON CAP	2	PZ	CE1782A0	HV L=300 BRIDGE FIDA CABLE	1	PZ	VM1224A0	65MY 220MM 2 COLOURS SHRINK TUBE	0.350	M							
Code	Description	Qty	UOM																						
CE1777A1	HV START UP CABLE L=700 WITH SILICON CAP	2	PZ																						
CE1782A0	HV L=300 BRIDGE FIDA CABLE	1	PZ																						
VM1224A0	65MY 220MM 2 COLOURS SHRINK TUBE	0.350	M																						
0N1135A	GAS BAFFLE FORK		0N1135A2	GAS BAFFLE FORK																					
0N1235A	XBC814G BAFFLE		0N1235A0	XBC814G BAFFLE																					



**ASM4101A/0.D01 - General overview**

**FRONT**

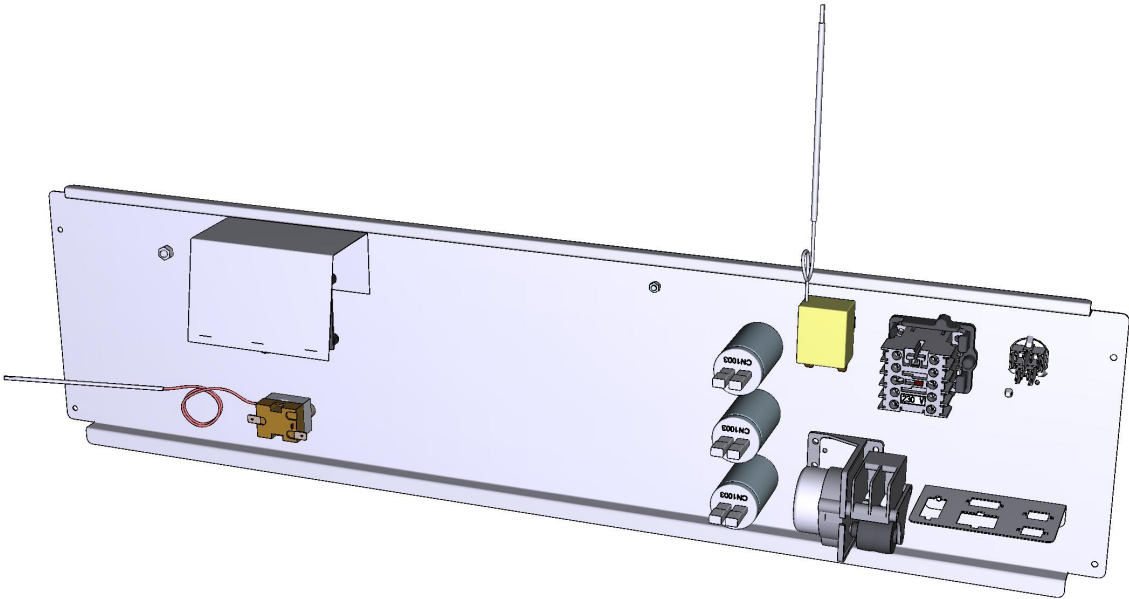





**ASM4101A/0.D01 - General overview**

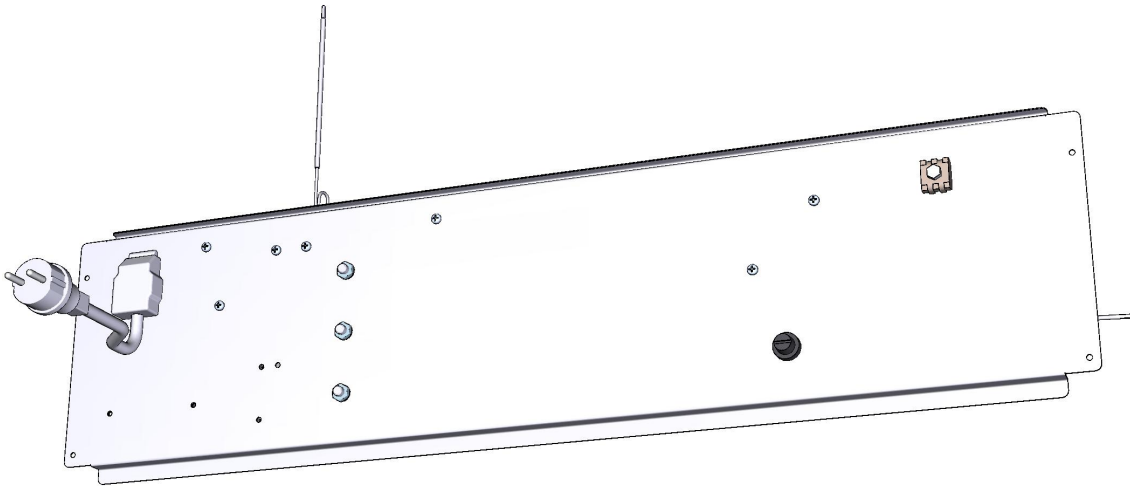

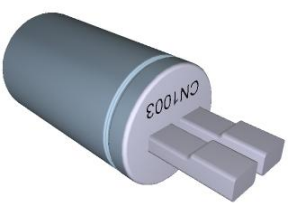
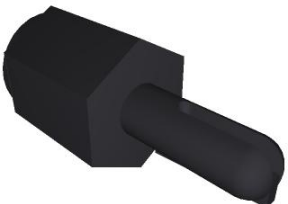
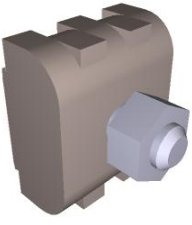
**REAR**

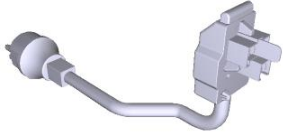
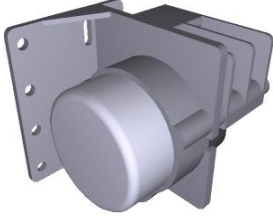
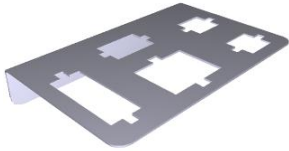

COMPONENT			SPARE PART																																		
Code	Description	Image	Code	Description	Components list																																
TR1136A	330°C 1 POLE SAFETY THERMOSTAT		KTR1136A	330°C SAFETY THERMOSTAT KIT	<table border="1"> <thead> <tr> <th>Code</th> <th>Description</th> <th>Qty</th> <th>UOM</th> </tr> </thead> <tbody> <tr> <td>0H7030A0</td> <td>THERMOSTAT BULB INLET COVER</td> <td>1</td> <td>PZ</td> </tr> <tr> <td>GN1531A0</td> <td>THERMOSTAT BULB INLET SEALING</td> <td>1</td> <td>PZ</td> </tr> <tr> <td>MOV0011A0</td> <td>HOOD RING GASKET</td> <td>0.100</td> <td>PZ</td> </tr> <tr> <td>GN1110A2</td> <td></td> <td></td> <td></td> </tr> <tr> <td>SL1045A0</td> <td>S57 BLACK SILICONE - 80ML CARTRIDGE</td> <td>1</td> <td>PZ</td> </tr> <tr> <td>TR1136A0</td> <td>330°C 1 POLE SAFETY THERMOSTAT</td> <td>1</td> <td>PZ</td> </tr> <tr> <td>VI1220A1</td> <td>4,2X12 TCB SELF-TAPPING SCREW</td> <td>3</td> <td>PZ</td> </tr> </tbody> </table>	Code	Description	Qty	UOM	0H7030A0	THERMOSTAT BULB INLET COVER	1	PZ	GN1531A0	THERMOSTAT BULB INLET SEALING	1	PZ	MOV0011A0	HOOD RING GASKET	0.100	PZ	GN1110A2				SL1045A0	S57 BLACK SILICONE - 80ML CARTRIDGE	1	PZ	TR1136A0	330°C 1 POLE SAFETY THERMOSTAT	1	PZ	VI1220A1	4,2X12 TCB SELF-TAPPING SCREW	3	PZ
Code	Description	Qty	UOM																																		
0H7030A0	THERMOSTAT BULB INLET COVER	1	PZ																																		
GN1531A0	THERMOSTAT BULB INLET SEALING	1	PZ																																		
MOV0011A0	HOOD RING GASKET	0.100	PZ																																		
GN1110A2																																					
SL1045A0	S57 BLACK SILICONE - 80ML CARTRIDGE	1	PZ																																		
TR1136A0	330°C 1 POLE SAFETY THERMOSTAT	1	PZ																																		
VI1220A1	4,2X12 TCB SELF-TAPPING SCREW	3	PZ																																		
CN1003A	6,3 UF MOTOR CAPACITOR		KCN1003A	6,3 UF MOTOR CAPACITOR KIT	<table border="1"> <thead> <tr> <th>Code</th> <th>Description</th> <th>Qty</th> <th>UOM</th> </tr> </thead> <tbody> <tr> <td>CN1003A0</td> <td>6,3 UF MOTOR CAPACITOR</td> <td>1</td> <td>PZ</td> </tr> <tr> <td>VI1931A0</td> <td>M8 NUT+INDENTE D WASHER D=8 X COND.</td> <td>1</td> <td>PZ</td> </tr> <tr> <td>VI1932A0</td> <td>M8 NUT+INDENTE D WASHER D=8 X COND.</td> <td>1</td> <td>PZ</td> </tr> <tr> <td>VM1224A0</td> <td>65MY 220MM 2 COLOURS SHRINK TUBE</td> <td>0.200</td> <td>M</td> </tr> </tbody> </table>	Code	Description	Qty	UOM	CN1003A0	6,3 UF MOTOR CAPACITOR	1	PZ	VI1931A0	M8 NUT+INDENTE D WASHER D=8 X COND.	1	PZ	VI1932A0	M8 NUT+INDENTE D WASHER D=8 X COND.	1	PZ	VM1224A0	65MY 220MM 2 COLOURS SHRINK TUBE	0.200	M												
Code	Description	Qty	UOM																																		
CN1003A0	6,3 UF MOTOR CAPACITOR	1	PZ																																		
VI1931A0	M8 NUT+INDENTE D WASHER D=8 X COND.	1	PZ																																		
VI1932A0	M8 NUT+INDENTE D WASHER D=8 X COND.	1	PZ																																		
VM1224A0	65MY 220MM 2 COLOURS SHRINK TUBE	0.200	M																																		
VM1745A	CARD SUPPORT		KVM1745A	BOARD SUPPORT 10 PCS KIT	<table border="1"> <thead> <tr> <th>Code</th> <th>Description</th> <th>Qty</th> <th>UOM</th> </tr> </thead> <tbody> <tr> <td>VM1224A0</td> <td>65MY 220MM 2 COLOURS SHRINK TUBE</td> <td>0.200</td> <td>M</td> </tr> <tr> <td>VM1745A0</td> <td>CARD SUPPORT</td> <td>10</td> <td>PZ</td> </tr> </tbody> </table>	Code	Description	Qty	UOM	VM1224A0	65MY 220MM 2 COLOURS SHRINK TUBE	0.200	M	VM1745A0	CARD SUPPORT	10	PZ																				
Code	Description	Qty	UOM																																		
VM1224A0	65MY 220MM 2 COLOURS SHRINK TUBE	0.200	M																																		
VM1745A0	CARD SUPPORT	10	PZ																																		
VM1750A	BRASS COMB CLAM		KVM1750A	COMB TERMINAL BLOCK KIT	<table border="1"> <thead> <tr> <th>Code</th> <th>Description</th> <th>Qty</th> <th>UOM</th> </tr> </thead> <tbody> <tr> <td>VM1224A0</td> <td>65MY 220MM 2 COLOURS SHRINK TUBE</td> <td>0.150</td> <td>M</td> </tr> <tr> <td>VM1750A0</td> <td>BRASS COMB CLAMP</td> <td>1</td> <td>PZ</td> </tr> </tbody> </table>	Code	Description	Qty	UOM	VM1224A0	65MY 220MM 2 COLOURS SHRINK TUBE	0.150	M	VM1750A0	BRASS COMB CLAMP	1	PZ																				
Code	Description	Qty	UOM																																		
VM1224A0	65MY 220MM 2 COLOURS SHRINK TUBE	0.150	M																																		
VM1750A0	BRASS COMB CLAMP	1	PZ																																		

COMPONENT			SPARE PART																						
Code	Description	Image	Code	Description	Components list																				
MR1000A	CABLE 3X1,5 H07RN-F MT1,5+K2/3+SCHUK		KMR1000A	KIT CABLE 3X1,5 H07RN-F +K2/3+SCHUKO	<table border="1"> <thead> <tr> <th>Code</th> <th>Description</th> <th>Qty</th> <th>UOM</th> </tr> </thead> <tbody> <tr> <td>MR1000A0</td> <td>CABLE 3X1,5 H07RN-F MT1,5+K2/3+S CHUKO</td> <td>1</td> <td>PZ</td> </tr> <tr> <td>VM1224A0</td> <td>65MY 220MM 2 COLOURS SHRINK TUBE</td> <td>0.350</td> <td>M</td> </tr> </tbody> </table>	Code	Description	Qty	UOM	MR1000A0	CABLE 3X1,5 H07RN-F MT1,5+K2/3+S CHUKO	1	PZ	VM1224A0	65MY 220MM 2 COLOURS SHRINK TUBE	0.350	M								
Code	Description	Qty	UOM																						
MR1000A0	CABLE 3X1,5 H07RN-F MT1,5+K2/3+S CHUKO	1	PZ																						
VM1224A0	65MY 220MM 2 COLOURS SHRINK TUBE	0.350	M																						
VE1615A	MOTOR REVERSING SWITCH		KVE1615A	MOTOR REVERSING SWITCH KIT	<table border="1"> <thead> <tr> <th>Code</th> <th>Description</th> <th>Qty</th> <th>UOM</th> </tr> </thead> <tbody> <tr> <td>0H1429A0</td> <td>VE1615A INVERTER FIXING PLATE</td> <td>1</td> <td>PZ</td> </tr> <tr> <td>VE1615A0</td> <td>MOTOR REVERSING SWITCH</td> <td>1</td> <td>PZ</td> </tr> <tr> <td>VI1960A0</td> <td>SELF-TAPPIN G SCREW 4.2X11 TCBS+ AISI410</td> <td>3</td> <td>PZ</td> </tr> <tr> <td>VI1960A1</td> <td>4.2X9.5 CROSS ZN-NI SELF-THREADI NG SCREW</td> <td>3</td> <td>PZ</td> </tr> </tbody> </table>	Code	Description	Qty	UOM	0H1429A0	VE1615A INVERTER FIXING PLATE	1	PZ	VE1615A0	MOTOR REVERSING SWITCH	1	PZ	VI1960A0	SELF-TAPPIN G SCREW 4.2X11 TCBS+ AISI410	3	PZ	VI1960A1	4.2X9.5 CROSS ZN-NI SELF-THREADI NG SCREW	3	PZ
Code	Description	Qty	UOM																						
0H1429A0	VE1615A INVERTER FIXING PLATE	1	PZ																						
VE1615A0	MOTOR REVERSING SWITCH	1	PZ																						
VI1960A0	SELF-TAPPIN G SCREW 4.2X11 TCBS+ AISI410	3	PZ																						
VI1960A1	4.2X9.5 CROSS ZN-NI SELF-THREADI NG SCREW	3	PZ																						
0H6769A	CONNECTOR FIXING PANEL		0H6769B0																						
PE1782A	200-240VAC 12VCC 6VA POWER SUPPL		KPE1782A	LED BAR 200-240VAC 12VCC TRANSFORMER KIT	<table border="1"> <thead> <tr> <th>Code</th> <th>Description</th> <th>Qty</th> <th>UOM</th> </tr> </thead> <tbody> <tr> <td>PE1782A0</td> <td>200-240VAC 12VCC 6VA POWER SUPPLY</td> <td>1</td> <td>PZ</td> </tr> <tr> <td>VM1745A0</td> <td>CARD SUPPORT</td> <td>4</td> <td>PZ</td> </tr> <tr> <td>VM2147A0</td> <td>410X343X15 MM PINK SMOOTH ESD SPONGE</td> <td>1</td> <td>PZ</td> </tr> </tbody> </table>	Code	Description	Qty	UOM	PE1782A0	200-240VAC 12VCC 6VA POWER SUPPLY	1	PZ	VM1745A0	CARD SUPPORT	4	PZ	VM2147A0	410X343X15 MM PINK SMOOTH ESD SPONGE	1	PZ				
Code	Description	Qty	UOM																						
PE1782A0	200-240VAC 12VCC 6VA POWER SUPPLY	1	PZ																						
VM1745A0	CARD SUPPORT	4	PZ																						
VM2147A0	410X343X15 MM PINK SMOOTH ESD SPONGE	1	PZ																						

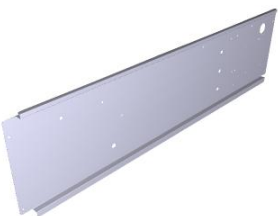

COMPONENT			SPARE PART																		
Code	Description	Image	Code	Description	Components list																
VE1115A	20 A 230V 4 POLES MINICONTACTOR		KVE1115A	20A 230V 4 POLES MINICONTACTOR KI	<table border="1"> <thead> <tr> <th>Code</th> <th>Description</th> <th>Qty</th> <th>UOM</th> </tr> </thead> <tbody> <tr> <td>VE1115A0</td> <td>20 A 230V 4 POLES MINICONTACT OR</td> <td>1</td> <td>PZ</td> </tr> <tr> <td>VM1075A1</td> <td>PLASTIC CLIP TO FIX CONTACTORS</td> <td>4</td> <td>PZ</td> </tr> <tr> <td>VM1224A0</td> <td>65MY 220MM 2 COLOURS SHRINK TUBE</td> <td>0.250</td> <td>M</td> </tr> </tbody> </table>	Code	Description	Qty	UOM	VE1115A0	20 A 230V 4 POLES MINICONTACT OR	1	PZ	VM1075A1	PLASTIC CLIP TO FIX CONTACTORS	4	PZ	VM1224A0	65MY 220MM 2 COLOURS SHRINK TUBE	0.250	M
Code	Description	Qty	UOM																		
VE1115A0	20 A 230V 4 POLES MINICONTACT OR	1	PZ																		
VM1075A1	PLASTIC CLIP TO FIX CONTACTORS	4	PZ																		
VM1224A0	65MY 220MM 2 COLOURS SHRINK TUBE	0.250	M																		
VM1056A	SMALL CONTACTOR BRACKET VE1115A		VM1056A0	SMALL CONTACTOR BRACKET VE1115A																	
TR1142A	EXHAUST FUMES THERMOSTAT		KTR1142A	EXHAUST FUMES THERMOSTAT KIT	<table border="1"> <thead> <tr> <th>Code</th> <th>Description</th> <th>Qty</th> <th>UOM</th> </tr> </thead> <tbody> <tr> <td>TR1142A0</td> <td>EXHAUST FUMES THERMOSTAT</td> <td>1</td> <td>PZ</td> </tr> </tbody> </table>	Code	Description	Qty	UOM	TR1142A0	EXHAUST FUMES THERMOSTAT	1	PZ								
Code	Description	Qty	UOM																		
TR1142A0	EXHAUST FUMES THERMOSTAT	1	PZ																		
0H6574B	LUX GAS COMPONENTS HOLDER		0H6574B0	LUX GAS COMPONENTS HOLDER																	



ASM2109B/0.D01 - Cooking chamber

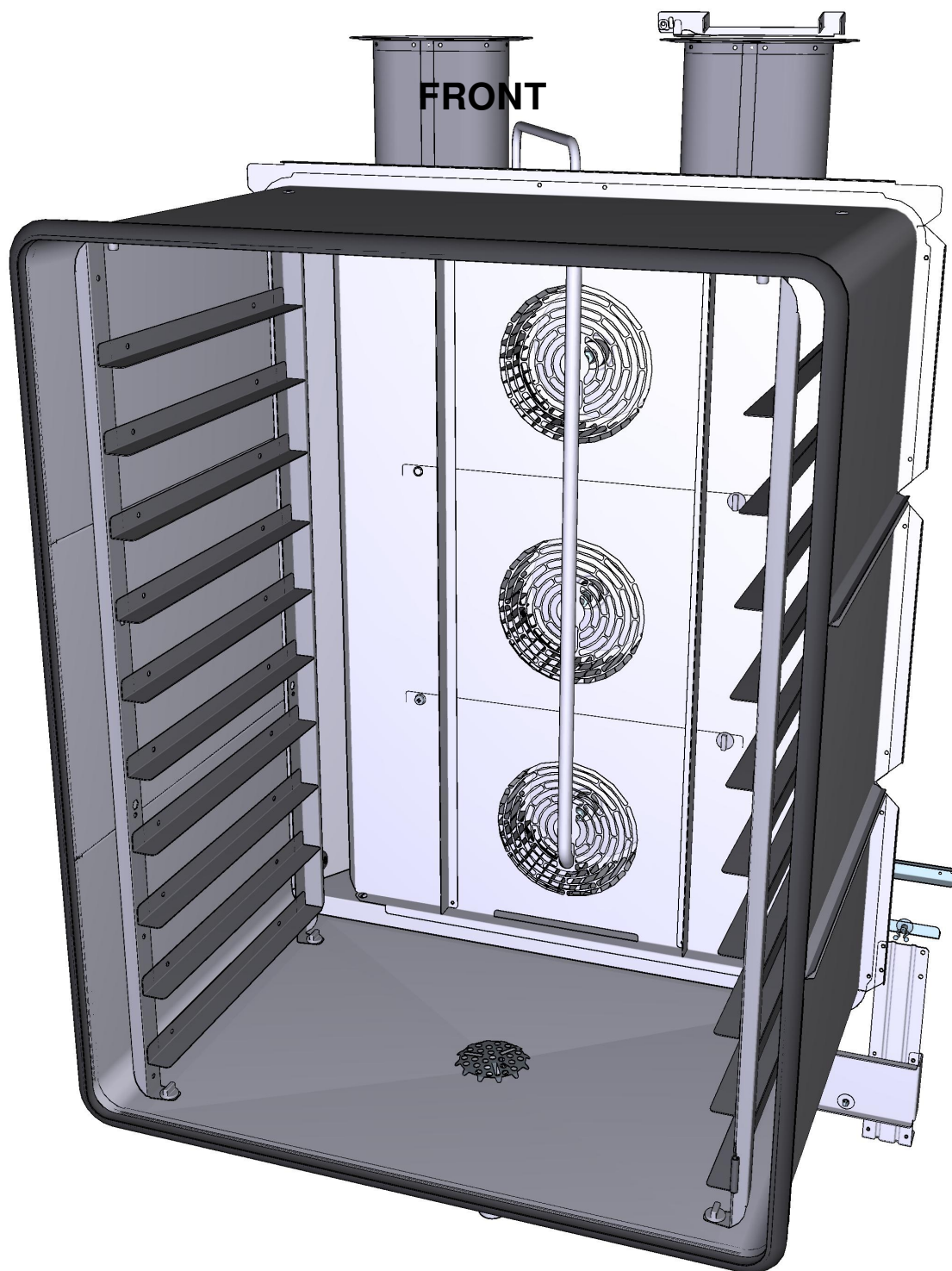



ASM2109B/0.D01 - Cooking chamber

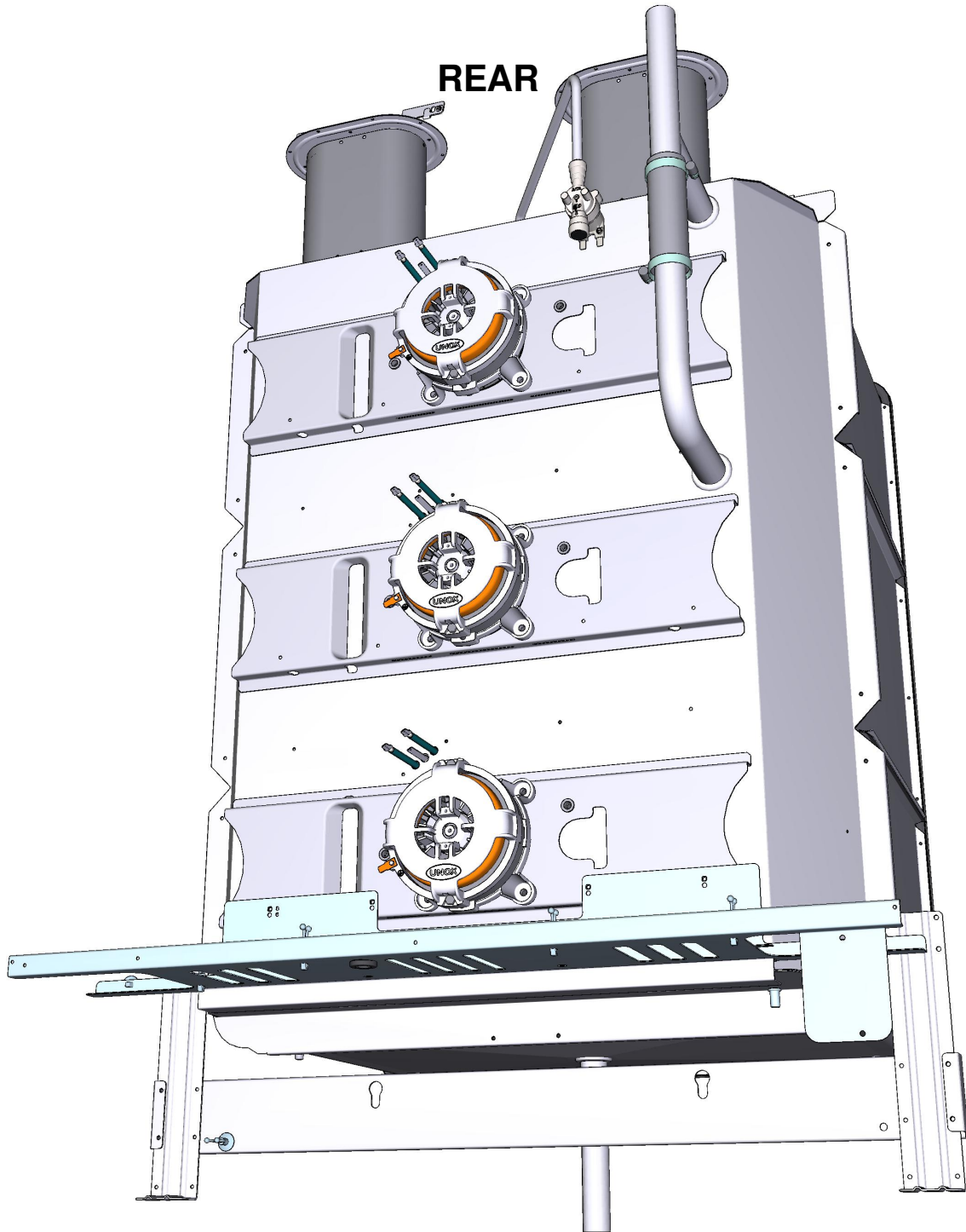

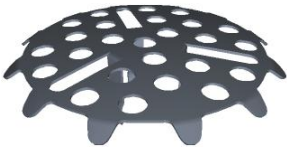
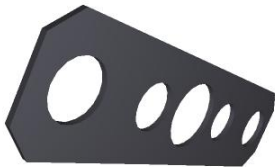

COMPONENT			SPARE PART																																		
Code	Description	Image	Code	Description	Components list																																
0H4820A	BULB HOLDING BRACKET		0H4820A1	BULB HOLDING BRACKET																																	
0H2551A	XBC/XVC ST.STEEL DRAIN COVER		K0H2551A	DRAIN COVER KIT	<table border="1"> <thead> <tr> <th>Code</th> <th>Description</th> <th>Qty</th> <th>UOM</th> </tr> </thead> <tbody> <tr> <td>0H2551A0</td> <td>XBC/XVC ST.STEEL DRAIN COVER</td> <td>1</td> <td>PZ</td> </tr> <tr> <td>VM1224A0</td> <td>65MY 220MM 2 COLOURS SHRINK TUBE</td> <td>0.200</td> <td>M</td> </tr> </tbody> </table>	Code	Description	Qty	UOM	0H2551A0	XBC/XVC ST.STEEL DRAIN COVER	1	PZ	VM1224A0	65MY 220MM 2 COLOURS SHRINK TUBE	0.200	M																				
Code	Description	Qty	UOM																																		
0H2551A0	XBC/XVC ST.STEEL DRAIN COVER	1	PZ																																		
VM1224A0	65MY 220MM 2 COLOURS SHRINK TUBE	0.200	M																																		
GN1326A	ELEMENT SEALING		KRS1274A	100W MOTOR BRAKING ELEMENT KIT	<table border="1"> <thead> <tr> <th>Code</th> <th>Description</th> <th>Qty</th> <th>UOM</th> </tr> </thead> <tbody> <tr> <td>GN1326A1</td> <td>ELEMENT SEALING</td> <td>1</td> <td>PZ</td> </tr> <tr> <td>GN1672A0</td> <td>RS1274A/RS1215A BREAKING ELEMENT GASKET</td> <td>1</td> <td>PZ</td> </tr> <tr> <td>GN1672A1</td> <td>RS1274A ELEMENT GASKET</td> <td>1</td> <td>PZ</td> </tr> <tr> <td>MOV0009A0</td> <td>HOOD RING GASKET GN1110A2</td> <td>0.100</td> <td>PZ</td> </tr> <tr> <td>RS1274A0</td> <td>100W 60V 1 TURN FLAT ELEMENT</td> <td>1</td> <td>PZ</td> </tr> <tr> <td>SL1045A0</td> <td>S57 BLACK SILICONE - 80ML CARTRIDGE</td> <td>1</td> <td>PZ</td> </tr> <tr> <td>VI1220A1</td> <td>4,2X12 TCB SELF-TAPPING SCREW</td> <td>2</td> <td>PZ</td> </tr> </tbody> </table>	Code	Description	Qty	UOM	GN1326A1	ELEMENT SEALING	1	PZ	GN1672A0	RS1274A/RS1215A BREAKING ELEMENT GASKET	1	PZ	GN1672A1	RS1274A ELEMENT GASKET	1	PZ	MOV0009A0	HOOD RING GASKET GN1110A2	0.100	PZ	RS1274A0	100W 60V 1 TURN FLAT ELEMENT	1	PZ	SL1045A0	S57 BLACK SILICONE - 80ML CARTRIDGE	1	PZ	VI1220A1	4,2X12 TCB SELF-TAPPING SCREW	2	PZ
Code	Description	Qty	UOM																																		
GN1326A1	ELEMENT SEALING	1	PZ																																		
GN1672A0	RS1274A/RS1215A BREAKING ELEMENT GASKET	1	PZ																																		
GN1672A1	RS1274A ELEMENT GASKET	1	PZ																																		
MOV0009A0	HOOD RING GASKET GN1110A2	0.100	PZ																																		
RS1274A0	100W 60V 1 TURN FLAT ELEMENT	1	PZ																																		
SL1045A0	S57 BLACK SILICONE - 80ML CARTRIDGE	1	PZ																																		
VI1220A1	4,2X12 TCB SELF-TAPPING SCREW	2	PZ																																		
			KRS1261A	122W MOTOR BRAKING ELEMENT KIT	<table border="1"> <thead> <tr> <th>Code</th> <th>Description</th> <th>Qty</th> <th>UOM</th> </tr> </thead> <tbody> <tr> <td>GN1326A1</td> <td>ELEMENT SEALING</td> <td>1</td> <td>PZ</td> </tr> <tr> <td>RS1261A0</td> <td>BAKERLUX/CH EFLUX MOTOR BREAKING ELEMENT</td> <td>1</td> <td>PZ</td> </tr> </tbody> </table>	Code	Description	Qty	UOM	GN1326A1	ELEMENT SEALING	1	PZ	RS1261A0	BAKERLUX/CH EFLUX MOTOR BREAKING ELEMENT	1	PZ																				
Code	Description	Qty	UOM																																		
GN1326A1	ELEMENT SEALING	1	PZ																																		
RS1261A0	BAKERLUX/CH EFLUX MOTOR BREAKING ELEMENT	1	PZ																																		

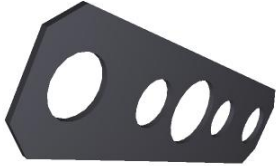
COMPONENT			SPARE PART																															
Code	Description	Image	Code	Description	Components list																													
GN1326A	ELEMENT SEALING		KRS1261A	122W MOTOR BREAKING ELEMENT KIT	<table border="1"> <thead> <tr> <th>Code</th> <th>Description</th> <th>Qty</th> <th>UOM</th> </tr> </thead> <tbody> <tr> <td>SL1045A0</td> <td>S57 BLACK SILICONE - 80ML CARTRIDGE</td> <td>1</td> <td>PZ</td> </tr> <tr> <td>VI1220A1</td> <td>4,2X12 TCB SELF-TAPPIN G SCREW</td> <td>2</td> <td>PZ</td> </tr> <tr> <td>VM2147A0</td> <td>410X343X15 MM PINK SMOOTH ESD SPONGE</td> <td>1</td> <td>PZ</td> </tr> </tbody> </table>	Code	Description	Qty	UOM	SL1045A0	S57 BLACK SILICONE - 80ML CARTRIDGE	1	PZ	VI1220A1	4,2X12 TCB SELF-TAPPIN G SCREW	2	PZ	VM2147A0	410X343X15 MM PINK SMOOTH ESD SPONGE	1	PZ													
			Code	Description	Qty	UOM																												
			SL1045A0	S57 BLACK SILICONE - 80ML CARTRIDGE	1	PZ																												
VI1220A1	4,2X12 TCB SELF-TAPPIN G SCREW	2	PZ																															
VM2147A0	410X343X15 MM PINK SMOOTH ESD SPONGE	1	PZ																															
KRS1215A	147W MOTOR BRAKING ELEMENT KIT	<table border="1"> <thead> <tr> <th>Code</th> <th>Description</th> <th>Qty</th> <th>UOM</th> </tr> </thead> <tbody> <tr> <td>GN1326A1</td> <td>ELEMENT SEALING</td> <td>1</td> <td>PZ</td> </tr> <tr> <td>GN1672A0</td> <td>RS1274A/RS12 15A BREAKING ELEMENT GASKET</td> <td>1</td> <td>PZ</td> </tr> <tr> <td>GN1672A1</td> <td>RS1274A ELEMENT GASKET</td> <td>1</td> <td>PZ</td> </tr> <tr> <td>MOV0009A0</td> <td>HOOD RING GASKET GN1110A2</td> <td>0.100</td> <td>PZ</td> </tr> <tr> <td>RS1215A1</td> <td>147W 105V BRAKING ELEMENT</td> <td>1</td> <td>PZ</td> </tr> <tr> <td>SL1045A0</td> <td>S57 BLACK SILICONE - 80ML CARTRIDGE</td> <td>1</td> <td>PZ</td> </tr> <tr> <td>VI1220A1</td> <td>4,2X12 TCB SELF-TAPPIN G SCREW</td> <td>2</td> <td>PZ</td> </tr> </tbody> </table>	Code	Description	Qty	UOM	GN1326A1	ELEMENT SEALING	1	PZ	GN1672A0	RS1274A/RS12 15A BREAKING ELEMENT GASKET	1	PZ	GN1672A1	RS1274A ELEMENT GASKET	1	PZ	MOV0009A0	HOOD RING GASKET GN1110A2	0.100	PZ	RS1215A1	147W 105V BRAKING ELEMENT	1	PZ	SL1045A0	S57 BLACK SILICONE - 80ML CARTRIDGE	1	PZ	VI1220A1	4,2X12 TCB SELF-TAPPIN G SCREW	2	PZ
Code	Description	Qty	UOM																															
GN1326A1	ELEMENT SEALING	1	PZ																															
GN1672A0	RS1274A/RS12 15A BREAKING ELEMENT GASKET	1	PZ																															
GN1672A1	RS1274A ELEMENT GASKET	1	PZ																															
MOV0009A0	HOOD RING GASKET GN1110A2	0.100	PZ																															
RS1215A1	147W 105V BRAKING ELEMENT	1	PZ																															
SL1045A0	S57 BLACK SILICONE - 80ML CARTRIDGE	1	PZ																															
VI1220A1	4,2X12 TCB SELF-TAPPIN G SCREW	2	PZ																															
KRS1095A	1.2KW HEATING ELEMENT KIT	<table border="1"> <thead> <tr> <th>Code</th> <th>Description</th> <th>Qty</th> <th>UOM</th> </tr> </thead> <tbody> <tr> <td>GN1326A1</td> <td>ELEMENT SEALING</td> <td>1</td> <td>PZ</td> </tr> <tr> <td>IP1385A1</td> <td>CORNER POLYSTYREN E PACKING 110X80X2000</td> <td>0.500</td> <td>M</td> </tr> <tr> <td>RS1095A1</td> <td>HEATING ELEMENT 1200W 230V</td> <td>1</td> <td>PZ</td> </tr> <tr> <td>SL1045A0</td> <td>S57 BLACK SILICONE - 80ML CARTRIDGE</td> <td>1</td> <td>PZ</td> </tr> <tr> <td>VI1220A1</td> <td>4,2X12 TCB SELF-TAPPIN G SCREW</td> <td>2</td> <td>PZ</td> </tr> <tr> <td>VM1059A1</td> <td>HEAT SHRINK FILM H800</td> <td>1.200</td> <td>M</td> </tr> </tbody> </table>	Code	Description	Qty	UOM	GN1326A1	ELEMENT SEALING	1	PZ	IP1385A1	CORNER POLYSTYREN E PACKING 110X80X2000	0.500	M	RS1095A1	HEATING ELEMENT 1200W 230V	1	PZ	SL1045A0	S57 BLACK SILICONE - 80ML CARTRIDGE	1	PZ	VI1220A1	4,2X12 TCB SELF-TAPPIN G SCREW	2	PZ	VM1059A1	HEAT SHRINK FILM H800	1.200	M				
Code	Description	Qty	UOM																															
GN1326A1	ELEMENT SEALING	1	PZ																															
IP1385A1	CORNER POLYSTYREN E PACKING 110X80X2000	0.500	M																															
RS1095A1	HEATING ELEMENT 1200W 230V	1	PZ																															
SL1045A0	S57 BLACK SILICONE - 80ML CARTRIDGE	1	PZ																															
VI1220A1	4,2X12 TCB SELF-TAPPIN G SCREW	2	PZ																															
VM1059A1	HEAT SHRINK FILM H800	1.200	M																															

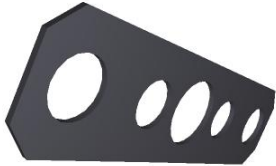

COMPONENT			SPARE PART																																		
Code	Description	Image	Code	Description	Components list																																
GN1326A	ELEMENT SEALING		KRS1012A	1365W 120V HEATING ELEMENT KIT	<table border="1"> <thead> <tr> <th>Code</th> <th>Description</th> <th>Qty</th> <th>UOM</th> </tr> </thead> <tbody> <tr> <td>GN1326A1</td> <td>ELEMENT SEALING</td> <td>1</td> <td>PZ</td> </tr> <tr> <td>MOV0008A0</td> <td>HOOD RING GASKET GN1110A2</td> <td>0.100</td> <td>PZ</td> </tr> <tr> <td>RS1012A0</td> <td>CIRCULAR ELEMENT 1365W 120V</td> <td>1</td> <td>PZ</td> </tr> <tr> <td>VI1220A1</td> <td>4,2X12 TCB SELF-TAPPIN G SCREW</td> <td>5</td> <td>PZ</td> </tr> <tr> <td>VM1794A0</td> <td>250X4.8 PA66 BLACK CLAMP</td> <td>2</td> <td>PZ</td> </tr> <tr> <td>VM2103A0</td> <td>CLAMP LOCK</td> <td>2</td> <td>PZ</td> </tr> </tbody> </table>	Code	Description	Qty	UOM	GN1326A1	ELEMENT SEALING	1	PZ	MOV0008A0	HOOD RING GASKET GN1110A2	0.100	PZ	RS1012A0	CIRCULAR ELEMENT 1365W 120V	1	PZ	VI1220A1	4,2X12 TCB SELF-TAPPIN G SCREW	5	PZ	VM1794A0	250X4.8 PA66 BLACK CLAMP	2	PZ	VM2103A0	CLAMP LOCK	2	PZ				
			Code	Description	Qty	UOM																															
			GN1326A1	ELEMENT SEALING	1	PZ																															
			MOV0008A0	HOOD RING GASKET GN1110A2	0.100	PZ																															
			RS1012A0	CIRCULAR ELEMENT 1365W 120V	1	PZ																															
			VI1220A1	4,2X12 TCB SELF-TAPPIN G SCREW	5	PZ																															
			VM1794A0	250X4.8 PA66 BLACK CLAMP	2	PZ																															
			VM2103A0	CLAMP LOCK	2	PZ																															
			KRS1011A	ROBERTA/LISA HEATING ELEMENT KIT	<table border="1"> <thead> <tr> <th>Code</th> <th>Description</th> <th>Qty</th> <th>UOM</th> </tr> </thead> <tbody> <tr> <td>GN1326A1</td> <td>ELEMENT SEALING</td> <td>1</td> <td>PZ</td> </tr> <tr> <td>MOV0008A0</td> <td>HOOD RING GASKET GN1110A2</td> <td>0.100</td> <td>PZ</td> </tr> <tr> <td>RS1011A0</td> <td>2560W 220-230V HEATING ELEMENT</td> <td>1</td> <td>PZ</td> </tr> <tr> <td>SL1045A0</td> <td>S57 BLACK SILICONE - 80ML CARTRIDGE</td> <td>1</td> <td>PZ</td> </tr> <tr> <td>VI1220A1</td> <td>4,2X12 TCB SELF-TAPPIN G SCREW</td> <td>5</td> <td>PZ</td> </tr> <tr> <td>VM1794A0</td> <td>250X4.8 PA66 BLACK CLAMP</td> <td>2</td> <td>PZ</td> </tr> <tr> <td>VM2103A0</td> <td>CLAMP LOCK</td> <td>2</td> <td>PZ</td> </tr> </tbody> </table>	Code	Description	Qty	UOM	GN1326A1	ELEMENT SEALING	1	PZ	MOV0008A0	HOOD RING GASKET GN1110A2	0.100	PZ	RS1011A0	2560W 220-230V HEATING ELEMENT	1	PZ	SL1045A0	S57 BLACK SILICONE - 80ML CARTRIDGE	1	PZ	VI1220A1	4,2X12 TCB SELF-TAPPIN G SCREW	5	PZ	VM1794A0	250X4.8 PA66 BLACK CLAMP	2	PZ	VM2103A0	CLAMP LOCK	2	PZ
			Code	Description	Qty	UOM																															
			GN1326A1	ELEMENT SEALING	1	PZ																															
			MOV0008A0	HOOD RING GASKET GN1110A2	0.100	PZ																															
RS1011A0	2560W 220-230V HEATING ELEMENT	1	PZ																																		
SL1045A0	S57 BLACK SILICONE - 80ML CARTRIDGE	1	PZ																																		
VI1220A1	4,2X12 TCB SELF-TAPPIN G SCREW	5	PZ																																		
VM1794A0	250X4.8 PA66 BLACK CLAMP	2	PZ																																		
VM2103A0	CLAMP LOCK	2	PZ																																		
KRS0090A	HEATING ELEMENT 1.26KW	<table border="1"> <thead> <tr> <th>Code</th> <th>Description</th> <th>Qty</th> <th>UOM</th> </tr> </thead> <tbody> <tr> <td>GN1326A1</td> <td>ELEMENT SEALING</td> <td>1</td> <td>PZ</td> </tr> <tr> <td>RS0090A0</td> <td>CIRC. HEAT. ELEMENT 1260W 220-230</td> <td>1</td> <td>PZ</td> </tr> <tr> <td>VI1220A1</td> <td>4,2X12 TCB SELF-TAPPIN G SCREW</td> <td>3</td> <td>PZ</td> </tr> <tr> <td>VM1794A0</td> <td>250X4.8 PA66 BLACK CLAMP</td> <td>2</td> <td>PZ</td> </tr> <tr> <td>VM2103A0</td> <td>CLAMP LOCK</td> <td>2</td> <td>PZ</td> </tr> </tbody> </table>	Code	Description	Qty	UOM	GN1326A1	ELEMENT SEALING	1	PZ	RS0090A0	CIRC. HEAT. ELEMENT 1260W 220-230	1	PZ	VI1220A1	4,2X12 TCB SELF-TAPPIN G SCREW	3	PZ	VM1794A0	250X4.8 PA66 BLACK CLAMP	2	PZ	VM2103A0	CLAMP LOCK	2	PZ											
Code	Description	Qty	UOM																																		
GN1326A1	ELEMENT SEALING	1	PZ																																		
RS0090A0	CIRC. HEAT. ELEMENT 1260W 220-230	1	PZ																																		
VI1220A1	4,2X12 TCB SELF-TAPPIN G SCREW	3	PZ																																		
VM1794A0	250X4.8 PA66 BLACK CLAMP	2	PZ																																		
VM2103A0	CLAMP LOCK	2	PZ																																		
KRS0050A	HEATING ELEMENT KIT 0.5KW	<table border="1"> <thead> <tr> <th>Code</th> <th>Description</th> <th>Qty</th> <th>UOM</th> </tr> </thead> <tbody> <tr> <td>GN1326A1</td> <td>ELEMENT SEALING</td> <td>1</td> <td>PZ</td> </tr> </tbody> </table>	Code	Description	Qty	UOM	GN1326A1	ELEMENT SEALING	1	PZ																											
Code	Description	Qty	UOM																																		
GN1326A1	ELEMENT SEALING	1	PZ																																		

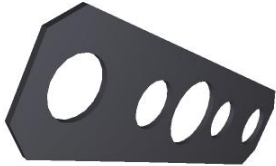
COMPONENT			SPARE PART																									
Code	Description	Image	Code	Description	Components list																							
GN1326A	ELEMENT SEALING		KRS0050A	HEATING ELEMENT KIT 0.5KW	<table border="1"> <thead> <tr> <th>Code</th> <th>Description</th> <th>Qty</th> <th>UOM</th> </tr> </thead> <tbody> <tr> <td>IP1075A1</td> <td>70X150X765 D=10 POLYSTYRE WITH PRECUT</td> <td>1</td> <td>PZ</td> </tr> <tr> <td>IP1080A1</td> <td>280X255X10 D=10 POLYSTYREN</td> <td>1</td> <td>PZ</td> </tr> <tr> <td>RS0050A0</td> <td>HEAT. ELEMENT 500W 220-230V LIEV</td> <td>1</td> <td>PZ</td> </tr> </tbody> </table>	Code	Description	Qty	UOM	IP1075A1	70X150X765 D=10 POLYSTYRE WITH PRECUT	1	PZ	IP1080A1	280X255X10 D=10 POLYSTYREN	1	PZ	RS0050A0	HEAT. ELEMENT 500W 220-230V LIEV	1	PZ							
					Code	Description	Qty	UOM																				
					IP1075A1	70X150X765 D=10 POLYSTYRE WITH PRECUT	1	PZ																				
					IP1080A1	280X255X10 D=10 POLYSTYREN	1	PZ																				
			RS0050A0	HEAT. ELEMENT 500W 220-230V LIEV	1	PZ																						
			<table border="1"> <thead> <tr> <th>Code</th> <th>Description</th> <th>Qty</th> <th>UOM</th> </tr> </thead> <tbody> <tr> <td>GN1326A1</td> <td>ELEMENT SEALING</td> <td>1</td> <td>PZ</td> </tr> <tr> <td>RS0011A0</td> <td>CIRC.HEAT. ELEMENT 1465W 220-230</td> <td>1</td> <td>PZ</td> </tr> <tr> <td>VI1220A1</td> <td>4,2X12 TCB SELF-TAPPIN G SCREW</td> <td>2</td> <td>PZ</td> </tr> </tbody> </table>	Code	Description	Qty	UOM	GN1326A1	ELEMENT SEALING	1	PZ	RS0011A0	CIRC.HEAT. ELEMENT 1465W 220-230	1	PZ	VI1220A1	4,2X12 TCB SELF-TAPPIN G SCREW	2	PZ									
			Code	Description	Qty	UOM																						
			GN1326A1	ELEMENT SEALING	1	PZ																						
			RS0011A0	CIRC.HEAT. ELEMENT 1465W 220-230	1	PZ																						
			VI1220A1	4,2X12 TCB SELF-TAPPIN G SCREW	2	PZ																						
			<table border="1"> <thead> <tr> <th>Code</th> <th>Description</th> <th>Qty</th> <th>UOM</th> </tr> </thead> <tbody> <tr> <td>GN1326A1</td> <td>ELEMENT SEALING</td> <td>1</td> <td>PZ</td> </tr> <tr> <td>RS0011A0</td> <td>CIRC.HEAT. ELEMENT 1465W 220-230</td> <td>1</td> <td>PZ</td> </tr> <tr> <td>VI1220A1</td> <td>4,2X12 TCB SELF-TAPPIN G SCREW</td> <td>3</td> <td>PZ</td> </tr> <tr> <td>VM1794A0</td> <td>250X4.8 PA66 BLACK CLAMP</td> <td>2</td> <td>PZ</td> </tr> <tr> <td>VM2103A0</td> <td>CLAMP LOCK</td> <td>2</td> <td>PZ</td> </tr> </tbody> </table>	Code	Description	Qty	UOM	GN1326A1	ELEMENT SEALING	1	PZ	RS0011A0	CIRC.HEAT. ELEMENT 1465W 220-230	1	PZ	VI1220A1	4,2X12 TCB SELF-TAPPIN G SCREW	3	PZ	VM1794A0	250X4.8 PA66 BLACK CLAMP	2	PZ	VM2103A0	CLAMP LOCK	2	PZ	
			Code	Description	Qty	UOM																						
GN1326A1	ELEMENT SEALING	1	PZ																									
RS0011A0	CIRC.HEAT. ELEMENT 1465W 220-230	1	PZ																									
VI1220A1	4,2X12 TCB SELF-TAPPIN G SCREW	3	PZ																									
VM1794A0	250X4.8 PA66 BLACK CLAMP	2	PZ																									
VM2103A0	CLAMP LOCK	2	PZ																									
<table border="1"> <thead> <tr> <th>Code</th> <th>Description</th> <th>Qty</th> <th>UOM</th> </tr> </thead> <tbody> <tr> <td>GN1326A1</td> <td>ELEMENT SEALING</td> <td>1</td> <td>PZ</td> </tr> <tr> <td>IP1075A1</td> <td>70X150X765 D=10 POLYSTYRE WITH PRECUT</td> <td>1</td> <td>PZ</td> </tr> <tr> <td>IP1080A1</td> <td>280X255X10 D=10 POLYSTYREN</td> <td>5</td> <td>PZ</td> </tr> <tr> <td>RS0010A0</td> <td>CIRC.HEAT. ELEMENT 2560W - 220-230 V</td> <td>1</td> <td>PZ</td> </tr> <tr> <td>VI1220A1</td> <td>4,2X12 TCB SELF-TAPPIN G SCREW</td> <td>3</td> <td>PZ</td> </tr> </tbody> </table>	Code	Description	Qty	UOM	GN1326A1	ELEMENT SEALING	1	PZ	IP1075A1	70X150X765 D=10 POLYSTYRE WITH PRECUT	1	PZ	IP1080A1	280X255X10 D=10 POLYSTYREN	5	PZ	RS0010A0	CIRC.HEAT. ELEMENT 2560W - 220-230 V	1	PZ	VI1220A1	4,2X12 TCB SELF-TAPPIN G SCREW	3	PZ				
Code	Description	Qty	UOM																									
GN1326A1	ELEMENT SEALING	1	PZ																									
IP1075A1	70X150X765 D=10 POLYSTYRE WITH PRECUT	1	PZ																									
IP1080A1	280X255X10 D=10 POLYSTYREN	5	PZ																									
RS0010A0	CIRC.HEAT. ELEMENT 2560W - 220-230 V	1	PZ																									
VI1220A1	4,2X12 TCB SELF-TAPPIN G SCREW	3	PZ																									
<table border="1"> <thead> <tr> <th>Code</th> <th>Description</th> <th>Qty</th> <th>UOM</th> </tr> </thead> <tbody> <tr> <td>GN1326A1</td> <td>ELEMENT SEALING</td> <td>5</td> <td>PZ</td> </tr> <tr> <td>VM1224A0</td> <td>65MY 220MM 2 COLOURS SHRINK TUBE</td> <td>0.200</td> <td>M</td> </tr> </tbody> </table>	Code	Description	Qty	UOM	GN1326A1	ELEMENT SEALING	5	PZ	VM1224A0	65MY 220MM 2 COLOURS SHRINK TUBE	0.200	M																
Code	Description	Qty	UOM																									
GN1326A1	ELEMENT SEALING	5	PZ																									
VM1224A0	65MY 220MM 2 COLOURS SHRINK TUBE	0.200	M																									
KRS0011A	HEATING ELEMENT 1.465KW RS0011A	KRS0010A	KIT HEATING ELEMENT RS10010A	<table border="1"> <thead> <tr> <th>Code</th> <th>Description</th> <th>Qty</th> <th>UOM</th> </tr> </thead> <tbody> <tr> <td>GN1326A1</td> <td>ELEMENT SEALING</td> <td>1</td> <td>PZ</td> </tr> <tr> <td>IP1075A1</td> <td>70X150X765 D=10 POLYSTYRE WITH PRECUT</td> <td>1</td> <td>PZ</td> </tr> <tr> <td>IP1080A1</td> <td>280X255X10 D=10 POLYSTYREN</td> <td>5</td> <td>PZ</td> </tr> <tr> <td>RS0010A0</td> <td>CIRC.HEAT. ELEMENT 2560W - 220-230 V</td> <td>1</td> <td>PZ</td> </tr> <tr> <td>VI1220A1</td> <td>4,2X12 TCB SELF-TAPPIN G SCREW</td> <td>3</td> <td>PZ</td> </tr> </tbody> </table>	Code	Description	Qty	UOM	GN1326A1	ELEMENT SEALING	1	PZ	IP1075A1	70X150X765 D=10 POLYSTYRE WITH PRECUT	1	PZ	IP1080A1	280X255X10 D=10 POLYSTYREN	5	PZ	RS0010A0	CIRC.HEAT. ELEMENT 2560W - 220-230 V	1	PZ	VI1220A1	4,2X12 TCB SELF-TAPPIN G SCREW	3	PZ
					Code	Description	Qty	UOM																				
					GN1326A1	ELEMENT SEALING	1	PZ																				
IP1075A1	70X150X765 D=10 POLYSTYRE WITH PRECUT	1	PZ																									
IP1080A1	280X255X10 D=10 POLYSTYREN	5	PZ																									
RS0010A0	CIRC.HEAT. ELEMENT 2560W - 220-230 V	1	PZ																									
VI1220A1	4,2X12 TCB SELF-TAPPIN G SCREW	3	PZ																									
<table border="1"> <thead> <tr> <th>Code</th> <th>Description</th> <th>Qty</th> <th>UOM</th> </tr> </thead> <tbody> <tr> <td>GN1326A1</td> <td>ELEMENT SEALING</td> <td>1</td> <td>PZ</td> </tr> <tr> <td>IP1075A1</td> <td>70X150X765 D=10 POLYSTYRE WITH PRECUT</td> <td>1</td> <td>PZ</td> </tr> <tr> <td>IP1080A1</td> <td>280X255X10 D=10 POLYSTYREN</td> <td>5</td> <td>PZ</td> </tr> <tr> <td>RS0010A0</td> <td>CIRC.HEAT. ELEMENT 2560W - 220-230 V</td> <td>1</td> <td>PZ</td> </tr> <tr> <td>VI1220A1</td> <td>4,2X12 TCB SELF-TAPPIN G SCREW</td> <td>3</td> <td>PZ</td> </tr> </tbody> </table>	Code	Description	Qty	UOM	GN1326A1	ELEMENT SEALING	1	PZ	IP1075A1	70X150X765 D=10 POLYSTYRE WITH PRECUT	1	PZ	IP1080A1	280X255X10 D=10 POLYSTYREN	5	PZ	RS0010A0	CIRC.HEAT. ELEMENT 2560W - 220-230 V	1	PZ	VI1220A1	4,2X12 TCB SELF-TAPPIN G SCREW	3	PZ				
Code	Description	Qty	UOM																									
GN1326A1	ELEMENT SEALING	1	PZ																									
IP1075A1	70X150X765 D=10 POLYSTYRE WITH PRECUT	1	PZ																									
IP1080A1	280X255X10 D=10 POLYSTYREN	5	PZ																									
RS0010A0	CIRC.HEAT. ELEMENT 2560W - 220-230 V	1	PZ																									
VI1220A1	4,2X12 TCB SELF-TAPPIN G SCREW	3	PZ																									
<table border="1"> <thead> <tr> <th>Code</th> <th>Description</th> <th>Qty</th> <th>UOM</th> </tr> </thead> <tbody> <tr> <td>GN1326A1</td> <td>ELEMENT SEALING</td> <td>1</td> <td>PZ</td> </tr> <tr> <td>IP1075A1</td> <td>70X150X765 D=10 POLYSTYRE WITH PRECUT</td> <td>1</td> <td>PZ</td> </tr> <tr> <td>IP1080A1</td> <td>280X255X10 D=10 POLYSTYREN</td> <td>5</td> <td>PZ</td> </tr> <tr> <td>RS0010A0</td> <td>CIRC.HEAT. ELEMENT 2560W - 220-230 V</td> <td>1</td> <td>PZ</td> </tr> <tr> <td>VI1220A1</td> <td>4,2X12 TCB SELF-TAPPIN G SCREW</td> <td>3</td> <td>PZ</td> </tr> </tbody> </table>	Code	Description	Qty	UOM	GN1326A1	ELEMENT SEALING	1	PZ	IP1075A1	70X150X765 D=10 POLYSTYRE WITH PRECUT	1	PZ	IP1080A1	280X255X10 D=10 POLYSTYREN	5	PZ	RS0010A0	CIRC.HEAT. ELEMENT 2560W - 220-230 V	1	PZ	VI1220A1	4,2X12 TCB SELF-TAPPIN G SCREW	3	PZ				
Code	Description	Qty	UOM																									
GN1326A1	ELEMENT SEALING	1	PZ																									
IP1075A1	70X150X765 D=10 POLYSTYRE WITH PRECUT	1	PZ																									
IP1080A1	280X255X10 D=10 POLYSTYREN	5	PZ																									
RS0010A0	CIRC.HEAT. ELEMENT 2560W - 220-230 V	1	PZ																									
VI1220A1	4,2X12 TCB SELF-TAPPIN G SCREW	3	PZ																									
KRS0010A	KIT HEATING ELEMENT RS10010A	KGN1326A	HEATING ELEMENT GASKET 5 PCS KIT	<table border="1"> <thead> <tr> <th>Code</th> <th>Description</th> <th>Qty</th> <th>UOM</th> </tr> </thead> <tbody> <tr> <td>GN1326A1</td> <td>ELEMENT SEALING</td> <td>1</td> <td>PZ</td> </tr> <tr> <td>IP1075A1</td> <td>70X150X765 D=10 POLYSTYRE WITH PRECUT</td> <td>1</td> <td>PZ</td> </tr> <tr> <td>IP1080A1</td> <td>280X255X10 D=10 POLYSTYREN</td> <td>5</td> <td>PZ</td> </tr> <tr> <td>RS0010A0</td> <td>CIRC.HEAT. ELEMENT 2560W - 220-230 V</td> <td>1</td> <td>PZ</td> </tr> <tr> <td>VI1220A1</td> <td>4,2X12 TCB SELF-TAPPIN G SCREW</td> <td>3</td> <td>PZ</td> </tr> </tbody> </table>	Code	Description	Qty	UOM	GN1326A1	ELEMENT SEALING	1	PZ	IP1075A1	70X150X765 D=10 POLYSTYRE WITH PRECUT	1	PZ	IP1080A1	280X255X10 D=10 POLYSTYREN	5	PZ	RS0010A0	CIRC.HEAT. ELEMENT 2560W - 220-230 V	1	PZ	VI1220A1	4,2X12 TCB SELF-TAPPIN G SCREW	3	PZ
					Code	Description	Qty	UOM																				
GN1326A1	ELEMENT SEALING	1	PZ																									
IP1075A1	70X150X765 D=10 POLYSTYRE WITH PRECUT	1	PZ																									
IP1080A1	280X255X10 D=10 POLYSTYREN	5	PZ																									
RS0010A0	CIRC.HEAT. ELEMENT 2560W - 220-230 V	1	PZ																									
VI1220A1	4,2X12 TCB SELF-TAPPIN G SCREW	3	PZ																									
<table border="1"> <thead> <tr> <th>Code</th> <th>Description</th> <th>Qty</th> <th>UOM</th> </tr> </thead> <tbody> <tr> <td>GN1326A1</td> <td>ELEMENT SEALING</td> <td>1</td> <td>PZ</td> </tr> <tr> <td>IP1075A1</td> <td>70X150X765 D=10 POLYSTYRE WITH PRECUT</td> <td>1</td> <td>PZ</td> </tr> <tr> <td>IP1080A1</td> <td>280X255X10 D=10 POLYSTYREN</td> <td>5</td> <td>PZ</td> </tr> <tr> <td>RS0010A0</td> <td>CIRC.HEAT. ELEMENT 2560W - 220-230 V</td> <td>1</td> <td>PZ</td> </tr> <tr> <td>VI1220A1</td> <td>4,2X12 TCB SELF-TAPPIN G SCREW</td> <td>3</td> <td>PZ</td> </tr> </tbody> </table>	Code	Description	Qty	UOM	GN1326A1	ELEMENT SEALING	1	PZ	IP1075A1	70X150X765 D=10 POLYSTYRE WITH PRECUT	1	PZ	IP1080A1	280X255X10 D=10 POLYSTYREN	5	PZ	RS0010A0	CIRC.HEAT. ELEMENT 2560W - 220-230 V	1	PZ	VI1220A1	4,2X12 TCB SELF-TAPPIN G SCREW	3	PZ				
Code	Description	Qty	UOM																									
GN1326A1	ELEMENT SEALING	1	PZ																									
IP1075A1	70X150X765 D=10 POLYSTYRE WITH PRECUT	1	PZ																									
IP1080A1	280X255X10 D=10 POLYSTYREN	5	PZ																									
RS0010A0	CIRC.HEAT. ELEMENT 2560W - 220-230 V	1	PZ																									
VI1220A1	4,2X12 TCB SELF-TAPPIN G SCREW	3	PZ																									

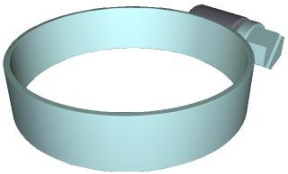
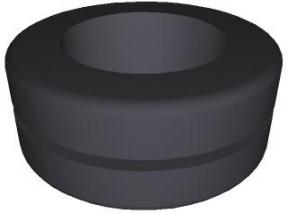
COMPONENT			SPARE PART																																																														
Code	Description	Image	Code	Description	Components list																																																												
RC1378A	HOSE CLAMP		KVE1135A	SERIES 5/5E VENTURI KIT	<table border="1"> <thead> <tr> <th>Code</th> <th>Description</th> <th>Qty</th> <th>UOM</th> </tr> </thead> <tbody> <tr> <td>GN1556A0</td> <td>MM VENTURI SEAL</td> <td>1</td> <td>PZ</td> </tr> <tr> <td>RC1378A0</td> <td>HOSE CLAMP</td> <td>2</td> <td>PZ</td> </tr> <tr> <td>TB1520A0</td> <td>INT. Ø=38 TH=4 DRAIN BLACK RUBBER PIPE</td> <td>0.050</td> <td>M</td> </tr> <tr> <td>VE1135A0</td> <td>220 V 50/60 HZ VENTURI ACTUATOR</td> <td>1</td> <td>PZ</td> </tr> <tr> <td>VI1032A0</td> <td>SCREW M4X16 TCB+ INOX</td> <td>1</td> <td>PZ</td> </tr> <tr> <td>VI1511A0</td> <td>STAINLESS STEEL WASHER 4.2X12X1</td> <td>2</td> <td>PZ</td> </tr> <tr> <td>VI1850A0</td> <td>M4X6 NICKEL PLATED FIXING SCREW</td> <td>2</td> <td>PZ</td> </tr> <tr> <td>VI1865A0</td> <td>5X10 TCB+ SELF-THREADING SCREW</td> <td>3</td> <td>PZ</td> </tr> <tr> <td>VI1965A0</td> <td>M4X6 CROSS-HEAD ST. STEEL SCREW</td> <td>2</td> <td>PZ</td> </tr> <tr> <td>VM1224A0</td> <td>65MY 220MM COLOURS SHRINK TUBE</td> <td>0.250</td> <td>M</td> </tr> <tr> <td>VM1565B0</td> <td>VENTURI LOWER COIL SUPPORT</td> <td>1</td> <td>PZ</td> </tr> <tr> <td>VM1566A0</td> <td>VENTURI UPPER COIL SUPPORT</td> <td>1</td> <td>PZ</td> </tr> <tr> <td>VM1567A0</td> <td>VENTURI LOWER BUSHING</td> <td>1</td> <td>PZ</td> </tr> <tr> <td>VM1568A0</td> <td>VENTURI PLATE SPACE</td> <td>1</td> <td>PZ</td> </tr> </tbody> </table>	Code	Description	Qty	UOM	GN1556A0	MM VENTURI SEAL	1	PZ	RC1378A0	HOSE CLAMP	2	PZ	TB1520A0	INT. Ø=38 TH=4 DRAIN BLACK RUBBER PIPE	0.050	M	VE1135A0	220 V 50/60 HZ VENTURI ACTUATOR	1	PZ	VI1032A0	SCREW M4X16 TCB+ INOX	1	PZ	VI1511A0	STAINLESS STEEL WASHER 4.2X12X1	2	PZ	VI1850A0	M4X6 NICKEL PLATED FIXING SCREW	2	PZ	VI1865A0	5X10 TCB+ SELF-THREADING SCREW	3	PZ	VI1965A0	M4X6 CROSS-HEAD ST. STEEL SCREW	2	PZ	VM1224A0	65MY 220MM COLOURS SHRINK TUBE	0.250	M	VM1565B0	VENTURI LOWER COIL SUPPORT	1	PZ	VM1566A0	VENTURI UPPER COIL SUPPORT	1	PZ	VM1567A0	VENTURI LOWER BUSHING	1	PZ	VM1568A0	VENTURI PLATE SPACE	1	PZ
					Code	Description	Qty	UOM																																																									
					GN1556A0	MM VENTURI SEAL	1	PZ																																																									
					RC1378A0	HOSE CLAMP	2	PZ																																																									
					TB1520A0	INT. Ø=38 TH=4 DRAIN BLACK RUBBER PIPE	0.050	M																																																									
					VE1135A0	220 V 50/60 HZ VENTURI ACTUATOR	1	PZ																																																									
					VI1032A0	SCREW M4X16 TCB+ INOX	1	PZ																																																									
					VI1511A0	STAINLESS STEEL WASHER 4.2X12X1	2	PZ																																																									
					VI1850A0	M4X6 NICKEL PLATED FIXING SCREW	2	PZ																																																									
					VI1865A0	5X10 TCB+ SELF-THREADING SCREW	3	PZ																																																									
					VI1965A0	M4X6 CROSS-HEAD ST. STEEL SCREW	2	PZ																																																									
					VM1224A0	65MY 220MM COLOURS SHRINK TUBE	0.250	M																																																									
					VM1565B0	VENTURI LOWER COIL SUPPORT	1	PZ																																																									
					VM1566A0	VENTURI UPPER COIL SUPPORT	1	PZ																																																									
					VM1567A0	VENTURI LOWER BUSHING	1	PZ																																																									
VM1568A0	VENTURI PLATE SPACE	1	PZ																																																														
GN1312A	RUBBER CABLE-PASSING DE=26 DI=15 SP=10		KVL0001A	LM TOP CLEANING SYSTEM KIT	<table border="1"> <thead> <tr> <th>Code</th> <th>Description</th> <th>Qty</th> <th>UOM</th> </tr> </thead> <tbody> <tr> <td>0H1226B0</td> <td>LINEMISSTOP WASHING SYTEM CIRCUIT COVE</td> <td>1</td> <td>PZ</td> </tr> <tr> <td>0H2143A0</td> <td>LAMIERA BLOCCA VNR VL1128</td> <td>2</td> <td>PZ</td> </tr> <tr> <td>EL1436B0</td> <td>JG D8-BARBED D6 NRV WATER SOLENOID</td> <td>1</td> <td>PZ</td> </tr> </tbody> </table>	Code	Description	Qty	UOM	0H1226B0	LINEMISSTOP WASHING SYTEM CIRCUIT COVE	1	PZ	0H2143A0	LAMIERA BLOCCA VNR VL1128	2	PZ	EL1436B0	JG D8-BARBED D6 NRV WATER SOLENOID	1	PZ																																												
					Code	Description	Qty	UOM																																																									
					0H1226B0	LINEMISSTOP WASHING SYTEM CIRCUIT COVE	1	PZ																																																									
0H2143A0	LAMIERA BLOCCA VNR VL1128	2	PZ																																																														
EL1436B0	JG D8-BARBED D6 NRV WATER SOLENOID	1	PZ																																																														



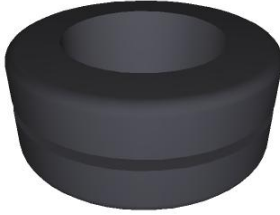

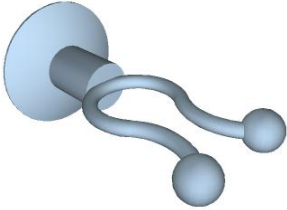
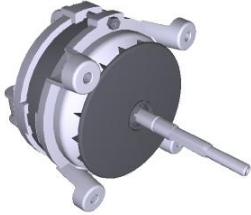

COMPONENT			SPARE PART																																																																																						
Code	Description	Image	Code	Description	Components list																																																																																				
GN1312A	RUBBER CABLE-PASSING DE=26 DI=15 SP=10		KVL0001A	LM TOP CLEANING SYSTEM KIT	<table border="1"> <thead> <tr> <th>Code</th> <th>Description</th> <th>Qty</th> <th>UOM</th> </tr> </thead> <tbody> <tr> <td>GN1312A0</td> <td>RUBBER CABLE-PASSI NG DE=26 DI=15 SP=10</td> <td>1</td> <td>PZ</td> </tr> <tr> <td>GN1526A0</td> <td>INT. D.=6.9 TH=1.8 O-RIN</td> <td>1</td> <td>PZ</td> </tr> <tr> <td>RC1019A0</td> <td>D=10 ELASTIC CLAMP</td> <td>5</td> <td>PZ</td> </tr> <tr> <td>RC1242A0</td> <td>D=10 CLOSED CAP</td> <td>2</td> <td>PZ</td> </tr> <tr> <td>RC1381A0</td> <td>BIFILAR PIPE CLIP D10.7</td> <td>3</td> <td>PZ</td> </tr> <tr> <td>TB2343A0</td> <td>9X6 PVC TRANSPAREN T PIPE</td> <td>1.650</td> <td>M</td> </tr> <tr> <td>TB2820A0</td> <td>6X10 EPDM PIPE FOR WASHING SYSTEM</td> <td>0.990</td> <td>M</td> </tr> <tr> <td>V11220A1</td> <td>4,2X12 TCB SELF-TAPPIN G SCREW</td> <td>1</td> <td>PZ</td> </tr> <tr> <td>VL1019A0</td> <td>VIBRATION PUMP</td> <td>1</td> <td>PZ</td> </tr> <tr> <td>VL1041C0</td> <td>DETERGENT CAP WITH Ø12 HOLE</td> <td>1</td> <td>PZ</td> </tr> <tr> <td>VL1047A1</td> <td>D6 PIPE HOLDER - D8 J.G. TERMINAL</td> <td>1</td> <td>PZ</td> </tr> <tr> <td>VL1053B0</td> <td>ONE WASHING SYS EXT DISTRIBUTOR</td> <td>1</td> <td>PZ</td> </tr> <tr> <td>VL1054B0</td> <td>ONE WASHING SYS INLET DISTRIBUTOR</td> <td>1</td> <td>PZ</td> </tr> <tr> <td>VL1061A0</td> <td>HOLD DOWN WEIGHT+NET FILTER+NON- RET. V.</td> <td>1</td> <td>PZ</td> </tr> <tr> <td>VL1128A0</td> <td>D6 BARBED CHECK VALVE</td> <td>2</td> <td>PZ</td> </tr> <tr> <td>VL1128A1</td> <td>D6 BARBED CHECK VALVE</td> <td>2</td> <td>PZ</td> </tr> <tr> <td>VM1066A0</td> <td>SADDLE CLIP FOR CABLES PASSING</td> <td>3</td> <td>PZ</td> </tr> <tr> <td>VM1088A0</td> <td>NYLON CLICK CLAMP D7.9-D9.2</td> <td>1</td> <td>PZ</td> </tr> <tr> <td>VM1605A0</td> <td>CLIP TWIST LOCK DIAM. 10.2-12.7 MM</td> <td>1</td> <td>PZ</td> </tr> <tr> <td>VM2172A0</td> <td>PUMP-WITH-CI RCUIT LOCKING PIN</td> <td>1</td> <td>PZ</td> </tr> </tbody> </table>	Code	Description	Qty	UOM	GN1312A0	RUBBER CABLE-PASSI NG DE=26 DI=15 SP=10	1	PZ	GN1526A0	INT. D.=6.9 TH=1.8 O-RIN	1	PZ	RC1019A0	D=10 ELASTIC CLAMP	5	PZ	RC1242A0	D=10 CLOSED CAP	2	PZ	RC1381A0	BIFILAR PIPE CLIP D10.7	3	PZ	TB2343A0	9X6 PVC TRANSPAREN T PIPE	1.650	M	TB2820A0	6X10 EPDM PIPE FOR WASHING SYSTEM	0.990	M	V11220A1	4,2X12 TCB SELF-TAPPIN G SCREW	1	PZ	VL1019A0	VIBRATION PUMP	1	PZ	VL1041C0	DETERGENT CAP WITH Ø12 HOLE	1	PZ	VL1047A1	D6 PIPE HOLDER - D8 J.G. TERMINAL	1	PZ	VL1053B0	ONE WASHING SYS EXT DISTRIBUTOR	1	PZ	VL1054B0	ONE WASHING SYS INLET DISTRIBUTOR	1	PZ	VL1061A0	HOLD DOWN WEIGHT+NET FILTER+NON- RET. V.	1	PZ	VL1128A0	D6 BARBED CHECK VALVE	2	PZ	VL1128A1	D6 BARBED CHECK VALVE	2	PZ	VM1066A0	SADDLE CLIP FOR CABLES PASSING	3	PZ	VM1088A0	NYLON CLICK CLAMP D7.9-D9.2	1	PZ	VM1605A0	CLIP TWIST LOCK DIAM. 10.2-12.7 MM	1	PZ	VM2172A0	PUMP-WITH-CI RCUIT LOCKING PIN	1	PZ
Code	Description	Qty	UOM																																																																																						
GN1312A0	RUBBER CABLE-PASSI NG DE=26 DI=15 SP=10	1	PZ																																																																																						
GN1526A0	INT. D.=6.9 TH=1.8 O-RIN	1	PZ																																																																																						
RC1019A0	D=10 ELASTIC CLAMP	5	PZ																																																																																						
RC1242A0	D=10 CLOSED CAP	2	PZ																																																																																						
RC1381A0	BIFILAR PIPE CLIP D10.7	3	PZ																																																																																						
TB2343A0	9X6 PVC TRANSPAREN T PIPE	1.650	M																																																																																						
TB2820A0	6X10 EPDM PIPE FOR WASHING SYSTEM	0.990	M																																																																																						
V11220A1	4,2X12 TCB SELF-TAPPIN G SCREW	1	PZ																																																																																						
VL1019A0	VIBRATION PUMP	1	PZ																																																																																						
VL1041C0	DETERGENT CAP WITH Ø12 HOLE	1	PZ																																																																																						
VL1047A1	D6 PIPE HOLDER - D8 J.G. TERMINAL	1	PZ																																																																																						
VL1053B0	ONE WASHING SYS EXT DISTRIBUTOR	1	PZ																																																																																						
VL1054B0	ONE WASHING SYS INLET DISTRIBUTOR	1	PZ																																																																																						
VL1061A0	HOLD DOWN WEIGHT+NET FILTER+NON- RET. V.	1	PZ																																																																																						
VL1128A0	D6 BARBED CHECK VALVE	2	PZ																																																																																						
VL1128A1	D6 BARBED CHECK VALVE	2	PZ																																																																																						
VM1066A0	SADDLE CLIP FOR CABLES PASSING	3	PZ																																																																																						
VM1088A0	NYLON CLICK CLAMP D7.9-D9.2	1	PZ																																																																																						
VM1605A0	CLIP TWIST LOCK DIAM. 10.2-12.7 MM	1	PZ																																																																																						
VM2172A0	PUMP-WITH-CI RCUIT LOCKING PIN	1	PZ																																																																																						

COMPONENT			SPARE PART																																														
Code	Description	Image	Code	Description	Components list																																												
VM1610A	CLIP TWIST LOCK DIAM. 7,6-10,2 MM		VM1605A0	CLIP TWIST LOCK DIAM. 10,2-12,7 MM																																													
MT1012A	330W 230V MOTOR		KVN1130A	LUX =08.2017/S.5/S.5E 330W MOTOR KIT	<table border="1"> <thead> <tr> <th>Code</th> <th>Description</th> <th>Qty</th> <th>UOM</th> </tr> </thead> <tbody> <tr> <td>0H4305A1</td> <td>ST. STEEL MOTOR SHAFT SEALING DISC</td> <td>1</td> <td>PZ</td> </tr> <tr> <td>GN1140A2</td> <td>MOTOR HOLDER GASKET</td> <td>1</td> <td>PZ</td> </tr> <tr> <td>GN1140A3</td> <td>MOLDED MOTOR HOLDER GASKET</td> <td>1</td> <td>PZ</td> </tr> <tr> <td>VI1045A0</td> <td>16X8,4 TH=1,6 ST.STEEL WASHER</td> <td>1</td> <td>PZ</td> </tr> <tr> <td>VI1256A0</td> <td>M8 DIN 980M ST. STEEL SELF LOCKING NUT</td> <td>1</td> <td>PZ</td> </tr> <tr> <td>VM1794A0</td> <td>250X4.8 PA66 BLACK CLAMP</td> <td>4</td> <td>PZ</td> </tr> <tr> <td>VM2103A0</td> <td>CLAMP LOCK</td> <td>4</td> <td>PZ</td> </tr> <tr> <td>VM2196A0</td> <td>MOTOR NUT FASTENING BUSHING</td> <td>1</td> <td>PZ</td> </tr> <tr> <td>VN1130A1</td> <td>330W 230V 50/60HZ MOTO</td> <td>1</td> <td>PZ</td> </tr> <tr> <td>VN1130A1</td> <td>330W 230V 50/60HZ MOTO</td> <td>1</td> <td>PZ</td> </tr> </tbody> </table>	Code	Description	Qty	UOM	0H4305A1	ST. STEEL MOTOR SHAFT SEALING DISC	1	PZ	GN1140A2	MOTOR HOLDER GASKET	1	PZ	GN1140A3	MOLDED MOTOR HOLDER GASKET	1	PZ	VI1045A0	16X8,4 TH=1,6 ST.STEEL WASHER	1	PZ	VI1256A0	M8 DIN 980M ST. STEEL SELF LOCKING NUT	1	PZ	VM1794A0	250X4.8 PA66 BLACK CLAMP	4	PZ	VM2103A0	CLAMP LOCK	4	PZ	VM2196A0	MOTOR NUT FASTENING BUSHING	1	PZ	VN1130A1	330W 230V 50/60HZ MOTO	1	PZ	VN1130A1	330W 230V 50/60HZ MOTO	1	PZ
Code	Description	Qty	UOM																																														
0H4305A1	ST. STEEL MOTOR SHAFT SEALING DISC	1	PZ																																														
GN1140A2	MOTOR HOLDER GASKET	1	PZ																																														
GN1140A3	MOLDED MOTOR HOLDER GASKET	1	PZ																																														
VI1045A0	16X8,4 TH=1,6 ST.STEEL WASHER	1	PZ																																														
VI1256A0	M8 DIN 980M ST. STEEL SELF LOCKING NUT	1	PZ																																														
VM1794A0	250X4.8 PA66 BLACK CLAMP	4	PZ																																														
VM2103A0	CLAMP LOCK	4	PZ																																														
VM2196A0	MOTOR NUT FASTENING BUSHING	1	PZ																																														
VN1130A1	330W 230V 50/60HZ MOTO	1	PZ																																														
VN1130A1	330W 230V 50/60HZ MOTO	1	PZ																																														
			KMT1012A	MIND.MAPS 330W 230V MOTOR KIT	<table border="1"> <thead> <tr> <th>Code</th> <th>Description</th> <th>Qty</th> <th>UOM</th> </tr> </thead> <tbody> <tr> <td>0H2842A0</td> <td>MT1012 CENTERING JI</td> <td>1</td> <td>PZ</td> </tr> <tr> <td>0H4305A1</td> <td>ST. STEEL MOTOR SHAFT SEALING DISC</td> <td>1</td> <td>PZ</td> </tr> <tr> <td>GN1140A2</td> <td>MOTOR HOLDER GASKET</td> <td>1</td> <td>PZ</td> </tr> <tr> <td>GN1140A3</td> <td>MOLDED MOTOR HOLDER GASKET</td> <td>1</td> <td>PZ</td> </tr> </tbody> </table>	Code	Description	Qty	UOM	0H2842A0	MT1012 CENTERING JI	1	PZ	0H4305A1	ST. STEEL MOTOR SHAFT SEALING DISC	1	PZ	GN1140A2	MOTOR HOLDER GASKET	1	PZ	GN1140A3	MOLDED MOTOR HOLDER GASKET	1	PZ																								
Code	Description	Qty	UOM																																														
0H2842A0	MT1012 CENTERING JI	1	PZ																																														
0H4305A1	ST. STEEL MOTOR SHAFT SEALING DISC	1	PZ																																														
GN1140A2	MOTOR HOLDER GASKET	1	PZ																																														
GN1140A3	MOLDED MOTOR HOLDER GASKET	1	PZ																																														





COMPONENT			SPARE PART																																										
Code	Description	Image	Code	Description	Components list																																								
MT1012A	330W 230V MOTOR		KMT1012A	MIND.MAPS 330W 230V MOTOR KIT	<table border="1"> <thead> <tr> <th>Code</th> <th>Description</th> <th>Qty</th> <th>UOM</th> </tr> </thead> <tbody> <tr> <td>MOV0007A0</td> <td>HOOD RING GASKET GN1110A2</td> <td>0.100</td> <td>PZ</td> </tr> <tr> <td>MT1012A0</td> <td>330W 230V MOTOR</td> <td>1</td> <td>PZ</td> </tr> <tr> <td>VE1550A0</td> <td>5X3 MM NEODYMIUM MAGNET</td> <td>1</td> <td>PZ</td> </tr> <tr> <td>VI1077A1</td> <td>SCREW M6X12 TE INOX</td> <td>1</td> <td>PZ</td> </tr> <tr> <td>VI1521A0</td> <td>STAINLESS STEEL WASHER D=6 6592</td> <td>1</td> <td>PZ</td> </tr> <tr> <td>VI1966A0</td> <td>M4X14 FLATHEAD SCREW</td> <td>1</td> <td>PZ</td> </tr> <tr> <td>VM1635A0</td> <td>MAGNET HOLDING DIS</td> <td>1</td> <td>PZ</td> </tr> <tr> <td>VM1794A0</td> <td>250X4.8 PA66 BLACK CLAMP</td> <td>4</td> <td>PZ</td> </tr> <tr> <td>VM2103A0</td> <td>CLAMP LOCK</td> <td>4</td> <td>PZ</td> </tr> </tbody> </table>	Code	Description	Qty	UOM	MOV0007A0	HOOD RING GASKET GN1110A2	0.100	PZ	MT1012A0	330W 230V MOTOR	1	PZ	VE1550A0	5X3 MM NEODYMIUM MAGNET	1	PZ	VI1077A1	SCREW M6X12 TE INOX	1	PZ	VI1521A0	STAINLESS STEEL WASHER D=6 6592	1	PZ	VI1966A0	M4X14 FLATHEAD SCREW	1	PZ	VM1635A0	MAGNET HOLDING DIS	1	PZ	VM1794A0	250X4.8 PA66 BLACK CLAMP	4	PZ	VM2103A0	CLAMP LOCK	4	PZ
					Code	Description	Qty	UOM																																					
					MOV0007A0	HOOD RING GASKET GN1110A2	0.100	PZ																																					
					MT1012A0	330W 230V MOTOR	1	PZ																																					
					VE1550A0	5X3 MM NEODYMIUM MAGNET	1	PZ																																					
					VI1077A1	SCREW M6X12 TE INOX	1	PZ																																					
					VI1521A0	STAINLESS STEEL WASHER D=6 6592	1	PZ																																					
					VI1966A0	M4X14 FLATHEAD SCREW	1	PZ																																					
					VM1635A0	MAGNET HOLDING DIS	1	PZ																																					
					VM1794A0	250X4.8 PA66 BLACK CLAMP	4	PZ																																					
VM2103A0	CLAMP LOCK	4	PZ																																										
GN1140A	MOTOR HOLDER GASKET		KGN1140A	5 PCS. MOTOR HOLDER GASKET KI	<table border="1"> <thead> <tr> <th>Code</th> <th>Description</th> <th>Qty</th> <th>UOM</th> </tr> </thead> <tbody> <tr> <td>GN1140A2</td> <td>MOTOR HOLDER GASKET</td> <td>5</td> <td>PZ</td> </tr> <tr> <td>GN1140A3</td> <td>MOLDED MOTOR HOLDER GASKET</td> <td>5</td> <td>PZ</td> </tr> <tr> <td>VM1224A0</td> <td>65MY 220MM 2 COLOURS SHRINK TUBE</td> <td>0.200</td> <td>M</td> </tr> </tbody> </table>	Code	Description	Qty	UOM	GN1140A2	MOTOR HOLDER GASKET	5	PZ	GN1140A3	MOLDED MOTOR HOLDER GASKET	5	PZ	VM1224A0	65MY 220MM 2 COLOURS SHRINK TUBE	0.200	M																								
					Code	Description	Qty	UOM																																					
					GN1140A2	MOTOR HOLDER GASKET	5	PZ																																					
GN1140A3	MOLDED MOTOR HOLDER GASKET	5	PZ																																										
VM1224A0	65MY 220MM 2 COLOURS SHRINK TUBE	0.200	M																																										
0H4305A	ST. STEEL MOTOR SHAFT SEALING DIS		K0H4305A	SEALING DISC FOR MOTOR SHAFT KIT	<table border="1"> <thead> <tr> <th>Code</th> <th>Description</th> <th>Qty</th> <th>UOM</th> </tr> </thead> <tbody> <tr> <td>0H4305A1</td> <td>ST. STEEL MOTOR SHAFT SEALING DISC</td> <td>1</td> <td>PZ</td> </tr> <tr> <td>GN1140A2</td> <td>MOTOR HOLDER GASKET</td> <td>1</td> <td>PZ</td> </tr> <tr> <td>GN1140A3</td> <td>MOLDED MOTOR HOLDER GASKET</td> <td>1</td> <td>PZ</td> </tr> <tr> <td>SL1045A0</td> <td>S57 BLACK SILICONE - 80ML CARTRIDGE</td> <td>1</td> <td>PZ</td> </tr> <tr> <td>VI1220A1</td> <td>4,2X12 TCB SELF-TAPPIN G SCREW</td> <td>3</td> <td>PZ</td> </tr> </tbody> </table>	Code	Description	Qty	UOM	0H4305A1	ST. STEEL MOTOR SHAFT SEALING DISC	1	PZ	GN1140A2	MOTOR HOLDER GASKET	1	PZ	GN1140A3	MOLDED MOTOR HOLDER GASKET	1	PZ	SL1045A0	S57 BLACK SILICONE - 80ML CARTRIDGE	1	PZ	VI1220A1	4,2X12 TCB SELF-TAPPIN G SCREW	3	PZ																
					Code	Description	Qty	UOM																																					
					0H4305A1	ST. STEEL MOTOR SHAFT SEALING DISC	1	PZ																																					
					GN1140A2	MOTOR HOLDER GASKET	1	PZ																																					
					GN1140A3	MOLDED MOTOR HOLDER GASKET	1	PZ																																					
SL1045A0	S57 BLACK SILICONE - 80ML CARTRIDGE	1	PZ																																										
VI1220A1	4,2X12 TCB SELF-TAPPIN G SCREW	3	PZ																																										



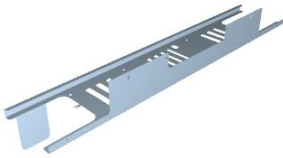
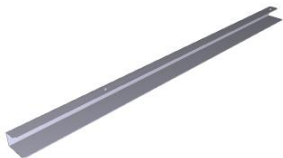
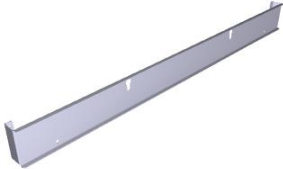

COMPONENT			SPARE PART																						
Code	Description	Image	Code	Description	Components list																				
VN1181A	M6 NUT 39 BLADES H81 D196 FAN		KVN1181A	D196 H81 39 BLADES FAN+SCREW M6 KIT	<table border="1"> <thead> <tr> <th>Code</th> <th>Description</th> <th>Qty</th> <th>UOM</th> </tr> </thead> <tbody> <tr> <td>VI1077A1</td> <td>SCREW M6X12 TE INOX</td> <td>1</td> <td>PZ</td> </tr> <tr> <td>VI1521A0</td> <td>STAINLESS STEEL WASHER D=6 6592</td> <td>1</td> <td>PZ</td> </tr> <tr> <td>VN1181A0</td> <td>M6 NUT 39 BLADES H81 D196 FAN</td> <td>1</td> <td>PZ</td> </tr> <tr> <td>VN1181A0</td> <td>M6 NUT 39 BLADES H81 D196 FAN</td> <td>1</td> <td>PZ</td> </tr> </tbody> </table>	Code	Description	Qty	UOM	VI1077A1	SCREW M6X12 TE INOX	1	PZ	VI1521A0	STAINLESS STEEL WASHER D=6 6592	1	PZ	VN1181A0	M6 NUT 39 BLADES H81 D196 FAN	1	PZ	VN1181A0	M6 NUT 39 BLADES H81 D196 FAN	1	PZ
			Code	Description	Qty	UOM																			
VI1077A1	SCREW M6X12 TE INOX	1	PZ																						
VI1521A0	STAINLESS STEEL WASHER D=6 6592	1	PZ																						
VN1181A0	M6 NUT 39 BLADES H81 D196 FAN	1	PZ																						
VN1181A0	M6 NUT 39 BLADES H81 D196 FAN	1	PZ																						
KVN1030A	LUX =08.2017S.5/S.5E D196 FAN KIT	<table border="1"> <thead> <tr> <th>Code</th> <th>Description</th> <th>Qty</th> <th>UOM</th> </tr> </thead> <tbody> <tr> <td>VI1256A0</td> <td>M8 DIN 980M ST. STEEL SELF LOCKING NUT</td> <td>1</td> <td>PZ</td> </tr> <tr> <td>VM2196A0</td> <td>MOTOR NUT FASTENING BUSHING</td> <td>1</td> <td>PZ</td> </tr> <tr> <td>VN1030A5</td> <td>Ø196 H81 38 BLADES MOTOR FAN</td> <td>1</td> <td>PZ</td> </tr> <tr> <td>VN1030A5</td> <td>Ø196 H81 38 BLADES MOTOR FAN</td> <td>1</td> <td>PZ</td> </tr> </tbody> </table>	Code	Description	Qty	UOM	VI1256A0	M8 DIN 980M ST. STEEL SELF LOCKING NUT	1	PZ	VM2196A0	MOTOR NUT FASTENING BUSHING	1	PZ	VN1030A5	Ø196 H81 38 BLADES MOTOR FAN	1	PZ	VN1030A5	Ø196 H81 38 BLADES MOTOR FAN	1	PZ			
Code	Description	Qty	UOM																						
VI1256A0	M8 DIN 980M ST. STEEL SELF LOCKING NUT	1	PZ																						
VM2196A0	MOTOR NUT FASTENING BUSHING	1	PZ																						
VN1030A5	Ø196 H81 38 BLADES MOTOR FAN	1	PZ																						
VN1030A5	Ø196 H81 38 BLADES MOTOR FAN	1	PZ																						
TB1515A	EXTERNAL HUMIDITY PIPE + RC1165A0		TB1515A1	EXTERNAL HUMIDITY PIPE + RC1165A0																					
0H6334A	BL CL COOKING CHAMBER HOLDING BRACKET		0H6334A0	BL CL COOKING CHAMBER HOLDING BRACKET																					

COMPONENT			SPARE PART																										
Code	Description	Image	Code	Description	Components list																								
RS1261A	BAKERLUX\CHEFLUX MOTOR BREAKING ELEMEN		KRS1261A	122W MOTOR BREAKING ELEMENT KIT	<table border="1"> <thead> <tr> <th>Code</th> <th>Description</th> <th>Qty</th> <th>UOM</th> </tr> </thead> <tbody> <tr> <td>GN1326A1</td> <td>ELEMENT SEALING</td> <td>1</td> <td>PZ</td> </tr> <tr> <td>RS1261A0</td> <td>BAKERLUX\CH EFLUX MOTOR BREAKING ELEMENT</td> <td>1</td> <td>PZ</td> </tr> <tr> <td>SL1045A0</td> <td>S57 BLACK SILICONE - 80ML CARTRIDGE</td> <td>1</td> <td>PZ</td> </tr> <tr> <td>VI1220A1</td> <td>4,2X12 TCB SELF-TAPPING SCREW</td> <td>2</td> <td>PZ</td> </tr> <tr> <td>VM2147A0</td> <td>410X343X15 MM PINK SMOOTH ESD SPONGE</td> <td>1</td> <td>PZ</td> </tr> </tbody> </table>	Code	Description	Qty	UOM	GN1326A1	ELEMENT SEALING	1	PZ	RS1261A0	BAKERLUX\CH EFLUX MOTOR BREAKING ELEMENT	1	PZ	SL1045A0	S57 BLACK SILICONE - 80ML CARTRIDGE	1	PZ	VI1220A1	4,2X12 TCB SELF-TAPPING SCREW	2	PZ	VM2147A0	410X343X15 MM PINK SMOOTH ESD SPONGE	1	PZ
Code	Description	Qty	UOM																										
GN1326A1	ELEMENT SEALING	1	PZ																										
RS1261A0	BAKERLUX\CH EFLUX MOTOR BREAKING ELEMENT	1	PZ																										
SL1045A0	S57 BLACK SILICONE - 80ML CARTRIDGE	1	PZ																										
VI1220A1	4,2X12 TCB SELF-TAPPING SCREW	2	PZ																										
VM2147A0	410X343X15 MM PINK SMOOTH ESD SPONGE	1	PZ																										
VM1820A	LATERAL SUPPORTS M6 FIXING BOLT		KVM1820A	THUMB SCREW 10PCS KIT	<table border="1"> <thead> <tr> <th>Code</th> <th>Description</th> <th>Qty</th> <th>UOM</th> </tr> </thead> <tbody> <tr> <td>VM1224A0</td> <td>65MY 220MM COLOURS SHRINK TUBE</td> <td>0.200</td> <td>M</td> </tr> <tr> <td>VM1820A0</td> <td>LATERAL SUPPORTS M6 FIXING BOLT</td> <td>10</td> <td>PZ</td> </tr> </tbody> </table>	Code	Description	Qty	UOM	VM1224A0	65MY 220MM COLOURS SHRINK TUBE	0.200	M	VM1820A0	LATERAL SUPPORTS M6 FIXING BOLT	10	PZ												
Code	Description	Qty	UOM																										
VM1224A0	65MY 220MM COLOURS SHRINK TUBE	0.200	M																										
VM1820A0	LATERAL SUPPORTS M6 FIXING BOLT	10	PZ																										
GRL1265A	LEFT LATERAL SUPPORT 10 600X40		KGRL1265A	10TRAYS 60X40 LATERAL SUPPORT KIT	<table border="1"> <thead> <tr> <th>Code</th> <th>Description</th> <th>Qty</th> <th>UOM</th> </tr> </thead> <tbody> <tr> <td>0H4215A0</td> <td>TRAYS GUIDE PROFILE L372.5 BT</td> <td>20</td> <td>PZ</td> </tr> <tr> <td>0H4420A0</td> <td>STAINLESS STEEL CORE TEMPERATUR</td> <td>1</td> <td>PZ</td> </tr> <tr> <td>0H6709A1</td> <td>0H6495A+0H6 496A FLAT SUPPORTING PROFILE</td> <td>2</td> <td>PZ</td> </tr> <tr> <td>0H6710A1</td> <td>0H6497A+0H6 498A FLAT SUPPORTING PROFILE</td> <td>2</td> <td>PZ</td> </tr> </tbody> </table>	Code	Description	Qty	UOM	0H4215A0	TRAYS GUIDE PROFILE L372.5 BT	20	PZ	0H4420A0	STAINLESS STEEL CORE TEMPERATUR	1	PZ	0H6709A1	0H6495A+0H6 496A FLAT SUPPORTING PROFILE	2	PZ	0H6710A1	0H6497A+0H6 498A FLAT SUPPORTING PROFILE	2	PZ				
Code	Description	Qty	UOM																										
0H4215A0	TRAYS GUIDE PROFILE L372.5 BT	20	PZ																										
0H4420A0	STAINLESS STEEL CORE TEMPERATUR	1	PZ																										
0H6709A1	0H6495A+0H6 496A FLAT SUPPORTING PROFILE	2	PZ																										
0H6710A1	0H6497A+0H6 498A FLAT SUPPORTING PROFILE	2	PZ																										
GRL1266A	RIGHT LATERAL SUPPORT 10 600X40		KGRL1265A	10TRAYS 60X40 LATERAL SUPPORT KIT	<table border="1"> <thead> <tr> <th>Code</th> <th>Description</th> <th>Qty</th> <th>UOM</th> </tr> </thead> <tbody> <tr> <td>0H4215A0</td> <td>TRAYS GUIDE PROFILE L372.5 BT</td> <td>20</td> <td>PZ</td> </tr> <tr> <td>0H4420A0</td> <td>STAINLESS STEEL CORE TEMPERATUR</td> <td>1</td> <td>PZ</td> </tr> </tbody> </table>	Code	Description	Qty	UOM	0H4215A0	TRAYS GUIDE PROFILE L372.5 BT	20	PZ	0H4420A0	STAINLESS STEEL CORE TEMPERATUR	1	PZ												
Code	Description	Qty	UOM																										
0H4215A0	TRAYS GUIDE PROFILE L372.5 BT	20	PZ																										
0H4420A0	STAINLESS STEEL CORE TEMPERATUR	1	PZ																										



COMPONENT			SPARE PART														
Code	Description	Image	Code	Description	Components list												
GRL1266A	RIGHT LATERAL SUPPORT 10 600X40		KGRL1265A	10TRAYS 60X40 LATERAL SUPPORT KIT	<table border="1"> <thead> <tr> <th>Code</th> <th>Description</th> <th>Qty</th> <th>UOM</th> </tr> </thead> <tbody> <tr> <td>0H6709A1</td> <td>0H6495A+0H6 496A FLAT SUPPORTING PROFILE</td> <td>2</td> <td>PZ</td> </tr> <tr> <td>0H6710A1</td> <td>0H6497A+0H6 498A FLAT SUPPORTING PROFILE</td> <td>2</td> <td>PZ</td> </tr> </tbody> </table>	Code	Description	Qty	UOM	0H6709A1	0H6495A+0H6 496A FLAT SUPPORTING PROFILE	2	PZ	0H6710A1	0H6497A+0H6 498A FLAT SUPPORTING PROFILE	2	PZ
Code	Description	Qty	UOM														
0H6709A1	0H6495A+0H6 496A FLAT SUPPORTING PROFILE	2	PZ														
0H6710A1	0H6497A+0H6 498A FLAT SUPPORTING PROFILE	2	PZ														
TB2191A	XB89- XV89- Ø16X1 INTERNAL HUMIDITY PIPE		TB2191A0	XB89- XV89- Ø16X1 INTERNAL HUMIDITY PIPE													
0H6568C	LUX BURNER SUPPORT PLATE		0H6568C0	LUX BURNER SUPPORT PLATE													
0H4075A	XBC614/814G GLASS WOOL PRESS PLATE		0H4075A0	XBC614/814G GLASS WOOL PRESS PLATE													
0H6573A	BURNER LOWER HOLDING PANEL		0H6573A0	BURNER LOWER HOLDING PANEL													



COMPONENT			SPARE PART														
Code	Description	Image	Code	Description	Components list												
0H6711B	EXHAUST FUMES THERMOSTAT SUPPORT		0H6711B0	EXHAUST FUMES THERMOSTAT SUPPORT													
0N1135A	GAS BAFFLE FORK		0N1135A2	GAS BAFFLE FORK													
0G1517B	XB813G XV813G FAN GUARD		0G1517B0	XB813G XV813G FAN GUARD													
0G1330A	XBC GAS SERIE ST. STEEL FAN GUARD SPACER		0G1330A2	XBC GAS SERIE ST. STEEL FAN GUARD SPACER													
EL1252A	1 WAY WATER VALVE + J.G. CONNECTION		KEL1252A	EL2 JG D8-D10 1 WAY SOLENOID VALVE KIT	<table border="1"> <thead> <tr> <th>Code</th> <th>Description</th> <th>Qty</th> <th>UOM</th> </tr> </thead> <tbody> <tr> <td>EL1252A1</td> <td>1 WAY WATER VALVE + J.G. CONNECTION</td> <td>1</td> <td>PZ</td> </tr> <tr> <td>VM1224A0</td> <td>65MY 220MM 2 COLOURS SHRINK TUBE</td> <td>0.250</td> <td>M</td> </tr> </tbody> </table>	Code	Description	Qty	UOM	EL1252A1	1 WAY WATER VALVE + J.G. CONNECTION	1	PZ	VM1224A0	65MY 220MM 2 COLOURS SHRINK TUBE	0.250	M
Code	Description	Qty	UOM														
EL1252A1	1 WAY WATER VALVE + J.G. CONNECTION	1	PZ														
VM1224A0	65MY 220MM 2 COLOURS SHRINK TUBE	0.250	M														

COMPONENT			SPARE PART																														
Code	Description	Image	Code	Description	Components list																												
VM1465A	CT BT TEMPERATURE PROBE COVER		KTR1150B	PT1000 L1200 TEMPERATURE PROBE KIT	<table border="1"> <thead> <tr> <th>Code</th> <th>Description</th> <th>Qty</th> <th>UOM</th> </tr> </thead> <tbody> <tr> <td>GN1285A0</td> <td>NTC TEMPERATUR E PROBE SEALING</td> <td>1</td> <td>PZ</td> </tr> <tr> <td>TR1150B0</td> <td></td> <td>1</td> <td>PZ</td> </tr> <tr> <td>TR1150B1</td> <td></td> <td>1</td> <td>PZ</td> </tr> <tr> <td>VI1220A1</td> <td>4,2X12 TCB SELF-TAPPIN G SCREW</td> <td>1</td> <td>PZ</td> </tr> <tr> <td>VM1465A0</td> <td>CHEFTOP TEMPERATUR E PROBE COVER</td> <td>1</td> <td>PZ</td> </tr> <tr> <td>VM1465A1</td> <td>CT BT TEMPERATUR E PROBE COVER</td> <td>1</td> <td>PZ</td> </tr> </tbody> </table>	Code	Description	Qty	UOM	GN1285A0	NTC TEMPERATUR E PROBE SEALING	1	PZ	TR1150B0		1	PZ	TR1150B1		1	PZ	VI1220A1	4,2X12 TCB SELF-TAPPIN G SCREW	1	PZ	VM1465A0	CHEFTOP TEMPERATUR E PROBE COVER	1	PZ	VM1465A1	CT BT TEMPERATUR E PROBE COVER	1	PZ
			Code	Description	Qty	UOM																											
			GN1285A0	NTC TEMPERATUR E PROBE SEALING	1	PZ																											
TR1150B0		1	PZ																														
TR1150B1		1	PZ																														
VI1220A1	4,2X12 TCB SELF-TAPPIN G SCREW	1	PZ																														
VM1465A0	CHEFTOP TEMPERATUR E PROBE COVER	1	PZ																														
VM1465A1	CT BT TEMPERATUR E PROBE COVER	1	PZ																														
KTR1150A	EVEREO PT100 L2000 TEMPERATURE PROBE KIT	<table border="1"> <thead> <tr> <th>Code</th> <th>Description</th> <th>Qty</th> <th>UOM</th> </tr> </thead> <tbody> <tr> <td>CE1880A0</td> <td>CPM 4P 3P81 CONNECTION CABLE EXIT 90</td> <td>1</td> <td>PZ</td> </tr> <tr> <td>GN1285A0</td> <td>NTC TEMPERATUR E PROBE SEALING</td> <td>1</td> <td>PZ</td> </tr> <tr> <td>TR1150A0</td> <td>PT100 3F L2000 TEMPERATUR E PROBE</td> <td>1</td> <td>PZ</td> </tr> <tr> <td>VM1465A0</td> <td>CHEFTOP TEMPERATUR E PROBE COVER</td> <td>1</td> <td>PZ</td> </tr> <tr> <td>VM1465A1</td> <td>CT BT TEMPERATUR E PROBE COVER</td> <td>1</td> <td>PZ</td> </tr> </tbody> </table>	Code	Description	Qty	UOM	CE1880A0	CPM 4P 3P81 CONNECTION CABLE EXIT 90	1	PZ	GN1285A0	NTC TEMPERATUR E PROBE SEALING	1	PZ	TR1150A0	PT100 3F L2000 TEMPERATUR E PROBE	1	PZ	VM1465A0	CHEFTOP TEMPERATUR E PROBE COVER	1	PZ	VM1465A1	CT BT TEMPERATUR E PROBE COVER	1	PZ							
Code	Description	Qty	UOM																														
CE1880A0	CPM 4P 3P81 CONNECTION CABLE EXIT 90	1	PZ																														
GN1285A0	NTC TEMPERATUR E PROBE SEALING	1	PZ																														
TR1150A0	PT100 3F L2000 TEMPERATUR E PROBE	1	PZ																														
VM1465A0	CHEFTOP TEMPERATUR E PROBE COVER	1	PZ																														
VM1465A1	CT BT TEMPERATUR E PROBE COVER	1	PZ																														
KTR1106B	MIND.MAPS L2000 CHAMBER TEMP. PROBE KIT	<table border="1"> <thead> <tr> <th>Code</th> <th>Description</th> <th>Qty</th> <th>UOM</th> </tr> </thead> <tbody> <tr> <td>GN1285A0</td> <td>NTC TEMPERATUR E PROBE SEALING</td> <td>1</td> <td>PZ</td> </tr> <tr> <td>SL1045A0</td> <td>S57 BLACK SILICONE - 80ML CARTRIDGE</td> <td>1</td> <td>PZ</td> </tr> <tr> <td>TR1106B0</td> <td></td> <td>1</td> <td>PZ</td> </tr> <tr> <td>VI1220A1</td> <td>4,2X12 TCB SELF-TAPPIN G SCREW</td> <td>2</td> <td>PZ</td> </tr> </tbody> </table>	Code	Description	Qty	UOM	GN1285A0	NTC TEMPERATUR E PROBE SEALING	1	PZ	SL1045A0	S57 BLACK SILICONE - 80ML CARTRIDGE	1	PZ	TR1106B0		1	PZ	VI1220A1	4,2X12 TCB SELF-TAPPIN G SCREW	2	PZ											
Code	Description	Qty	UOM																														
GN1285A0	NTC TEMPERATUR E PROBE SEALING	1	PZ																														
SL1045A0	S57 BLACK SILICONE - 80ML CARTRIDGE	1	PZ																														
TR1106B0		1	PZ																														
VI1220A1	4,2X12 TCB SELF-TAPPIN G SCREW	2	PZ																														



COMPONENT			SPARE PART																											
Code	Description	Image	Code	Description	Components list																									
VM1465A	CT BT TEMPERATURE PROBE COVER		KTR1106B	MIND.MAPS L2000 CHAMBER TEMP. PROBE KIT	<table border="1"> <thead> <tr> <th>Code</th> <th>Description</th> <th>Qty</th> <th>UOM</th> </tr> </thead> <tbody> <tr> <td>VM1464A1</td> <td>CT BT TEMPERATUR E PROBE COVER</td> <td>1</td> <td>PZ</td> </tr> <tr> <td>VM1465A0</td> <td>CHEFTOP TEMPERATUR E PROBE COVER</td> <td>1</td> <td>PZ</td> </tr> <tr> <td>VM1465A1</td> <td>CT BT TEMPERATUR E PROBE COVER</td> <td>1</td> <td>PZ</td> </tr> </tbody> </table>	Code	Description	Qty	UOM	VM1464A1	CT BT TEMPERATUR E PROBE COVER	1	PZ	VM1465A0	CHEFTOP TEMPERATUR E PROBE COVER	1	PZ	VM1465A1	CT BT TEMPERATUR E PROBE COVER	1	PZ									
			Code	Description	Qty	UOM																								
			VM1464A1	CT BT TEMPERATUR E PROBE COVER	1	PZ																								
VM1465A0	CHEFTOP TEMPERATUR E PROBE COVER	1	PZ																											
VM1465A1	CT BT TEMPERATUR E PROBE COVER	1	PZ																											
KTR1106A	5-5E S. L2000 CHAMBER TEMP. PROBE KIT	<table border="1"> <thead> <tr> <th>Code</th> <th>Description</th> <th>Qty</th> <th>UOM</th> </tr> </thead> <tbody> <tr> <td>GN1285A0</td> <td>NTC TEMPERATUR E PROBE SEALING</td> <td>1</td> <td>PZ</td> </tr> <tr> <td>SL1045A0</td> <td>S57 BLACK SILICONE - 80ML CARTRIDGE</td> <td>1</td> <td>PZ</td> </tr> <tr> <td>TR1106A3</td> <td>PT100 L=2000 TEMPERATUR E PROBE</td> <td>1</td> <td>PZ</td> </tr> <tr> <td>VI1220A1</td> <td>4,2X12 TCB SELF-TAPPIN G SCREW</td> <td>2</td> <td>PZ</td> </tr> <tr> <td>VM1465A0</td> <td>CHEFTOP TEMPERATUR E PROBE COVER</td> <td>1</td> <td>PZ</td> </tr> <tr> <td>VM1465A1</td> <td>CT BT TEMPERATUR E PROBE COVER</td> <td>1</td> <td>PZ</td> </tr> </tbody> </table>	Code	Description	Qty	UOM	GN1285A0	NTC TEMPERATUR E PROBE SEALING	1	PZ	SL1045A0	S57 BLACK SILICONE - 80ML CARTRIDGE	1	PZ	TR1106A3	PT100 L=2000 TEMPERATUR E PROBE	1	PZ	VI1220A1	4,2X12 TCB SELF-TAPPIN G SCREW	2	PZ	VM1465A0	CHEFTOP TEMPERATUR E PROBE COVER	1	PZ	VM1465A1	CT BT TEMPERATUR E PROBE COVER	1	PZ
Code	Description	Qty	UOM																											
GN1285A0	NTC TEMPERATUR E PROBE SEALING	1	PZ																											
SL1045A0	S57 BLACK SILICONE - 80ML CARTRIDGE	1	PZ																											
TR1106A3	PT100 L=2000 TEMPERATUR E PROBE	1	PZ																											
VI1220A1	4,2X12 TCB SELF-TAPPIN G SCREW	2	PZ																											
VM1465A0	CHEFTOP TEMPERATUR E PROBE COVER	1	PZ																											
VM1465A1	CT BT TEMPERATUR E PROBE COVER	1	PZ																											
KTR1105A	PT100 L1000 TEMPERATURE PROBE KIT	<table border="1"> <thead> <tr> <th>Code</th> <th>Description</th> <th>Qty</th> <th>UOM</th> </tr> </thead> <tbody> <tr> <td>GN1120A0</td> <td>NTC TEMPERATUR E PROBE SEAL</td> <td>1</td> <td>PZ</td> </tr> <tr> <td>GN1120A1</td> <td>NTC TEMPERATUR E PROBE SEAL</td> <td>1</td> <td>PZ</td> </tr> <tr> <td>GN1285A0</td> <td>NTC TEMPERATUR E PROBE SEALING</td> <td>1</td> <td>PZ</td> </tr> <tr> <td>MOV0010A0</td> <td>HOOD RING GASKET GN1110A2</td> <td>0.100</td> <td>PZ</td> </tr> <tr> <td>SL1045A0</td> <td>S57 BLACK SILICONE - 80ML CARTRIDGE</td> <td>1</td> <td>PZ</td> </tr> </tbody> </table>	Code	Description	Qty	UOM	GN1120A0	NTC TEMPERATUR E PROBE SEAL	1	PZ	GN1120A1	NTC TEMPERATUR E PROBE SEAL	1	PZ	GN1285A0	NTC TEMPERATUR E PROBE SEALING	1	PZ	MOV0010A0	HOOD RING GASKET GN1110A2	0.100	PZ	SL1045A0	S57 BLACK SILICONE - 80ML CARTRIDGE	1	PZ				
Code	Description	Qty	UOM																											
GN1120A0	NTC TEMPERATUR E PROBE SEAL	1	PZ																											
GN1120A1	NTC TEMPERATUR E PROBE SEAL	1	PZ																											
GN1285A0	NTC TEMPERATUR E PROBE SEALING	1	PZ																											
MOV0010A0	HOOD RING GASKET GN1110A2	0.100	PZ																											
SL1045A0	S57 BLACK SILICONE - 80ML CARTRIDGE	1	PZ																											





COMPONENT			SPARE PART																																			
Code	Description	Image	Code	Description	Components list																																	
VM1465A	CT BT TEMPERATURE PROBE COVER		KTR1105A	PT100 L1000 TEMPERATURE PROBE KIT	<table border="1"> <thead> <tr> <th>Code</th> <th>Description</th> <th>Qty</th> <th>UOM</th> </tr> </thead> <tbody> <tr> <td>TR1105A4</td> <td>L1000 PT100 TEMPERATUR E PROBE</td> <td>1</td> <td>PZ</td> </tr> <tr> <td>VI1220A1</td> <td>4,2X12 TCB SELF-TAPPIN G SCREW</td> <td>2</td> <td>PZ</td> </tr> <tr> <td>VM1464A1</td> <td>CT BT TEMPERATUR E PROBE COVER</td> <td>1</td> <td>PZ</td> </tr> <tr> <td>VM1465A1</td> <td>CT BT TEMPERATUR E PROBE COVER</td> <td>1</td> <td>PZ</td> </tr> <tr> <td>VM2052A0</td> <td>LM CORE PROBE COVE</td> <td>1</td> <td>PZ</td> </tr> </tbody> </table>	Code	Description	Qty	UOM	TR1105A4	L1000 PT100 TEMPERATUR E PROBE	1	PZ	VI1220A1	4,2X12 TCB SELF-TAPPIN G SCREW	2	PZ	VM1464A1	CT BT TEMPERATUR E PROBE COVER	1	PZ	VM1465A1	CT BT TEMPERATUR E PROBE COVER	1	PZ	VM2052A0	LM CORE PROBE COVE	1	PZ									
			Code	Description	Qty	UOM																																
			TR1105A4	L1000 PT100 TEMPERATUR E PROBE	1	PZ																																
VI1220A1	4,2X12 TCB SELF-TAPPIN G SCREW	2	PZ																																			
VM1464A1	CT BT TEMPERATUR E PROBE COVER	1	PZ																																			
VM1465A1	CT BT TEMPERATUR E PROBE COVER	1	PZ																																			
VM2052A0	LM CORE PROBE COVE	1	PZ																																			
KTR1096A	NTC 150 L=1500 TEMPERATURE PROBE KIT	<table border="1"> <thead> <tr> <th>Code</th> <th>Description</th> <th>Qty</th> <th>UOM</th> </tr> </thead> <tbody> <tr> <td>GN1120A0</td> <td>NTC TEMPERATUR E PROBE SEAL</td> <td>1</td> <td>PZ</td> </tr> <tr> <td>GN1120A1</td> <td>NTC TEMPERATUR E PROBE SEAL</td> <td>1</td> <td>PZ</td> </tr> <tr> <td>GN1285A0</td> <td>NTC TEMPERATUR E PROBE SEALING</td> <td>2</td> <td>PZ</td> </tr> <tr> <td>SL1045A0</td> <td>S57 BLACK SILICONE - 80ML CARTRIDGE</td> <td>1</td> <td>PZ</td> </tr> <tr> <td>TR1096A0</td> <td>TEMPERATUR E PROBE NTC 150 L=1500</td> <td>1</td> <td>PZ</td> </tr> <tr> <td>VI1220A1</td> <td>4,2X12 TCB SELF-TAPPIN G SCREW</td> <td>2</td> <td>PZ</td> </tr> <tr> <td>VM1465A0</td> <td>CHEFTOP TEMPERATUR E PROBE COVER</td> <td>1</td> <td>PZ</td> </tr> <tr> <td>VM1465A1</td> <td>CT BT TEMPERATUR E PROBE COVER</td> <td>1</td> <td>PZ</td> </tr> </tbody> </table>	Code	Description	Qty	UOM	GN1120A0	NTC TEMPERATUR E PROBE SEAL	1	PZ	GN1120A1	NTC TEMPERATUR E PROBE SEAL	1	PZ	GN1285A0	NTC TEMPERATUR E PROBE SEALING	2	PZ	SL1045A0	S57 BLACK SILICONE - 80ML CARTRIDGE	1	PZ	TR1096A0	TEMPERATUR E PROBE NTC 150 L=1500	1	PZ	VI1220A1	4,2X12 TCB SELF-TAPPIN G SCREW	2	PZ	VM1465A0	CHEFTOP TEMPERATUR E PROBE COVER	1	PZ	VM1465A1	CT BT TEMPERATUR E PROBE COVER	1	PZ
Code	Description	Qty	UOM																																			
GN1120A0	NTC TEMPERATUR E PROBE SEAL	1	PZ																																			
GN1120A1	NTC TEMPERATUR E PROBE SEAL	1	PZ																																			
GN1285A0	NTC TEMPERATUR E PROBE SEALING	2	PZ																																			
SL1045A0	S57 BLACK SILICONE - 80ML CARTRIDGE	1	PZ																																			
TR1096A0	TEMPERATUR E PROBE NTC 150 L=1500	1	PZ																																			
VI1220A1	4,2X12 TCB SELF-TAPPIN G SCREW	2	PZ																																			
VM1465A0	CHEFTOP TEMPERATUR E PROBE COVER	1	PZ																																			
VM1465A1	CT BT TEMPERATUR E PROBE COVER	1	PZ																																			
KTR1095A	NTC 150 L=1050 TEMPERATURE PROBE KIT	<table border="1"> <thead> <tr> <th>Code</th> <th>Description</th> <th>Qty</th> <th>UOM</th> </tr> </thead> <tbody> <tr> <td>GN1120A0</td> <td>NTC TEMPERATUR E PROBE SEAL</td> <td>1</td> <td>PZ</td> </tr> <tr> <td>GN1120A1</td> <td>NTC TEMPERATUR E PROBE SEAL</td> <td>1</td> <td>PZ</td> </tr> </tbody> </table>	Code	Description	Qty	UOM	GN1120A0	NTC TEMPERATUR E PROBE SEAL	1	PZ	GN1120A1	NTC TEMPERATUR E PROBE SEAL	1	PZ																								
Code	Description	Qty	UOM																																			
GN1120A0	NTC TEMPERATUR E PROBE SEAL	1	PZ																																			
GN1120A1	NTC TEMPERATUR E PROBE SEAL	1	PZ																																			





COMPONENT			SPARE PART																															
Code	Description	Image	Code	Description	Components list																													
VM1465A	CT BT TEMPERATURE PROBE COVER		KTR1095A	NTC 150 L=1050 TEMPERATURE PROBE KIT	<table border="1"> <thead> <tr> <th>Code</th> <th>Description</th> <th>Qty</th> <th>UOM</th> </tr> </thead> <tbody> <tr> <td>GN1285A0</td> <td>NTC TEMPERATUR E PROBE SEALING</td> <td>1</td> <td>PZ</td> </tr> <tr> <td>SL1045A0</td> <td>S57 BLACK SILICONE - 80ML CARTRIDGE</td> <td>1</td> <td>PZ</td> </tr> <tr> <td>TR1095A0</td> <td>TEMPERATUR E PROBE NTC 150 L=1050</td> <td>1</td> <td>PZ</td> </tr> <tr> <td>VI1220A1</td> <td>4,2X12 TCB SELF-TAPPIN G SCREW</td> <td>2</td> <td>PZ</td> </tr> <tr> <td>VM1465A0</td> <td>CHEFTOP TEMPERATUR E PROBE COVER</td> <td>1</td> <td>PZ</td> </tr> <tr> <td>VM1465A1</td> <td>CT BT TEMPERATUR E PROBE COVER</td> <td>1</td> <td>PZ</td> </tr> </tbody> </table>	Code	Description	Qty	UOM	GN1285A0	NTC TEMPERATUR E PROBE SEALING	1	PZ	SL1045A0	S57 BLACK SILICONE - 80ML CARTRIDGE	1	PZ	TR1095A0	TEMPERATUR E PROBE NTC 150 L=1050	1	PZ	VI1220A1	4,2X12 TCB SELF-TAPPIN G SCREW	2	PZ	VM1465A0	CHEFTOP TEMPERATUR E PROBE COVER	1	PZ	VM1465A1	CT BT TEMPERATUR E PROBE COVER	1	PZ	
			Code	Description	Qty	UOM																												
			GN1285A0	NTC TEMPERATUR E PROBE SEALING	1	PZ																												
SL1045A0	S57 BLACK SILICONE - 80ML CARTRIDGE	1	PZ																															
TR1095A0	TEMPERATUR E PROBE NTC 150 L=1050	1	PZ																															
VI1220A1	4,2X12 TCB SELF-TAPPIN G SCREW	2	PZ																															
VM1465A0	CHEFTOP TEMPERATUR E PROBE COVER	1	PZ																															
VM1465A1	CT BT TEMPERATUR E PROBE COVER	1	PZ																															
KTR1003B	US MM L2000 CHAMBER TEMP. PROBE KIT	<table border="1"> <thead> <tr> <th>Code</th> <th>Description</th> <th>Qty</th> <th>UOM</th> </tr> </thead> <tbody> <tr> <td>GN1285A0</td> <td>NTC TEMPERATUR E PROBE SEALING</td> <td>1</td> <td>PZ</td> </tr> <tr> <td>SL1045A0</td> <td>S57 BLACK SILICONE - 80ML CARTRIDGE</td> <td>1</td> <td>PZ</td> </tr> <tr> <td>TR1003B0</td> <td></td> <td>1</td> <td>PZ</td> </tr> <tr> <td>VI1220A1</td> <td>4,2X12 TCB SELF-TAPPIN G SCREW</td> <td>2</td> <td>PZ</td> </tr> <tr> <td>VM1464A1</td> <td>CT BT TEMPERATUR E PROBE COVER</td> <td>1</td> <td>PZ</td> </tr> <tr> <td>VM1465A0</td> <td>CHEFTOP TEMPERATUR E PROBE COVER</td> <td>1</td> <td>PZ</td> </tr> <tr> <td>VM1465A1</td> <td>CT BT TEMPERATUR E PROBE COVER</td> <td>1</td> <td>PZ</td> </tr> </tbody> </table>	Code	Description	Qty	UOM	GN1285A0	NTC TEMPERATUR E PROBE SEALING	1	PZ	SL1045A0	S57 BLACK SILICONE - 80ML CARTRIDGE	1	PZ	TR1003B0		1	PZ	VI1220A1	4,2X12 TCB SELF-TAPPIN G SCREW	2	PZ	VM1464A1	CT BT TEMPERATUR E PROBE COVER	1	PZ	VM1465A0	CHEFTOP TEMPERATUR E PROBE COVER	1	PZ	VM1465A1	CT BT TEMPERATUR E PROBE COVER	1	PZ
Code	Description	Qty	UOM																															
GN1285A0	NTC TEMPERATUR E PROBE SEALING	1	PZ																															
SL1045A0	S57 BLACK SILICONE - 80ML CARTRIDGE	1	PZ																															
TR1003B0		1	PZ																															
VI1220A1	4,2X12 TCB SELF-TAPPIN G SCREW	2	PZ																															
VM1464A1	CT BT TEMPERATUR E PROBE COVER	1	PZ																															
VM1465A0	CHEFTOP TEMPERATUR E PROBE COVER	1	PZ																															
VM1465A1	CT BT TEMPERATUR E PROBE COVER	1	PZ																															
KTR1003A	5-5E S.CHEFTOP US TEMPERATURE PROBE KIT	<table border="1"> <thead> <tr> <th>Code</th> <th>Description</th> <th>Qty</th> <th>UOM</th> </tr> </thead> <tbody> <tr> <td>GN1285A0</td> <td>NTC TEMPERATUR E PROBE SEALING</td> <td>1</td> <td>PZ</td> </tr> </tbody> </table>	Code	Description	Qty	UOM	GN1285A0	NTC TEMPERATUR E PROBE SEALING	1	PZ																								
Code	Description	Qty	UOM																															
GN1285A0	NTC TEMPERATUR E PROBE SEALING	1	PZ																															



COMPONENT			SPARE PART																											
Code	Description	Image	Code	Description	Components list																									
VM1465A	CT BT TEMPERATURE PROBE COVER		KTR1003A	5-5E S.CHEFTOP US TEMPERATURE PROBE KIT	<table border="1"> <thead> <tr> <th>Code</th> <th>Description</th> <th>Qty</th> <th>UOM</th> </tr> </thead> <tbody> <tr> <td>SL1045A0</td> <td>S57 BLACK SILICONE - 80ML CARTRIDGE</td> <td>1</td> <td>PZ</td> </tr> <tr> <td>TR1003A0</td> <td>PT100 L2000 TEMPERATUR E PROBE-US VERSION</td> <td>1</td> <td>PZ</td> </tr> <tr> <td>VI1220A1</td> <td>4,2X12 TCB SELF-TAPPIN G SCREW</td> <td>2</td> <td>PZ</td> </tr> <tr> <td>VM1465A0</td> <td>CHEFTOP TEMPERATUR E PROBE COVER</td> <td>1</td> <td>PZ</td> </tr> <tr> <td>VM1465A1</td> <td>CT BT TEMPERATUR E PROBE COVER</td> <td>1</td> <td>PZ</td> </tr> </tbody> </table>	Code	Description	Qty	UOM	SL1045A0	S57 BLACK SILICONE - 80ML CARTRIDGE	1	PZ	TR1003A0	PT100 L2000 TEMPERATUR E PROBE-US VERSION	1	PZ	VI1220A1	4,2X12 TCB SELF-TAPPIN G SCREW	2	PZ	VM1465A0	CHEFTOP TEMPERATUR E PROBE COVER	1	PZ	VM1465A1	CT BT TEMPERATUR E PROBE COVER	1	PZ	
			Code	Description	Qty	UOM																								
SL1045A0	S57 BLACK SILICONE - 80ML CARTRIDGE	1	PZ																											
TR1003A0	PT100 L2000 TEMPERATUR E PROBE-US VERSION	1	PZ																											
VI1220A1	4,2X12 TCB SELF-TAPPIN G SCREW	2	PZ																											
VM1465A0	CHEFTOP TEMPERATUR E PROBE COVER	1	PZ																											
VM1465A1	CT BT TEMPERATUR E PROBE COVER	1	PZ																											
KTR1002A	PT100 L1000 UL TEMPERATURE PROBE KIT	<table border="1"> <thead> <tr> <th>Code</th> <th>Description</th> <th>Qty</th> <th>UOM</th> </tr> </thead> <tbody> <tr> <td>GN1285A0</td> <td>NTC TEMPERATUR E PROBE SEALING</td> <td>2</td> <td>PZ</td> </tr> <tr> <td>SL1045A0</td> <td>S57 BLACK SILICONE - 80ML CARTRIDGE</td> <td>1</td> <td>PZ</td> </tr> <tr> <td>TR1002A1</td> <td></td> <td>1</td> <td>PZ</td> </tr> <tr> <td>VI1220A1</td> <td>4,2X12 TCB SELF-TAPPIN G SCREW</td> <td>2</td> <td>PZ</td> </tr> <tr> <td>VM1465A0</td> <td>CHEFTOP TEMPERATUR E PROBE COVER</td> <td>1</td> <td>PZ</td> </tr> <tr> <td>VM1465A1</td> <td>CT BT TEMPERATUR E PROBE COVER</td> <td>1</td> <td>PZ</td> </tr> </tbody> </table>	Code	Description	Qty	UOM	GN1285A0	NTC TEMPERATUR E PROBE SEALING	2	PZ	SL1045A0	S57 BLACK SILICONE - 80ML CARTRIDGE	1	PZ	TR1002A1		1	PZ	VI1220A1	4,2X12 TCB SELF-TAPPIN G SCREW	2	PZ	VM1465A0	CHEFTOP TEMPERATUR E PROBE COVER	1	PZ	VM1465A1	CT BT TEMPERATUR E PROBE COVER	1	PZ
Code	Description	Qty	UOM																											
GN1285A0	NTC TEMPERATUR E PROBE SEALING	2	PZ																											
SL1045A0	S57 BLACK SILICONE - 80ML CARTRIDGE	1	PZ																											
TR1002A1		1	PZ																											
VI1220A1	4,2X12 TCB SELF-TAPPIN G SCREW	2	PZ																											
VM1465A0	CHEFTOP TEMPERATUR E PROBE COVER	1	PZ																											
VM1465A1	CT BT TEMPERATUR E PROBE COVER	1	PZ																											
GN1343C	XBC805E DOOR GASKET - GN1006A		KGN1664A	XB-XV800 DOOR GASKET KIT	<table border="1"> <thead> <tr> <th>Code</th> <th>Description</th> <th>Qty</th> <th>UOM</th> </tr> </thead> <tbody> <tr> <td>GN1626A0</td> <td>DOUBLE LIP-TYPE FRONT GASKE</td> <td>3.150</td> <td>M</td> </tr> <tr> <td>SL1025A0</td> <td>CLEAR SILICON DOW CORNING 734</td> <td>0.012</td> <td>PZ</td> </tr> <tr> <td>VM1224A0</td> <td>65MY 220MM 2 COLOURS SHRINK TUBE</td> <td>0.450</td> <td>M</td> </tr> <tr> <td>VM2277A0</td> <td>DOOR SEAL KIT INTERNAL CONNECTION</td> <td>1</td> <td>PZ</td> </tr> </tbody> </table>	Code	Description	Qty	UOM	GN1626A0	DOUBLE LIP-TYPE FRONT GASKE	3.150	M	SL1025A0	CLEAR SILICON DOW CORNING 734	0.012	PZ	VM1224A0	65MY 220MM 2 COLOURS SHRINK TUBE	0.450	M	VM2277A0	DOOR SEAL KIT INTERNAL CONNECTION	1	PZ					
Code	Description	Qty	UOM																											
GN1626A0	DOUBLE LIP-TYPE FRONT GASKE	3.150	M																											
SL1025A0	CLEAR SILICON DOW CORNING 734	0.012	PZ																											
VM1224A0	65MY 220MM 2 COLOURS SHRINK TUBE	0.450	M																											
VM2277A0	DOOR SEAL KIT INTERNAL CONNECTION	1	PZ																											



COMPONENT			SPARE PART														
Code	Description	Image	Code	Description	Components list												
VM1820A	LATERAL SUPPORTS M6 FIXING BOLT		KVM1820A	THUMB SCREW 10PCS KIT	<table border="1"> <thead> <tr> <th>Code</th> <th>Description</th> <th>Qty</th> <th>UOM</th> </tr> </thead> <tbody> <tr> <td>VM1224A0</td> <td>65MY 220MM 2 COLOURS SHRINK TUBE</td> <td>0.200</td> <td>M</td> </tr> <tr> <td>VM1820A0</td> <td>LATERAL SUPPORTS M6 FIXING BOLT</td> <td>10</td> <td>PZ</td> </tr> </tbody> </table>	Code	Description	Qty	UOM	VM1224A0	65MY 220MM 2 COLOURS SHRINK TUBE	0.200	M	VM1820A0	LATERAL SUPPORTS M6 FIXING BOLT	10	PZ
Code	Description	Qty	UOM														
VM1224A0	65MY 220MM 2 COLOURS SHRINK TUBE	0.200	M														
VM1820A0	LATERAL SUPPORTS M6 FIXING BOLT	10	PZ														