





| Assembly code  | Assembly description | Assembly image  |
|----------------|----------------------|---|
| ASM2749B/0.D01 | Cooking chamber      |    |
| ASM2750A/0.D01 | External cover       |    |
| ASM4079A/0.D02 | Door                 |   |
| ASM4098A/0.D00 | Electrical system    |  |



**ASM2749B/0.D01 - Cooking chamber - FRONT**

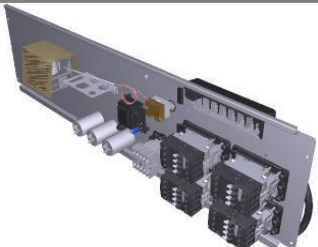
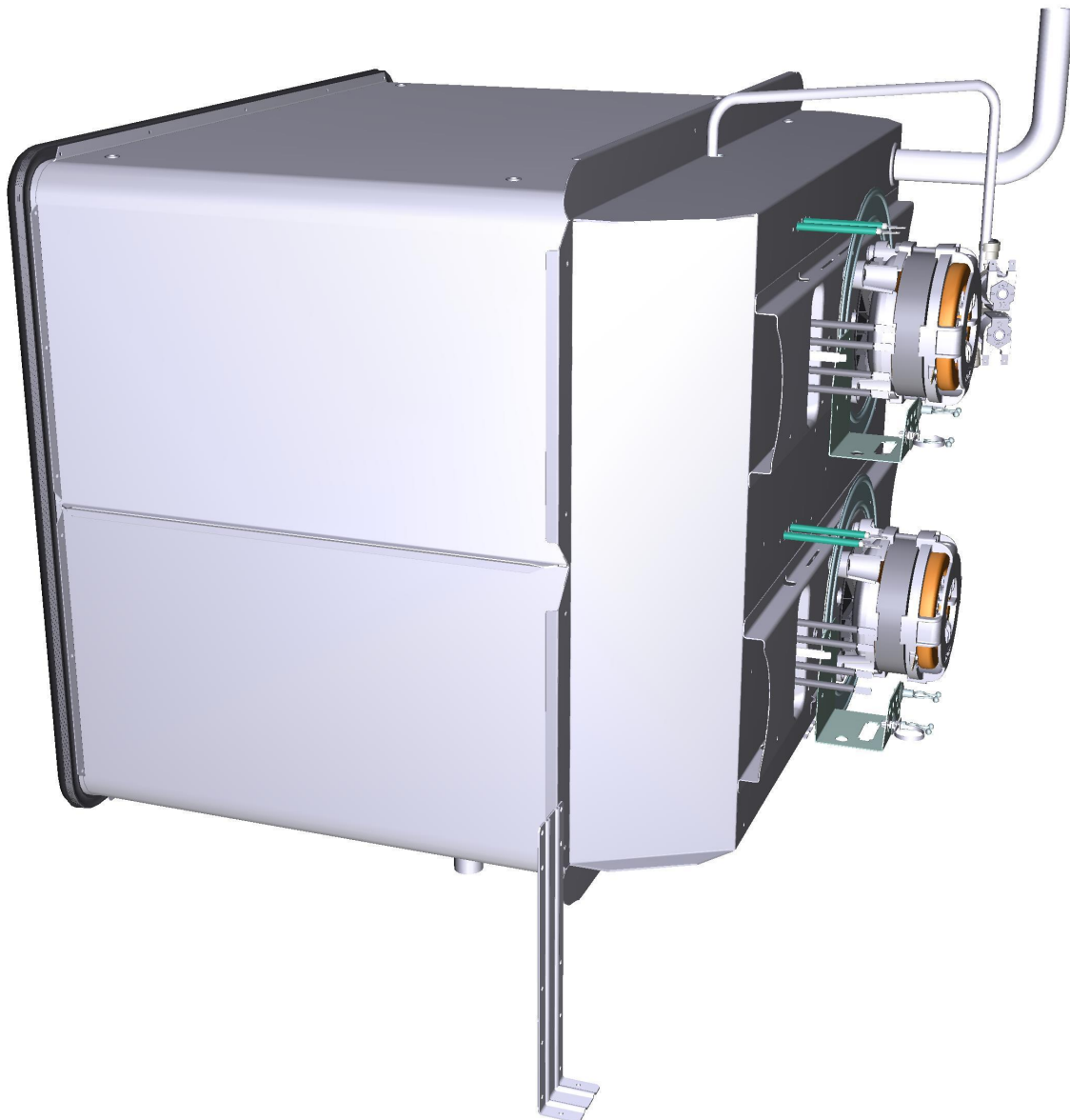



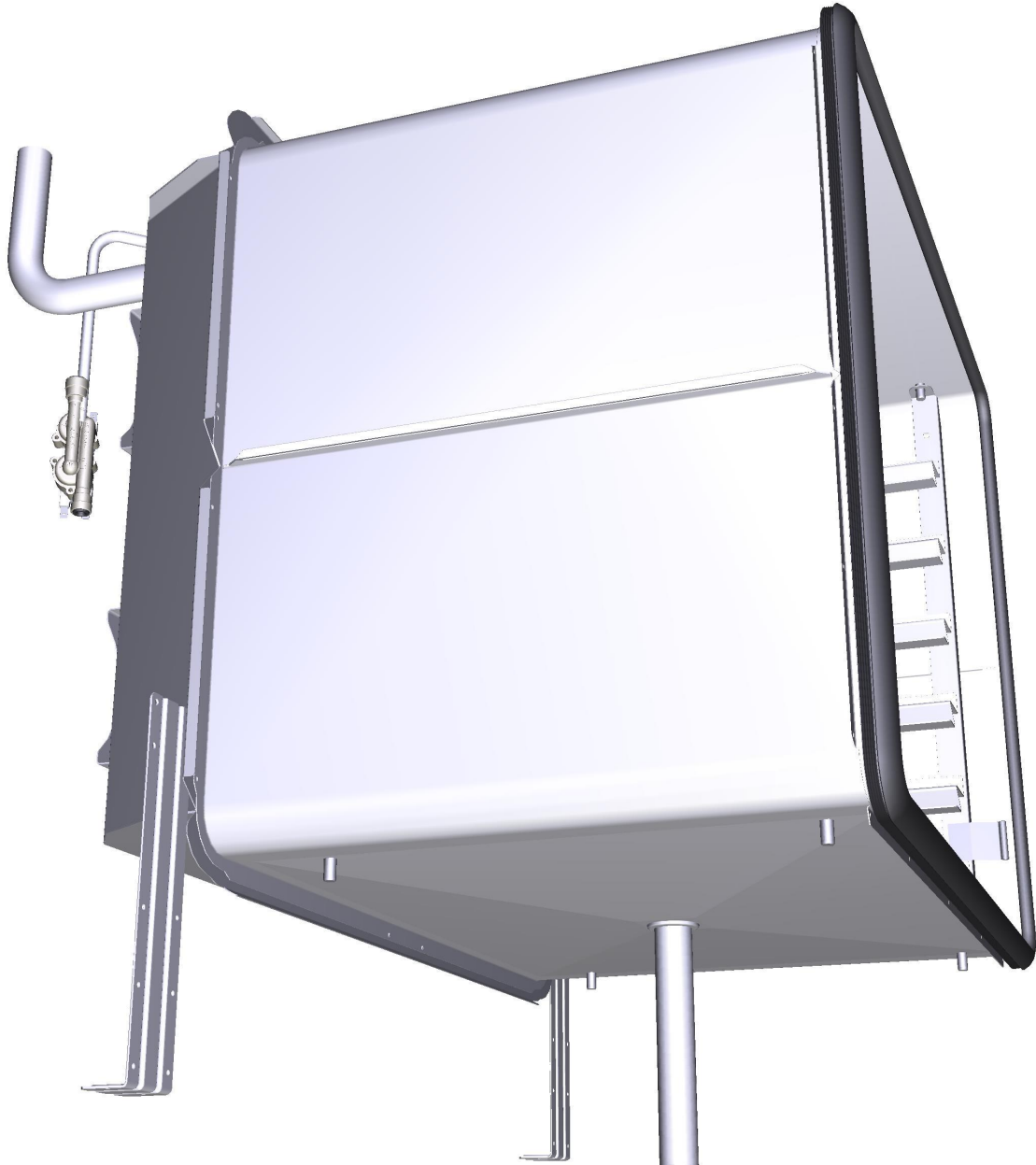

**ASM2749B/0.D01 - Cooking chamber - REAR**



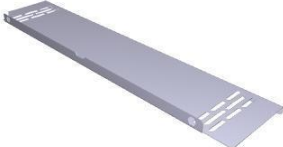
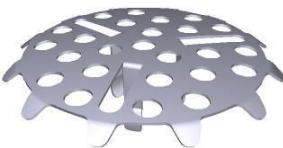

| COMPONENT |   |   | SPARE PART |   |   |      |             |     |     |          |                                    |       |    |
|-----------|---|---|------------|---|---|------|-------------|-----|-----|----------|------------------------------------|-------|----|
| Code      | Description                                 | Image   | Code       | Description                                 | Kit components  |      |             |     |     |          |                                    |       |    |
| 0G1474A   | 0G1474A1                                    |    | 0G1474A1   | 0G1474A1                                    |   |      |             |     |     |          |                                    |       |    |
| 0G1476A   | BL CL FAN GUARD<br>SPACER                   |    | 0G1476A0   | BL CL FAN GUARD<br>SPACER                   |   |      |             |     |     |          |                                    |       |    |
| 0H2551A   | XBC/XVC ST.STEEL<br>DRAIN COVER             |  | K0H2551A   | DRAIN COVER KIT                             | <table border="1"> <thead> <tr> <th>Code</th> <th>Description</th> <th>Qty</th> <th>UOM</th> </tr> </thead> <tbody> <tr> <td>0H2551A0</td> <td>XBC/XVC<br/>ST.STEEL<br/>DRAIN COVER</td> <td>1.000</td> <td>PC</td> </tr> </tbody> </table> | Code | Description | Qty | UOM | 0H2551A0 | XBC/XVC<br>ST.STEEL<br>DRAIN COVER | 1.000 | PC |
| Code      | Description                                 | Qty   | UOM        |   |   |      |             |     |     |          |                                    |       |    |
| 0H2551A0  | XBC/XVC<br>ST.STEEL<br>DRAIN COVER          | 1.000   | PC         |   |   |      |             |     |     |          |                                    |       |    |
| 0H4820A   | BULB HOLDING<br>BRACKET                     |  | 0H4820A1   | BULB HOLDING<br>BRACKET                     |   |      |             |     |     |          |                                    |       |    |
| 0H6334A   | BL CL COOKING<br>CHAMBER HOLDING<br>BRACKET |  | 0H6334A0   | BL CL COOKING<br>CHAMBER HOLDING<br>BRACKET |   |      |             |     |     |          |                                    |       |    |



| COMPONENT |                                     |   | SPARE PART |                                  |   |      |             |     |     |          |                                    |       |    |          |                            |       |    |          |                                     |       |    |          |                               |       |    |
|-----------|-------------------------------------|---|------------|----------------------------------|---|------|-------------|-----|-----|----------|------------------------------------|-------|----|----------|----------------------------|-------|----|----------|-------------------------------------|-------|----|----------|-------------------------------|-------|----|
| Code      | Description                         | Image   | Code       | Description                      | Kit components  |      |             |     |     |          |                                    |       |    |          |                            |       |    |          |                                     |       |    |          |                               |       |    |
| 0H3586A   | ZINCED MOTOR GUARD PLATE XBC-XVC    |    | 0H3586A0   | ZINCED MOTOR GUARD PLATE XBC-XVC |   |      |             |     |     |          |                                    |       |    |          |                            |       |    |          |                                     |       |    |          |                               |       |    |
| 0H4305A   | ST. STEEL MOTOR SHAFT SEALING DIS   |   | K0H4305A   | SEALING DISC FOR MOTOR SHAFT KIT | <table border="1"> <thead> <tr> <th>Code</th> <th>Description</th> <th>Qty</th> <th>UOM</th> </tr> </thead> <tbody> <tr> <td>0H4305A1</td> <td>ST. STEEL MOTOR SHAFT SEALING DISC</td> <td>1.000</td> <td>PC</td> </tr> <tr> <td>GN1140A3</td> <td>MOLDED MOTOR HOLDER GASKET</td> <td>1.000</td> <td>PC</td> </tr> <tr> <td>SL1045A0</td> <td>S57 BLACK SILICONE - 80ml CARTRIDGE</td> <td>1.000</td> <td>PC</td> </tr> <tr> <td>VI1220A1</td> <td>4,2x12 TCB SELF-TAPPING SCREW</td> <td>3.000</td> <td>PC</td> </tr> </tbody> </table> | Code | Description | Qty | UOM | 0H4305A1 | ST. STEEL MOTOR SHAFT SEALING DISC | 1.000 | PC | GN1140A3 | MOLDED MOTOR HOLDER GASKET | 1.000 | PC | SL1045A0 | S57 BLACK SILICONE - 80ml CARTRIDGE | 1.000 | PC | VI1220A1 | 4,2x12 TCB SELF-TAPPING SCREW | 3.000 | PC |
| Code      | Description                         | Qty   | UOM        |                                  |   |      |             |     |     |          |                                    |       |    |          |                            |       |    |          |                                     |       |    |          |                               |       |    |
| 0H4305A1  | ST. STEEL MOTOR SHAFT SEALING DISC  | 1.000   | PC         |                                  |   |      |             |     |     |          |                                    |       |    |          |                            |       |    |          |                                     |       |    |          |                               |       |    |
| GN1140A3  | MOLDED MOTOR HOLDER GASKET          | 1.000   | PC         |                                  |   |      |             |     |     |          |                                    |       |    |          |                            |       |    |          |                                     |       |    |          |                               |       |    |
| SL1045A0  | S57 BLACK SILICONE - 80ml CARTRIDGE | 1.000   | PC         |                                  |   |      |             |     |     |          |                                    |       |    |          |                            |       |    |          |                                     |       |    |          |                               |       |    |
| VI1220A1  | 4,2x12 TCB SELF-TAPPING SCREW       | 3.000   | PC         |                                  |   |      |             |     |     |          |                                    |       |    |          |                            |       |    |          |                                     |       |    |          |                               |       |    |
| 0H4851A   | BT CT WIRING SUPPORT BRACKET        |  | 0H4851A1   | BT CT WIRING SUPPORT BRACKET     |   |      |             |     |     |          |                                    |       |    |          |                            |       |    |          |                                     |       |    |          |                               |       |    |
| GN1140A   | MOLDED MOTOR HOLDER GASKET          |  | KGN1140A   | 5 PCS. MOTOR HOLDER GASKET KI    | <table border="1"> <thead> <tr> <th>Code</th> <th>Description</th> <th>Qty</th> <th>UOM</th> </tr> </thead> <tbody> <tr> <td>GN1140A3</td> <td>MOLDED MOTOR HOLDER GASKET</td> <td>5.000</td> <td>PC</td> </tr> </tbody> </table>   | Code | Description | Qty | UOM | GN1140A3 | MOLDED MOTOR HOLDER GASKET         | 5.000 | PC |          |                            |       |    |          |                                     |       |    |          |                               |       |    |
| Code      | Description                         | Qty   | UOM        |                                  |   |      |             |     |     |          |                                    |       |    |          |                            |       |    |          |                                     |       |    |          |                               |       |    |
| GN1140A3  | MOLDED MOTOR HOLDER GASKET          | 5.000   | PC         |                                  |   |      |             |     |     |          |                                    |       |    |          |                            |       |    |          |                                     |       |    |          |                               |       |    |

| COMPONENT |   |  | SPARE PART |   |   |      |             |                        |       |          |   |   |       |          |                                     |                                     |       |          |  |                    |       |          |   |                               |       |          |                                   |                        |       |          |                           |  |       |    |          |                            |       |    |          |                       |       |    |
|-----------|---|--|------------|---|---|------|-------------|------------------------|-------|----------|---|---|-------|----------|-------------------------------------|-------------------------------------|-------|----------|--|--------------------|-------|----------|---|-------------------------------|-------|----------|-----------------------------------|------------------------|-------|----------|---------------------------|--|-------|----|----------|----------------------------|-------|----|----------|-----------------------|-------|----|
| Code      | Description                                     | Image  | Code       | Description                                 | Kit components  |      |             |                        |       |          |   |   |       |          |                                     |                                     |       |          |  |                    |       |          |   |                               |       |          |                                   |                        |       |          |                           |  |       |    |          |                            |       |    |          |                       |       |    |
| MT1012A   | 330W 230V MOTOR                                 |   | KVN1130A   | LUX<br>≤08.2017/L.MISS/S.5/<br>5E MOTOR KIT | <table border="1"> <thead> <tr> <th>Code</th> <th>Description</th> <th>Qty</th> <th>UOM</th> </tr> </thead> <tbody> <tr> <td>0H4305A1</td> <td>ST. STEEL<br/>MOTOR<br/>SHAFT<br/>SEALING DISC</td> <td>1.000</td> <td>PC</td> </tr> <tr> <td>GN1140A3</td> <td>MOLDED<br/>MOTOR<br/>HOLDER<br/>GASKET</td> <td>1.000</td> <td>PC</td> </tr> <tr> <td>VI1034A0</td> <td>STAINLESS<br/>STEEL<br/>WASHER<br/>8.4x16x1</td> <td>1.000</td> <td>PC</td> </tr> <tr> <td>VI1256A0</td> <td>M8 DIN 980M<br/>ST. STEEL<br/>SELF<br/>LOCKING NUT</td> <td>1.000</td> <td>PC</td> </tr> <tr> <td>VM2196A0</td> <td>MOTOR NUT<br/>FASTENING<br/>BUSHING</td> <td>1.000</td> <td>PC</td> </tr> <tr> <td>VN1130A1</td> <td>330W 230V<br/>50/60HZ MOTO</td> <td>1.000</td> <td>PC</td> </tr> </tbody> </table> | Code | Description | Qty                    | UOM   | 0H4305A1 | ST. STEEL<br>MOTOR<br>SHAFT<br>SEALING DISC | 1.000                                       | PC    | GN1140A3 | MOLDED<br>MOTOR<br>HOLDER<br>GASKET | 1.000                               | PC    | VI1034A0 | STAINLESS<br>STEEL<br>WASHER<br>8.4x16x1 | 1.000              | PC    | VI1256A0 | M8 DIN 980M<br>ST. STEEL<br>SELF<br>LOCKING NUT | 1.000                         | PC    | VM2196A0 | MOTOR NUT<br>FASTENING<br>BUSHING | 1.000                  | PC    | VN1130A1 | 330W 230V<br>50/60HZ MOTO | 1.000                                    | PC    |    |          |                            |       |    |          |                       |       |    |
|           |   |  | Code       | Description                                 | Qty   | UOM  |             |                        |       |          |   |   |       |          |                                     |                                     |       |          |  |                    |       |          |   |                               |       |          |                                   |                        |       |          |                           |  |       |    |          |                            |       |    |          |                       |       |    |
| 0H4305A1  | ST. STEEL<br>MOTOR<br>SHAFT<br>SEALING DISC     | 1.000  | PC         |   |   |      |             |                        |       |          |   |   |       |          |                                     |                                     |       |          |  |                    |       |          |   |                               |       |          |                                   |                        |       |          |                           |  |       |    |          |                            |       |    |          |                       |       |    |
| GN1140A3  | MOLDED<br>MOTOR<br>HOLDER<br>GASKET             | 1.000  | PC         |   |   |      |             |                        |       |          |   |   |       |          |                                     |                                     |       |          |  |                    |       |          |   |                               |       |          |                                   |                        |       |          |                           |  |       |    |          |                            |       |    |          |                       |       |    |
| VI1034A0  | STAINLESS<br>STEEL<br>WASHER<br>8.4x16x1        | 1.000  | PC         |   |   |      |             |                        |       |          |   |   |       |          |                                     |                                     |       |          |  |                    |       |          |   |                               |       |          |                                   |                        |       |          |                           |  |       |    |          |                            |       |    |          |                       |       |    |
| VI1256A0  | M8 DIN 980M<br>ST. STEEL<br>SELF<br>LOCKING NUT | 1.000  | PC         |   |   |      |             |                        |       |          |   |   |       |          |                                     |                                     |       |          |  |                    |       |          |   |                               |       |          |                                   |                        |       |          |                           |  |       |    |          |                            |       |    |          |                       |       |    |
| VM2196A0  | MOTOR NUT<br>FASTENING<br>BUSHING               | 1.000  | PC         |   |   |      |             |                        |       |          |   |   |       |          |                                     |                                     |       |          |  |                    |       |          |   |                               |       |          |                                   |                        |       |          |                           |  |       |    |          |                            |       |    |          |                       |       |    |
| VN1130A1  | 330W 230V<br>50/60HZ MOTO                       | 1.000  | PC         |   |   |      |             |                        |       |          |   |   |       |          |                                     |                                     |       |          |  |                    |       |          |   |                               |       |          |                                   |                        |       |          |                           |  |       |    |          |                            |       |    |          |                       |       |    |
| KMT1012A  | LUX >08.2017 /<br>MIND.MAPS 330W<br>MOTOR KIT   | <table border="1"> <thead> <tr> <th>Code</th> <th>Description</th> <th>Qty</th> <th>UOM</th> </tr> </thead> <tbody> <tr> <td>0H2842A0</td> <td>MT1012<br/>CENTERING JI</td> <td>1.000</td> <td>PC</td> </tr> <tr> <td>0H4305A1</td> <td>ST. STEEL<br/>MOTOR<br/>SHAFT<br/>SEALING DISC</td> <td>1.000</td> <td>PC</td> </tr> <tr> <td>GN1140A3</td> <td>MOLDED<br/>MOTOR<br/>HOLDER<br/>GASKET</td> <td>1.000</td> <td>PC</td> </tr> <tr> <td>MT1012A0</td> <td>330W 230V<br/>MOTOR</td> <td>1.000</td> <td>PC</td> </tr> <tr> <td>VE1550A0</td> <td>5X3 MM<br/>NEODYMIUM<br/>MAGNET</td> <td>1.000</td> <td>PC</td> </tr> <tr> <td>VI1077A1</td> <td>SCREW M6x12<br/>TE INOX</td> <td>1.000</td> <td>PC</td> </tr> <tr> <td>VI1521A0</td> <td>STAINLESS<br/>STEEL<br/>WASHER D=6<br/>6592</td> <td>1.000</td> <td>PC</td> </tr> <tr> <td>VI1966A0</td> <td>M4X14<br/>FLATHEAD<br/>SCREW</td> <td>1.000</td> <td>PC</td> </tr> <tr> <td>VM1635A0</td> <td>MAGNET<br/>HOLDING DIS</td> <td>1.000</td> <td>PC</td> </tr> </tbody> </table> | Code       | Description                                 | Qty   | UOM  | 0H2842A0    | MT1012<br>CENTERING JI | 1.000 | PC       | 0H4305A1                                    | ST. STEEL<br>MOTOR<br>SHAFT<br>SEALING DISC | 1.000 | PC       | GN1140A3                            | MOLDED<br>MOTOR<br>HOLDER<br>GASKET | 1.000 | PC       | MT1012A0                                 | 330W 230V<br>MOTOR | 1.000 | PC       | VE1550A0  | 5X3 MM<br>NEODYMIUM<br>MAGNET | 1.000 | PC       | VI1077A1                          | SCREW M6x12<br>TE INOX | 1.000 | PC       | VI1521A0                  | STAINLESS<br>STEEL<br>WASHER D=6<br>6592 | 1.000 | PC | VI1966A0 | M4X14<br>FLATHEAD<br>SCREW | 1.000 | PC | VM1635A0 | MAGNET<br>HOLDING DIS | 1.000 | PC |
| Code      | Description                                     | Qty  | UOM        |   |   |      |             |                        |       |          |   |   |       |          |                                     |                                     |       |          |  |                    |       |          |   |                               |       |          |                                   |                        |       |          |                           |  |       |    |          |                            |       |    |          |                       |       |    |
| 0H2842A0  | MT1012<br>CENTERING JI                          | 1.000  | PC         |   |   |      |             |                        |       |          |   |   |       |          |                                     |                                     |       |          |  |                    |       |          |   |                               |       |          |                                   |                        |       |          |                           |  |       |    |          |                            |       |    |          |                       |       |    |
| 0H4305A1  | ST. STEEL<br>MOTOR<br>SHAFT<br>SEALING DISC     | 1.000  | PC         |   |   |      |             |                        |       |          |   |   |       |          |                                     |                                     |       |          |  |                    |       |          |   |                               |       |          |                                   |                        |       |          |                           |  |       |    |          |                            |       |    |          |                       |       |    |
| GN1140A3  | MOLDED<br>MOTOR<br>HOLDER<br>GASKET             | 1.000  | PC         |   |   |      |             |                        |       |          |   |   |       |          |                                     |                                     |       |          |  |                    |       |          |   |                               |       |          |                                   |                        |       |          |                           |  |       |    |          |                            |       |    |          |                       |       |    |
| MT1012A0  | 330W 230V<br>MOTOR                              | 1.000  | PC         |   |   |      |             |                        |       |          |   |   |       |          |                                     |                                     |       |          |  |                    |       |          |   |                               |       |          |                                   |                        |       |          |                           |  |       |    |          |                            |       |    |          |                       |       |    |
| VE1550A0  | 5X3 MM<br>NEODYMIUM<br>MAGNET                   | 1.000  | PC         |   |   |      |             |                        |       |          |   |   |       |          |                                     |                                     |       |          |  |                    |       |          |   |                               |       |          |                                   |                        |       |          |                           |  |       |    |          |                            |       |    |          |                       |       |    |
| VI1077A1  | SCREW M6x12<br>TE INOX                          | 1.000  | PC         |   |   |      |             |                        |       |          |   |   |       |          |                                     |                                     |       |          |  |                    |       |          |   |                               |       |          |                                   |                        |       |          |                           |  |       |    |          |                            |       |    |          |                       |       |    |
| VI1521A0  | STAINLESS<br>STEEL<br>WASHER D=6<br>6592        | 1.000  | PC         |   |   |      |             |                        |       |          |   |   |       |          |                                     |                                     |       |          |  |                    |       |          |   |                               |       |          |                                   |                        |       |          |                           |  |       |    |          |                            |       |    |          |                       |       |    |
| VI1966A0  | M4X14<br>FLATHEAD<br>SCREW                      | 1.000  | PC         |   |   |      |             |                        |       |          |   |   |       |          |                                     |                                     |       |          |  |                    |       |          |   |                               |       |          |                                   |                        |       |          |                           |  |       |    |          |                            |       |    |          |                       |       |    |
| VM1635A0  | MAGNET<br>HOLDING DIS                           | 1.000  | PC         |   |   |      |             |                        |       |          |   |   |       |          |                                     |                                     |       |          |  |                    |       |          |   |                               |       |          |                                   |                        |       |          |                           |  |       |    |          |                            |       |    |          |                       |       |    |







| COMPONENT |   |  | SPARE PART |  |   |      |             |   |       |          |   |                                   |       |          |  |                                    |       |          |  |       |    |          |                                      |       |    |
|-----------|---|--|------------|--|---|------|-------------|---|-------|----------|---|-----------------------------------|-------|----------|--|------------------------------------|-------|----------|--|-------|----|----------|--------------------------------------|-------|----|
| Code      | Description                                     | Image  | Code       | Description                                  | Kit components  |      |             |   |       |          |   |                                   |       |          |  |                                    |       |          |  |       |    |          |                                      |       |    |
| VN1181A   | M6 NUT 39 BLADES<br>H81 D196 FAN                |   | KVN1181A   | D196 H81 39<br>BLADES<br>FAN+SCREW M6 KIT    | <table border="1"> <thead> <tr> <th>Code</th> <th>Description</th> <th>Qty</th> <th>UOM</th> </tr> </thead> <tbody> <tr> <td>VI1077A1</td> <td>SCREW M6x12<br/>TE INOX</td> <td>1.000</td> <td>PC</td> </tr> <tr> <td>VI1521A0</td> <td>STAINLESS<br/>STEEL<br/>WASHER D=6<br/>6592</td> <td>1.000</td> <td>PC</td> </tr> <tr> <td>VN1181A0</td> <td>M6 NUT 39<br/>BLADES H81<br/>D196 FAN</td> <td>1.000</td> <td>PC</td> </tr> </tbody> </table>  | Code | Description | Qty   | UOM   | VI1077A1 | SCREW M6x12<br>TE INOX                    | 1.000                             | PC    | VI1521A0 | STAINLESS<br>STEEL<br>WASHER D=6<br>6592 | 1.000                              | PC    | VN1181A0 | M6 NUT 39<br>BLADES H81<br>D196 FAN          | 1.000 | PC |          |                                      |       |    |
|           |   |  | Code       | Description                                  | Qty   | UOM  |             |   |       |          |   |                                   |       |          |  |                                    |       |          |  |       |    |          |                                      |       |    |
| VI1077A1  | SCREW M6x12<br>TE INOX                          | 1.000  | PC         |  |   |      |             |   |       |          |   |                                   |       |          |  |                                    |       |          |  |       |    |          |                                      |       |    |
| VI1521A0  | STAINLESS<br>STEEL<br>WASHER D=6<br>6592        | 1.000  | PC         |  |   |      |             |   |       |          |   |                                   |       |          |  |                                    |       |          |  |       |    |          |                                      |       |    |
| VN1181A0  | M6 NUT 39<br>BLADES H81<br>D196 FAN             | 1.000  | PC         |  |   |      |             |   |       |          |   |                                   |       |          |  |                                    |       |          |  |       |    |          |                                      |       |    |
| KVN1030A  | LUX<br>≤08.2017S.5/S.5E<br>D196 FAN KIT         | <table border="1"> <thead> <tr> <th>Code</th> <th>Description</th> <th>Qty</th> <th>UOM</th> </tr> </thead> <tbody> <tr> <td>VI1256A0</td> <td>M8 DIN 980M<br/>ST. STEEL<br/>SELF<br/>LOCKING NUT</td> <td>1.000</td> <td>PC</td> </tr> <tr> <td>VM2196A0</td> <td>MOTOR NUT<br/>FASTENING<br/>BUSHING</td> <td>1.000</td> <td>PC</td> </tr> <tr> <td>VN1030A5</td> <td>Ø196 H81 38<br/>BLADES<br/>MOTOR FAN</td> <td>1.000</td> <td>PC</td> </tr> </tbody> </table> | Code       | Description                                  | Qty   | UOM  | VI1256A0    | M8 DIN 980M<br>ST. STEEL<br>SELF<br>LOCKING NUT | 1.000 | PC       | VM2196A0                                  | MOTOR NUT<br>FASTENING<br>BUSHING | 1.000 | PC       | VN1030A5                                 | Ø196 H81 38<br>BLADES<br>MOTOR FAN | 1.000 | PC       |  |       |    |          |                                      |       |    |
| Code      | Description                                     | Qty  | UOM        |  |   |      |             |   |       |          |   |                                   |       |          |  |                                    |       |          |  |       |    |          |                                      |       |    |
| VI1256A0  | M8 DIN 980M<br>ST. STEEL<br>SELF<br>LOCKING NUT | 1.000  | PC         |  |   |      |             |   |       |          |   |                                   |       |          |  |                                    |       |          |  |       |    |          |                                      |       |    |
| VM2196A0  | MOTOR NUT<br>FASTENING<br>BUSHING               | 1.000  | PC         |  |   |      |             |   |       |          |   |                                   |       |          |  |                                    |       |          |  |       |    |          |                                      |       |    |
| VN1030A5  | Ø196 H81 38<br>BLADES<br>MOTOR FAN              | 1.000  | PC         |  |   |      |             |   |       |          |   |                                   |       |          |  |                                    |       |          |  |       |    |          |                                      |       |    |
| VM1820A   | LATERAL<br>SUPPORTS M6<br>FIXING BOLT           |   | KVM1820A   | THUMB SCREW<br>10PCS KIT                     | <table border="1"> <thead> <tr> <th>Code</th> <th>Description</th> <th>Qty</th> <th>UOM</th> </tr> </thead> <tbody> <tr> <td>VM1820A0</td> <td>LATERAL<br/>SUPPORTS<br/>M6 FIXING<br/>BOLT</td> <td>10.000</td> <td>PC</td> </tr> </tbody> </table>   | Code | Description | Qty   | UOM   | VM1820A0 | LATERAL<br>SUPPORTS<br>M6 FIXING<br>BOLT  | 10.000                            | PC    |          |  |                                    |       |          |  |       |    |          |                                      |       |    |
| Code      | Description                                     | Qty  | UOM        |  |   |      |             |   |       |          |   |                                   |       |          |  |                                    |       |          |  |       |    |          |                                      |       |    |
| VM1820A0  | LATERAL<br>SUPPORTS<br>M6 FIXING<br>BOLT        | 10.000   | PC         |  |   |      |             |   |       |          |   |                                   |       |          |  |                                    |       |          |  |       |    |          |                                      |       |    |
| EL1361A   | D8-D10 J.G. STEAM<br>SOLENOID VALVE             |   | KEL1361A   | JG D8-D10 5+9<br>STEAM SOLENOID<br>VALVE KIT | <table border="1"> <thead> <tr> <th>Code</th> <th>Description</th> <th>Qty</th> <th>UOM</th> </tr> </thead> <tbody> <tr> <td>EL1361A0</td> <td>D8-D10 J.G.<br/>STEAM<br/>SOLENOID<br/>VALVE</td> <td>1.000</td> <td>PC</td> </tr> </tbody> </table>   | Code | Description | Qty   | UOM   | EL1361A0 | D8-D10 J.G.<br>STEAM<br>SOLENOID<br>VALVE | 1.000                             | PC    |          |  |                                    |       |          |  |       |    |          |                                      |       |    |
| Code      | Description                                     | Qty  | UOM        |  |   |      |             |   |       |          |   |                                   |       |          |  |                                    |       |          |  |       |    |          |                                      |       |    |
| EL1361A0  | D8-D10 J.G.<br>STEAM<br>SOLENOID<br>VALVE       | 1.000  | PC         |  |   |      |             |   |       |          |   |                                   |       |          |  |                                    |       |          |  |       |    |          |                                      |       |    |
| GN1326A   | ELEMENT SEALING                                 |   | KRS1274A   | 100W MOTOR<br>BRAKING ELEMENT<br>KIT         | <table border="1"> <thead> <tr> <th>Code</th> <th>Description</th> <th>Qty</th> <th>UOM</th> </tr> </thead> <tbody> <tr> <td>GN1672A1</td> <td>BREAKING<br/>ELEMENT<br/>GASKET</td> <td>1.000</td> <td>PC</td> </tr> <tr> <td>RS1274A0</td> <td>100W 60V 1<br/>TURN FLAT<br/>ELEMENT</td> <td>1.000</td> <td>PC</td> </tr> <tr> <td>SL1045A0</td> <td>S57 BLACK<br/>SILICONE -<br/>80ml<br/>CARTRIDGE</td> <td>1.000</td> <td>PC</td> </tr> <tr> <td>VI1220A1</td> <td>4,2x12 TCB<br/>SELF-TAPPIN<br/>G SCREW</td> <td>2.000</td> <td>PC</td> </tr> </tbody> </table> | Code | Description | Qty   | UOM   | GN1672A1 | BREAKING<br>ELEMENT<br>GASKET             | 1.000                             | PC    | RS1274A0 | 100W 60V 1<br>TURN FLAT<br>ELEMENT       | 1.000                              | PC    | SL1045A0 | S57 BLACK<br>SILICONE -<br>80ml<br>CARTRIDGE | 1.000 | PC | VI1220A1 | 4,2x12 TCB<br>SELF-TAPPIN<br>G SCREW | 2.000 | PC |
| Code      | Description                                     | Qty  | UOM        |  |   |      |             |   |       |          |   |                                   |       |          |  |                                    |       |          |  |       |    |          |                                      |       |    |
| GN1672A1  | BREAKING<br>ELEMENT<br>GASKET                   | 1.000  | PC         |  |   |      |             |   |       |          |   |                                   |       |          |  |                                    |       |          |  |       |    |          |                                      |       |    |
| RS1274A0  | 100W 60V 1<br>TURN FLAT<br>ELEMENT              | 1.000  | PC         |  |   |      |             |   |       |          |   |                                   |       |          |  |                                    |       |          |  |       |    |          |                                      |       |    |
| SL1045A0  | S57 BLACK<br>SILICONE -<br>80ml<br>CARTRIDGE    | 1.000  | PC         |  |   |      |             |   |       |          |   |                                   |       |          |  |                                    |       |          |  |       |    |          |                                      |       |    |
| VI1220A1  | 4,2x12 TCB<br>SELF-TAPPIN<br>G SCREW            | 2.000  | PC         |  |   |      |             |   |       |          |   |                                   |       |          |  |                                    |       |          |  |       |    |          |                                      |       |    |



| COMPONENT |                                      |   | SPARE PART |   |  |      |             |                 |       |          |                         |                             |       |          |   |                                     |       |          |                                     |                                |       |          |                                |       |    |
|-----------|--------------------------------------|---|------------|---|--|------|-------------|-----------------|-------|----------|-------------------------|-----------------------------|-------|----------|---|-------------------------------------|-------|----------|-------------------------------------|--------------------------------|-------|----------|--------------------------------|-------|----|
| Code      | Description                          | Image   | Code       | Description                             | Kit components   |      |             |                 |       |          |                         |                             |       |          |   |                                     |       |          |                                     |                                |       |          |                                |       |    |
| GN1326A   | ELEMENT SEALING                      |    | KRS1261A   | 122W MOTOR<br>BREAKING<br>ELEMENT KIT   | <table border="1"> <thead> <tr> <th>Code</th> <th>Description</th> <th>Qty</th> <th>UOM</th> </tr> </thead> <tbody> <tr> <td>GN1326A1</td> <td>ELEMENT SEALING</td> <td>1.000</td> <td>PC</td> </tr> <tr> <td>RS1261A0</td> <td>BAKERLUXCH EFLUX MOTOR BREAKING ELEMENT</td> <td>1.000</td> <td>PC</td> </tr> <tr> <td>SL1045A0</td> <td>S57 BLACK SILICONE - 80ml CARTRIDGE</td> <td>1.000</td> <td>PC</td> </tr> <tr> <td>VI1220A1</td> <td>4,2x12 TCB SELF-TAPPIN G SCREW</td> <td>2.000</td> <td>PC</td> </tr> </tbody> </table> | Code | Description | Qty             | UOM   | GN1326A1 | ELEMENT SEALING         | 1.000                       | PC    | RS1261A0 | BAKERLUXCH EFLUX MOTOR BREAKING ELEMENT | 1.000                               | PC    | SL1045A0 | S57 BLACK SILICONE - 80ml CARTRIDGE | 1.000                          | PC    | VI1220A1 | 4,2x12 TCB SELF-TAPPIN G SCREW | 2.000 | PC |
|           |                                      |   | Code       | Description                             | Qty  | UOM  |             |                 |       |          |                         |                             |       |          |   |                                     |       |          |                                     |                                |       |          |                                |       |    |
|           |                                      |   | GN1326A1   | ELEMENT SEALING                         | 1.000  | PC   |             |                 |       |          |                         |                             |       |          |   |                                     |       |          |                                     |                                |       |          |                                |       |    |
|           |                                      |   | RS1261A0   | BAKERLUXCH EFLUX MOTOR BREAKING ELEMENT | 1.000  | PC   |             |                 |       |          |                         |                             |       |          |   |                                     |       |          |                                     |                                |       |          |                                |       |    |
|           |                                      |   | SL1045A0   | S57 BLACK SILICONE - 80ml CARTRIDGE     | 1.000  | PC   |             |                 |       |          |                         |                             |       |          |   |                                     |       |          |                                     |                                |       |          |                                |       |    |
|           |                                      |   | VI1220A1   | 4,2x12 TCB SELF-TAPPIN G SCREW          | 2.000  | PC   |             |                 |       |          |                         |                             |       |          |   |                                     |       |          |                                     |                                |       |          |                                |       |    |
|           |                                      |   | KRS1215A   | 147W MOTOR<br>BRAKING ELEMENT<br>KIT    | <table border="1"> <thead> <tr> <th>Code</th> <th>Description</th> <th>Qty</th> <th>UOM</th> </tr> </thead> <tbody> <tr> <td>GN1672A1</td> <td>BREAKING ELEMENT GASKET</td> <td>1.000</td> <td>PC</td> </tr> <tr> <td>RS1215A1</td> <td>147W 105V BRAKING ELEMENT</td> <td>1.000</td> <td>PC</td> </tr> <tr> <td>SL1045A0</td> <td>S57 BLACK SILICONE - 80ml CARTRIDGE</td> <td>1.000</td> <td>PC</td> </tr> <tr> <td>VI1220A1</td> <td>4,2x12 TCB SELF-TAPPIN G SCREW</td> <td>2.000</td> <td>PC</td> </tr> </tbody> </table>       | Code | Description | Qty             | UOM   | GN1672A1 | BREAKING ELEMENT GASKET | 1.000                       | PC    | RS1215A1 | 147W 105V BRAKING ELEMENT               | 1.000                               | PC    | SL1045A0 | S57 BLACK SILICONE - 80ml CARTRIDGE | 1.000                          | PC    | VI1220A1 | 4,2x12 TCB SELF-TAPPIN G SCREW | 2.000 | PC |
|           |                                      |   | Code       | Description                             | Qty  | UOM  |             |                 |       |          |                         |                             |       |          |   |                                     |       |          |                                     |                                |       |          |                                |       |    |
|           |                                      |   | GN1672A1   | BREAKING ELEMENT GASKET                 | 1.000  | PC   |             |                 |       |          |                         |                             |       |          |   |                                     |       |          |                                     |                                |       |          |                                |       |    |
|           |                                      |   | RS1215A1   | 147W 105V BRAKING ELEMENT               | 1.000  | PC   |             |                 |       |          |                         |                             |       |          |   |                                     |       |          |                                     |                                |       |          |                                |       |    |
|           |                                      |   | SL1045A0   | S57 BLACK SILICONE - 80ml CARTRIDGE     | 1.000  | PC   |             |                 |       |          |                         |                             |       |          |   |                                     |       |          |                                     |                                |       |          |                                |       |    |
|           |                                      |   | VI1220A1   | 4,2x12 TCB SELF-TAPPIN G SCREW          | 2.000  | PC   |             |                 |       |          |                         |                             |       |          |   |                                     |       |          |                                     |                                |       |          |                                |       |    |
| KRS1095A  | 1.2kW HEATING<br>ELEMENT KIT         | <table border="1"> <thead> <tr> <th>Code</th> <th>Description</th> <th>Qty</th> <th>UOM</th> </tr> </thead> <tbody> <tr> <td>GN1326A1</td> <td>ELEMENT SEALING</td> <td>1.000</td> <td>PC</td> </tr> <tr> <td>RS1095A1</td> <td>HEATING ELEMENT 1200W 230V</td> <td>1.000</td> <td>PC</td> </tr> <tr> <td>SL1045A0</td> <td>S57 BLACK SILICONE - 80ml CARTRIDGE</td> <td>1.000</td> <td>PC</td> </tr> <tr> <td>VI1220A1</td> <td>4,2x12 TCB SELF-TAPPIN G SCREW</td> <td>2.000</td> <td>PC</td> </tr> </tbody> </table> | Code       | Description                             | Qty  | UOM  | GN1326A1    | ELEMENT SEALING | 1.000 | PC       | RS1095A1                | HEATING ELEMENT 1200W 230V  | 1.000 | PC       | SL1045A0                                | S57 BLACK SILICONE - 80ml CARTRIDGE | 1.000 | PC       | VI1220A1                            | 4,2x12 TCB SELF-TAPPIN G SCREW | 2.000 | PC       |                                |       |    |
| Code      | Description                          | Qty   | UOM        |   |  |      |             |                 |       |          |                         |                             |       |          |   |                                     |       |          |                                     |                                |       |          |                                |       |    |
| GN1326A1  | ELEMENT SEALING                      | 1.000   | PC         |   |  |      |             |                 |       |          |                         |                             |       |          |   |                                     |       |          |                                     |                                |       |          |                                |       |    |
| RS1095A1  | HEATING ELEMENT 1200W 230V           | 1.000   | PC         |   |  |      |             |                 |       |          |                         |                             |       |          |   |                                     |       |          |                                     |                                |       |          |                                |       |    |
| SL1045A0  | S57 BLACK SILICONE - 80ml CARTRIDGE  | 1.000   | PC         |   |  |      |             |                 |       |          |                         |                             |       |          |   |                                     |       |          |                                     |                                |       |          |                                |       |    |
| VI1220A1  | 4,2x12 TCB SELF-TAPPIN G SCREW       | 2.000   | PC         |   |  |      |             |                 |       |          |                         |                             |       |          |   |                                     |       |          |                                     |                                |       |          |                                |       |    |
| KRS1012A  | 1365W 120V<br>HEATING ELEMENT<br>KIT | <table border="1"> <thead> <tr> <th>Code</th> <th>Description</th> <th>Qty</th> <th>UOM</th> </tr> </thead> <tbody> <tr> <td>GN1326A1</td> <td>ELEMENT SEALING</td> <td>1.000</td> <td>PC</td> </tr> <tr> <td>RS1012A0</td> <td>CIRCULAR ELEMENT 1365W 120V</td> <td>1.000</td> <td>PC</td> </tr> <tr> <td>VI1220A1</td> <td>4,2x12 TCB SELF-TAPPIN G SCREW</td> <td>5.000</td> <td>PC</td> </tr> </tbody> </table>   | Code       | Description                             | Qty  | UOM  | GN1326A1    | ELEMENT SEALING | 1.000 | PC       | RS1012A0                | CIRCULAR ELEMENT 1365W 120V | 1.000 | PC       | VI1220A1                                | 4,2x12 TCB SELF-TAPPIN G SCREW      | 5.000 | PC       |                                     |                                |       |          |                                |       |    |
| Code      | Description                          | Qty   | UOM        |   |  |      |             |                 |       |          |                         |                             |       |          |   |                                     |       |          |                                     |                                |       |          |                                |       |    |
| GN1326A1  | ELEMENT SEALING                      | 1.000   | PC         |   |  |      |             |                 |       |          |                         |                             |       |          |   |                                     |       |          |                                     |                                |       |          |                                |       |    |
| RS1012A0  | CIRCULAR ELEMENT 1365W 120V          | 1.000   | PC         |   |  |      |             |                 |       |          |                         |                             |       |          |   |                                     |       |          |                                     |                                |       |          |                                |       |    |
| VI1220A1  | 4,2x12 TCB SELF-TAPPIN G SCREW       | 5.000   | PC         |   |  |      |             |                 |       |          |                         |                             |       |          |   |                                     |       |          |                                     |                                |       |          |                                |       |    |

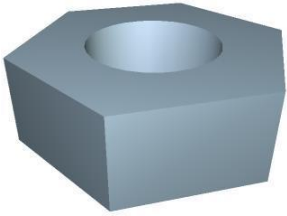

| COMPONENT |                                     |   | SPARE PART |                                  |   |      |             |                 |       |          |                 |                                   |       |          |                                |                                |       |          |                                     |                          |       |          |                                |            |       |    |
|-----------|-------------------------------------|---|------------|----------------------------------|---|------|-------------|-----------------|-------|----------|-----------------|-----------------------------------|-------|----------|--------------------------------|--------------------------------|-------|----------|-------------------------------------|--------------------------|-------|----------|--------------------------------|------------|-------|----|
| Code      | Description                         | Image   | Code       | Description                      | Kit components  |      |             |                 |       |          |                 |                                   |       |          |                                |                                |       |          |                                     |                          |       |          |                                |            |       |    |
| GN1326A   | ELEMENT SEALING                     |    | KRS1011A   | ROBERTA/LISA HEATING ELEMENT KIT | <table border="1"> <thead> <tr> <th>Code</th> <th>Description</th> <th>Qty</th> <th>UOM</th> </tr> </thead> <tbody> <tr> <td>GN1326A1</td> <td>ELEMENT SEALING</td> <td>1.000</td> <td>PC</td> </tr> <tr> <td>RS1011A0</td> <td>2560W 220-230V HEATING ELEMENT</td> <td>1.000</td> <td>PC</td> </tr> <tr> <td>SL1045A0</td> <td>S57 BLACK SILICONE - 80ml CARTRIDGE</td> <td>1.000</td> <td>PC</td> </tr> <tr> <td>VI1220A1</td> <td>4,2x12 TCB SELF-TAPPIN G SCREW</td> <td>5.000</td> <td>PC</td> </tr> </tbody> </table> | Code | Description | Qty             | UOM   | GN1326A1 | ELEMENT SEALING | 1.000                             | PC    | RS1011A0 | 2560W 220-230V HEATING ELEMENT | 1.000                          | PC    | SL1045A0 | S57 BLACK SILICONE - 80ml CARTRIDGE | 1.000                    | PC    | VI1220A1 | 4,2x12 TCB SELF-TAPPIN G SCREW | 5.000      | PC    |    |
|           |                                     |   | Code       | Description                      | Qty   | UOM  |             |                 |       |          |                 |                                   |       |          |                                |                                |       |          |                                     |                          |       |          |                                |            |       |    |
|           |                                     |   | GN1326A1   | ELEMENT SEALING                  | 1.000   | PC   |             |                 |       |          |                 |                                   |       |          |                                |                                |       |          |                                     |                          |       |          |                                |            |       |    |
|           |                                     |   | RS1011A0   | 2560W 220-230V HEATING ELEMENT   | 1.000   | PC   |             |                 |       |          |                 |                                   |       |          |                                |                                |       |          |                                     |                          |       |          |                                |            |       |    |
| SL1045A0  | S57 BLACK SILICONE - 80ml CARTRIDGE | 1.000   | PC         |                                  |   |      |             |                 |       |          |                 |                                   |       |          |                                |                                |       |          |                                     |                          |       |          |                                |            |       |    |
| VI1220A1  | 4,2x12 TCB SELF-TAPPIN G SCREW      | 5.000   | PC         |                                  |   |      |             |                 |       |          |                 |                                   |       |          |                                |                                |       |          |                                     |                          |       |          |                                |            |       |    |
| KRS0090A  | HEATING ELEMENT 1.26kW              | <table border="1"> <thead> <tr> <th>Code</th> <th>Description</th> <th>Qty</th> <th>UOM</th> </tr> </thead> <tbody> <tr> <td>GN1326A1</td> <td>ELEMENT SEALING</td> <td>1.000</td> <td>PC</td> </tr> <tr> <td>RS0090A0</td> <td>CIRC. HEAT. ELEMENT 1260W 220-230</td> <td>1.000</td> <td>PC</td> </tr> <tr> <td>VI1220A1</td> <td>4,2x12 TCB SELF-TAPPIN G SCREW</td> <td>3.000</td> <td>PC</td> </tr> <tr> <td>VM1794A0</td> <td>250x4.8 PA66 BLACK CLAMP</td> <td>2.000</td> <td>PC</td> </tr> <tr> <td>VM2103A0</td> <td>CLAMP LOCK</td> <td>2.000</td> <td>PC</td> </tr> </tbody> </table> | Code       | Description                      | Qty   | UOM  | GN1326A1    | ELEMENT SEALING | 1.000 | PC       | RS0090A0        | CIRC. HEAT. ELEMENT 1260W 220-230 | 1.000 | PC       | VI1220A1                       | 4,2x12 TCB SELF-TAPPIN G SCREW | 3.000 | PC       | VM1794A0                            | 250x4.8 PA66 BLACK CLAMP | 2.000 | PC       | VM2103A0                       | CLAMP LOCK | 2.000 | PC |
| Code      | Description                         | Qty   | UOM        |                                  |   |      |             |                 |       |          |                 |                                   |       |          |                                |                                |       |          |                                     |                          |       |          |                                |            |       |    |
| GN1326A1  | ELEMENT SEALING                     | 1.000   | PC         |                                  |   |      |             |                 |       |          |                 |                                   |       |          |                                |                                |       |          |                                     |                          |       |          |                                |            |       |    |
| RS0090A0  | CIRC. HEAT. ELEMENT 1260W 220-230   | 1.000   | PC         |                                  |   |      |             |                 |       |          |                 |                                   |       |          |                                |                                |       |          |                                     |                          |       |          |                                |            |       |    |
| VI1220A1  | 4,2x12 TCB SELF-TAPPIN G SCREW      | 3.000   | PC         |                                  |   |      |             |                 |       |          |                 |                                   |       |          |                                |                                |       |          |                                     |                          |       |          |                                |            |       |    |
| VM1794A0  | 250x4.8 PA66 BLACK CLAMP            | 2.000   | PC         |                                  |   |      |             |                 |       |          |                 |                                   |       |          |                                |                                |       |          |                                     |                          |       |          |                                |            |       |    |
| VM2103A0  | CLAMP LOCK                          | 2.000   | PC         |                                  |   |      |             |                 |       |          |                 |                                   |       |          |                                |                                |       |          |                                     |                          |       |          |                                |            |       |    |
| KRS0050A  | HEATING ELEMENT KIT 0.5kW           | <table border="1"> <thead> <tr> <th>Code</th> <th>Description</th> <th>Qty</th> <th>UOM</th> </tr> </thead> <tbody> <tr> <td>GN1326A1</td> <td>ELEMENT SEALING</td> <td>1.000</td> <td>PC</td> </tr> <tr> <td>RS0050A0</td> <td>HEAT. ELEMENT 500W 220-230V LIEV</td> <td>1.000</td> <td>PC</td> </tr> <tr> <td>VI1220A1</td> <td>4,2x12 TCB SELF-TAPPIN G SCREW</td> <td>2.000</td> <td>PC</td> </tr> </tbody> </table>  | Code       | Description                      | Qty   | UOM  | GN1326A1    | ELEMENT SEALING | 1.000 | PC       | RS0050A0        | HEAT. ELEMENT 500W 220-230V LIEV  | 1.000 | PC       | VI1220A1                       | 4,2x12 TCB SELF-TAPPIN G SCREW | 2.000 | PC       |                                     |                          |       |          |                                |            |       |    |
| Code      | Description                         | Qty   | UOM        |                                  |   |      |             |                 |       |          |                 |                                   |       |          |                                |                                |       |          |                                     |                          |       |          |                                |            |       |    |
| GN1326A1  | ELEMENT SEALING                     | 1.000   | PC         |                                  |   |      |             |                 |       |          |                 |                                   |       |          |                                |                                |       |          |                                     |                          |       |          |                                |            |       |    |
| RS0050A0  | HEAT. ELEMENT 500W 220-230V LIEV    | 1.000   | PC         |                                  |   |      |             |                 |       |          |                 |                                   |       |          |                                |                                |       |          |                                     |                          |       |          |                                |            |       |    |
| VI1220A1  | 4,2x12 TCB SELF-TAPPIN G SCREW      | 2.000   | PC         |                                  |   |      |             |                 |       |          |                 |                                   |       |          |                                |                                |       |          |                                     |                          |       |          |                                |            |       |    |
| KRS0011A  | HEATING ELEMENT 1.465kW RS0011A     | <table border="1"> <thead> <tr> <th>Code</th> <th>Description</th> <th>Qty</th> <th>UOM</th> </tr> </thead> <tbody> <tr> <td>GN1326A1</td> <td>ELEMENT SEALING</td> <td>1.000</td> <td>PC</td> </tr> <tr> <td>RS0011A0</td> <td>CIRC.HEAT. ELEMENT 1465W 220-230</td> <td>1.000</td> <td>PC</td> </tr> <tr> <td>VI1220A1</td> <td>4,2x12 TCB SELF-TAPPIN G SCREW</td> <td>3.000</td> <td>PC</td> </tr> <tr> <td>VM1794A0</td> <td>250x4.8 PA66 BLACK CLAMP</td> <td>2.000</td> <td>PC</td> </tr> <tr> <td>VM2103A0</td> <td>CLAMP LOCK</td> <td>2.000</td> <td>PC</td> </tr> </tbody> </table>  | Code       | Description                      | Qty   | UOM  | GN1326A1    | ELEMENT SEALING | 1.000 | PC       | RS0011A0        | CIRC.HEAT. ELEMENT 1465W 220-230  | 1.000 | PC       | VI1220A1                       | 4,2x12 TCB SELF-TAPPIN G SCREW | 3.000 | PC       | VM1794A0                            | 250x4.8 PA66 BLACK CLAMP | 2.000 | PC       | VM2103A0                       | CLAMP LOCK | 2.000 | PC |
| Code      | Description                         | Qty   | UOM        |                                  |   |      |             |                 |       |          |                 |                                   |       |          |                                |                                |       |          |                                     |                          |       |          |                                |            |       |    |
| GN1326A1  | ELEMENT SEALING                     | 1.000   | PC         |                                  |   |      |             |                 |       |          |                 |                                   |       |          |                                |                                |       |          |                                     |                          |       |          |                                |            |       |    |
| RS0011A0  | CIRC.HEAT. ELEMENT 1465W 220-230    | 1.000   | PC         |                                  |   |      |             |                 |       |          |                 |                                   |       |          |                                |                                |       |          |                                     |                          |       |          |                                |            |       |    |
| VI1220A1  | 4,2x12 TCB SELF-TAPPIN G SCREW      | 3.000   | PC         |                                  |   |      |             |                 |       |          |                 |                                   |       |          |                                |                                |       |          |                                     |                          |       |          |                                |            |       |    |
| VM1794A0  | 250x4.8 PA66 BLACK CLAMP            | 2.000   | PC         |                                  |   |      |             |                 |       |          |                 |                                   |       |          |                                |                                |       |          |                                     |                          |       |          |                                |            |       |    |
| VM2103A0  | CLAMP LOCK                          | 2.000   | PC         |                                  |   |      |             |                 |       |          |                 |                                   |       |          |                                |                                |       |          |                                     |                          |       |          |                                |            |       |    |
| KRS0010A  | KIT HEATING ELEMENT RS10010A        | <table border="1"> <thead> <tr> <th>Code</th> <th>Description</th> <th>Qty</th> <th>UOM</th> </tr> </thead> <tbody> <tr> <td>GN1326A1</td> <td>ELEMENT SEALING</td> <td>1.000</td> <td>PC</td> </tr> </tbody> </table>  | Code       | Description                      | Qty   | UOM  | GN1326A1    | ELEMENT SEALING | 1.000 | PC       |                 |                                   |       |          |                                |                                |       |          |                                     |                          |       |          |                                |            |       |    |
| Code      | Description                         | Qty   | UOM        |                                  |   |      |             |                 |       |          |                 |                                   |       |          |                                |                                |       |          |                                     |                          |       |          |                                |            |       |    |
| GN1326A1  | ELEMENT SEALING                     | 1.000   | PC         |                                  |   |      |             |                 |       |          |                 |                                   |       |          |                                |                                |       |          |                                     |                          |       |          |                                |            |       |    |

| COMPONENT |   |  | SPARE PART |  |   |                                   |             |                    |       |          |   |        |    |          |                                      |       |    |          |  |       |    |          |                                      |       |    |
|-----------|---|--|------------|--|---|-----------------------------------|-------------|--------------------|-------|----------|---|--------|----|----------|--------------------------------------|-------|----|----------|--|-------|----|----------|--------------------------------------|-------|----|
| Code      | Description                                   | Image  | Code       | Description                                  | Kit components  |                                   |             |                    |       |          |   |        |    |          |                                      |       |    |          |  |       |    |          |                                      |       |    |
| GN1326A   | ELEMENT SEALING                               |   | KRS0010A   | KIT HEATING<br>ELEMENT RS10010A              | <table border="1"> <thead> <tr> <th>Code</th> <th>Description</th> <th>Qty</th> <th>UOM</th> </tr> </thead> <tbody> <tr> <td>RS0010A0</td> <td>CIRC.HEAT.<br/>ELEMENT<br/>2560W -<br/>220-230 V</td> <td>1.000</td> <td>PC</td> </tr> <tr> <td>VI1220A1</td> <td>4,2x12 TCB<br/>SELF-TAPPIN<br/>G SCREW</td> <td>3.000</td> <td>PC</td> </tr> </tbody> </table>   | Code                              | Description | Qty                | UOM   | RS0010A0 | CIRC.HEAT.<br>ELEMENT<br>2560W -<br>220-230 V | 1.000  | PC | VI1220A1 | 4,2x12 TCB<br>SELF-TAPPIN<br>G SCREW | 3.000 | PC |          |  |       |    |          |                                      |       |    |
|           |   |  | Code       | Description                                  | Qty   | UOM                               |             |                    |       |          |   |        |    |          |                                      |       |    |          |  |       |    |          |                                      |       |    |
| RS0010A0  | CIRC.HEAT.<br>ELEMENT<br>2560W -<br>220-230 V | 1.000  | PC         |  |   |                                   |             |                    |       |          |   |        |    |          |                                      |       |    |          |  |       |    |          |                                      |       |    |
| VI1220A1  | 4,2x12 TCB<br>SELF-TAPPIN<br>G SCREW          | 3.000  | PC         |  |   |                                   |             |                    |       |          |   |        |    |          |                                      |       |    |          |  |       |    |          |                                      |       |    |
| KGN1326A  | HEATING ELEMENT<br>GASKET 5 PCS KIT           | <table border="1"> <thead> <tr> <th>Code</th> <th>Description</th> <th>Qty</th> <th>UOM</th> </tr> </thead> <tbody> <tr> <td>GN1326A1</td> <td>ELEMENT<br/>SEALING</td> <td>5.000</td> <td>PC</td> </tr> </tbody> </table> | Code       | Description                                  | Qty   | UOM                               | GN1326A1    | ELEMENT<br>SEALING | 5.000 | PC       |   |        |    |          |                                      |       |    |          |  |       |    |          |                                      |       |    |
| Code      | Description                                   | Qty  | UOM        |  |   |                                   |             |                    |       |          |   |        |    |          |                                      |       |    |          |  |       |    |          |                                      |       |    |
| GN1326A1  | ELEMENT<br>SEALING                            | 5.000  | PC         |  |   |                                   |             |                    |       |          |   |        |    |          |                                      |       |    |          |  |       |    |          |                                      |       |    |
| GN1342C   | XBC605E DOOR<br>GASKET - GN1006A              |    | KGN1663A   | 600-1200 SERIES/CL<br>500 DOOR GASKET<br>KIT | <table border="1"> <thead> <tr> <th>Code</th> <th>Description</th> <th>Qty</th> <th>UOM</th> </tr> </thead> <tbody> <tr> <td>GN1626A0</td> <td>DOUBLE<br/>LIP-TYPE<br/>FRONT GASKE</td> <td>2.510</td> <td>M</td> </tr> <tr> <td>SL1025A0</td> <td>CLEAR<br/>SILICON DOW<br/>CORNING 734</td> <td>0.012</td> <td>PC</td> </tr> <tr> <td>VM2277A0</td> <td>DOOR SEAL<br/>KIT INTERNAL<br/>CONNECTION</td> <td>1.000</td> <td>PC</td> </tr> </tbody> </table>   | Code                              | Description | Qty                | UOM   | GN1626A0 | DOUBLE<br>LIP-TYPE<br>FRONT GASKE             | 2.510  | M  | SL1025A0 | CLEAR<br>SILICON DOW<br>CORNING 734  | 0.012 | PC | VM2277A0 | DOOR SEAL<br>KIT INTERNAL<br>CONNECTION      | 1.000 | PC |          |                                      |       |    |
|           |   |  |            |  | Code  | Description                       | Qty         | UOM                |       |          |   |        |    |          |                                      |       |    |          |  |       |    |          |                                      |       |    |
|           |   |  |            |  | GN1626A0  | DOUBLE<br>LIP-TYPE<br>FRONT GASKE | 2.510       | M                  |       |          |   |        |    |          |                                      |       |    |          |  |       |    |          |                                      |       |    |
| SL1025A0  | CLEAR<br>SILICON DOW<br>CORNING 734           | 0.012  | PC         |  |   |                                   |             |                    |       |          |   |        |    |          |                                      |       |    |          |  |       |    |          |                                      |       |    |
| VM2277A0  | DOOR SEAL<br>KIT INTERNAL<br>CONNECTION       | 1.000  | PC         |  |   |                                   |             |                    |       |          |   |        |    |          |                                      |       |    |          |  |       |    |          |                                      |       |    |
| RC1170A   | M14 H=7 CH=22<br>STAINLESS STEEL<br>NUT       |   | KRC1170A   | M14 H8 CH22 NUT -<br>10 PCS. KIT             | <table border="1"> <thead> <tr> <th>Code</th> <th>Description</th> <th>Qty</th> <th>UOM</th> </tr> </thead> <tbody> <tr> <td>RC1170A1</td> <td>M14 H=7<br/>CH=22<br/>STAINLESS<br/>STEEL NUT</td> <td>10.000</td> <td>PC</td> </tr> </tbody> </table>   | Code                              | Description | Qty                | UOM   | RC1170A1 | M14 H=7<br>CH=22<br>STAINLESS<br>STEEL NUT    | 10.000 | PC |          |                                      |       |    |          |  |       |    |          |                                      |       |    |
| Code      | Description                                   | Qty  | UOM        |  |   |                                   |             |                    |       |          |   |        |    |          |                                      |       |    |          |  |       |    |          |                                      |       |    |
| RC1170A1  | M14 H=7<br>CH=22<br>STAINLESS<br>STEEL NUT    | 10.000   | PC         |  |   |                                   |             |                    |       |          |   |        |    |          |                                      |       |    |          |  |       |    |          |                                      |       |    |
| RS1150A   | 4,9kW HEATING<br>ELEMENT                      |   | KRS1150A   | 4.9kW HEATING<br>ELEMENT KIT                 | <table border="1"> <thead> <tr> <th>Code</th> <th>Description</th> <th>Qty</th> <th>UOM</th> </tr> </thead> <tbody> <tr> <td>GN1327A0</td> <td>HEATING<br/>ELEMENT<br/>GASKET</td> <td>1.000</td> <td>PC</td> </tr> <tr> <td>RS1150A0</td> <td>4,9kW<br/>HEATING<br/>ELEMENT</td> <td>1.000</td> <td>PC</td> </tr> <tr> <td>SL1045A0</td> <td>S57 BLACK<br/>SILICONE -<br/>80ml<br/>CARTRIDGE</td> <td>1.000</td> <td>PC</td> </tr> <tr> <td>VI1220A1</td> <td>4,2x12 TCB<br/>SELF-TAPPIN<br/>G SCREW</td> <td>5.000</td> <td>PC</td> </tr> </tbody> </table> | Code                              | Description | Qty                | UOM   | GN1327A0 | HEATING<br>ELEMENT<br>GASKET                  | 1.000  | PC | RS1150A0 | 4,9kW<br>HEATING<br>ELEMENT          | 1.000 | PC | SL1045A0 | S57 BLACK<br>SILICONE -<br>80ml<br>CARTRIDGE | 1.000 | PC | VI1220A1 | 4,2x12 TCB<br>SELF-TAPPIN<br>G SCREW | 5.000 | PC |
|           |   |  |            |  | Code  | Description                       | Qty         | UOM                |       |          |   |        |    |          |                                      |       |    |          |  |       |    |          |                                      |       |    |
|           |   |  |            |  | GN1327A0  | HEATING<br>ELEMENT<br>GASKET      | 1.000       | PC                 |       |          |   |        |    |          |                                      |       |    |          |  |       |    |          |                                      |       |    |
|           |   |  |            |  | RS1150A0  | 4,9kW<br>HEATING<br>ELEMENT       | 1.000       | PC                 |       |          |   |        |    |          |                                      |       |    |          |  |       |    |          |                                      |       |    |
| SL1045A0  | S57 BLACK<br>SILICONE -<br>80ml<br>CARTRIDGE  | 1.000  | PC         |  |   |                                   |             |                    |       |          |   |        |    |          |                                      |       |    |          |  |       |    |          |                                      |       |    |
| VI1220A1  | 4,2x12 TCB<br>SELF-TAPPIN<br>G SCREW          | 5.000  | PC         |  |   |                                   |             |                    |       |          |   |        |    |          |                                      |       |    |          |  |       |    |          |                                      |       |    |

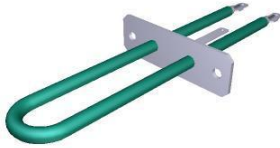

| COMPONENT |  |  | SPARE PART |                                   |  |      |             |     |     |          |                 |       |    |          |  |       |    |          |                                     |       |    |          |                               |       |    |
|-----------|--|--|------------|-----------------------------------|--|------|-------------|-----|-----|----------|-----------------|-------|----|----------|--|-------|----|----------|-------------------------------------|-------|----|----------|-------------------------------|-------|----|
| Code      | Description                            | Image  | Code       | Description                       | Kit components   |      |             |     |     |          |                 |       |    |          |  |       |    |          |                                     |       |    |          |                               |       |    |
| RS1261A   | BAKERLUXCHEFLUX MOTOR BREAKING ELEMEN  |   | KRS1261A   | 122W MOTOR BREAKING ELEMENT KIT   | <table border="1"> <thead> <tr> <th>Code</th> <th>Description</th> <th>Qty</th> <th>UOM</th> </tr> </thead> <tbody> <tr> <td>GN1326A1</td> <td>ELEMENT SEALING</td> <td>1.000</td> <td>PC</td> </tr> <tr> <td>RS1261A0</td> <td>BAKERLUXCHEFLUX MOTOR BREAKING ELEMENT</td> <td>1.000</td> <td>PC</td> </tr> <tr> <td>SL1045A0</td> <td>S57 BLACK SILICONE - 80ml CARTRIDGE</td> <td>1.000</td> <td>PC</td> </tr> <tr> <td>VI1220A1</td> <td>4,2x12 TCB SELF-TAPPING SCREW</td> <td>2.000</td> <td>PC</td> </tr> </tbody> </table> | Code | Description | Qty | UOM | GN1326A1 | ELEMENT SEALING | 1.000 | PC | RS1261A0 | BAKERLUXCHEFLUX MOTOR BREAKING ELEMENT | 1.000 | PC | SL1045A0 | S57 BLACK SILICONE - 80ml CARTRIDGE | 1.000 | PC | VI1220A1 | 4,2x12 TCB SELF-TAPPING SCREW | 2.000 | PC |
| Code      | Description                            | Qty  | UOM        |                                   |  |      |             |     |     |          |                 |       |    |          |  |       |    |          |                                     |       |    |          |                               |       |    |
| GN1326A1  | ELEMENT SEALING                        | 1.000  | PC         |                                   |  |      |             |     |     |          |                 |       |    |          |  |       |    |          |                                     |       |    |          |                               |       |    |
| RS1261A0  | BAKERLUXCHEFLUX MOTOR BREAKING ELEMENT | 1.000  | PC         |                                   |  |      |             |     |     |          |                 |       |    |          |  |       |    |          |                                     |       |    |          |                               |       |    |
| SL1045A0  | S57 BLACK SILICONE - 80ml CARTRIDGE    | 1.000  | PC         |                                   |  |      |             |     |     |          |                 |       |    |          |  |       |    |          |                                     |       |    |          |                               |       |    |
| VI1220A1  | 4,2x12 TCB SELF-TAPPING SCREW          | 2.000  | PC         |                                   |  |      |             |     |     |          |                 |       |    |          |  |       |    |          |                                     |       |    |          |                               |       |    |
| TB1515A   | EXTERNAL HUMIDITY PIPE + RC1165A0      |  | TB1515A1   | EXTERNAL HUMIDITY PIPE + RC1165A0 |  |      |             |     |     |          |                 |       |    |          |  |       |    |          |                                     |       |    |          |                               |       |    |



**ASM2750A/0.D01 - External cover - FRONT**











**ASM2750A/0.D01 - External cover - REAR**

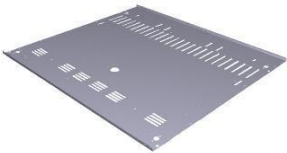
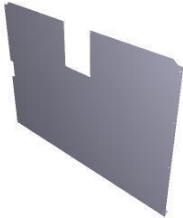



| COMPONENT |   |   | SPARE PART |   |                |
|-----------|---|---|------------|---|----------------|
| Code      | Description                                     | Image   | Code       | Description                                     | Kit components |
| 0D2125A   | BAKERLUX<br>CHEFLUX COVER                       |    | 0D2125A0   | BAKERLUX<br>CHEFLUX COVER                       |                |
| 0D2207A   | CHEF-BAKERLUX<br>EXTERNAL LEFT<br>SIDE PANEL    |    | 0D2207A0   | CHEF-BAKERLUX<br>EXTERNAL LEFT<br>SIDE PANEL    |                |
| 0D2208A   | CHEF-BAKERLUX<br>EXTERNAL RIGHT<br>SIDE PANEL   |  | 0D2208A0   | CHEF-BAKERLUX<br>EXTERNAL RIGHT<br>SIDE PANEL   |                |
| 0E1331C   | BAKERLUX<br>CHEFLUX<br>EXTERNAL BOTTOM<br>PANEL |  | 0E1331C0   | BAKERLUX<br>CHEFLUX<br>EXTERNAL BOTTOM<br>PANEL |                |
| 0F1468A   | XB69- XV59-<br>EXTERNAL BACK<br>PANEL           |  | 0F1468A0   | XB69- XV59-<br>EXTERNAL BACK<br>PANEL           |                |

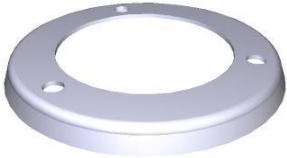

| COMPONENT |  |   | SPARE PART |  |                |
|-----------|--|---|------------|--|----------------|
| Code      | Description                                    | Image   | Code       | Description                                    | Kit components |
| 0H1450A   | XB-XV-XG ST.<br>STEEL MUFFLE<br>FRONT CORNER   |    | 0H1450A0   | XB-XV-XG ST.<br>STEEL MUFFLE<br>FRONT CORNER   |                |
| 0H2560A   | XBC/XVC ZINC<br>PLAT. DOOR<br>COUNTERBRACKET   |    | 0H2560A0   | XBC/XVC ZINC<br>PLAT. DOOR<br>COUNTERBRACKET   |                |
| 0H3790A   | CHIMNEY HOLDING<br>PLATE                       |  | 0H3790A0   | CHIMNEY HOLDING<br>PLATE                       |                |
| 0H6240A   | BAKERLUX<br>CHEFLUX ST. STEEL<br>CONTROL PANEL |  | 0H6240A0   | BAKERLUX<br>CHEFLUX ST. STEEL<br>CONTROL PANEL |                |
| 0H6333A   | BL CL THREADED<br>DOOR COUNTER<br>BRACKET      |  | 0H6333A0   | BL CL THREADED<br>DOOR COUNTER<br>BRACKET      |                |



| COMPONENT |   |   | SPARE PART |                                      |  |      |             |     |     |          |  |       |    |          |   |       |    |          |                                |       |    |
|-----------|---|---|------------|--------------------------------------|--|------|-------------|-----|-----|----------|--|-------|----|----------|---|-------|----|----------|--------------------------------|-------|----|
| Code      | Description                               | Image   | Code       | Description                          | Kit components   |      |             |     |     |          |  |       |    |          |   |       |    |          |                                |       |    |
| PD1074A   | H=100 SQUARE FOO                          |    | KPD1074A   | Mind.Maps H100 FOOT KIT              | <table border="1"> <thead> <tr> <th>Code</th> <th>Description</th> <th>Qty</th> <th>UOM</th> </tr> </thead> <tbody> <tr> <td>PD1074A0</td> <td>H=100 SQUARE FOO</td> <td>1.000</td> <td>PC</td> </tr> <tr> <td>PD1075A1</td> <td>PD1074 FOOT LOCKING BRACKET</td> <td>1.000</td> <td>PC</td> </tr> <tr> <td>VI1220A1</td> <td>4,2x12 TCB SELF-TAPPIN G SCREW</td> <td>5.000</td> <td>PC</td> </tr> </tbody> </table> | Code | Description | Qty | UOM | PD1074A0 | H=100 SQUARE FOO                       | 1.000 | PC | PD1075A1 | PD1074 FOOT LOCKING BRACKET               | 1.000 | PC | VI1220A1 | 4,2x12 TCB SELF-TAPPIN G SCREW | 5.000 | PC |
| Code      | Description                               | Qty   | UOM        |                                      |  |      |             |     |     |          |  |       |    |          |   |       |    |          |                                |       |    |
| PD1074A0  | H=100 SQUARE FOO                          | 1.000   | PC         |                                      |  |      |             |     |     |          |  |       |    |          |   |       |    |          |                                |       |    |
| PD1075A1  | PD1074 FOOT LOCKING BRACKET               | 1.000   | PC         |                                      |  |      |             |     |     |          |  |       |    |          |   |       |    |          |                                |       |    |
| VI1220A1  | 4,2x12 TCB SELF-TAPPIN G SCREW            | 5.000   | PC         |                                      |  |      |             |     |     |          |  |       |    |          |   |       |    |          |                                |       |    |
| PD1075A   | PD1074 FOOT LOCKING BRACKET               |   | KPD1075A   | OVEN FOOT STOPPING BRACKET 4 PCS KIT | <table border="1"> <thead> <tr> <th>Code</th> <th>Description</th> <th>Qty</th> <th>UOM</th> </tr> </thead> <tbody> <tr> <td>PD1075A1</td> <td>PD1074 FOOT LOCKING BRACKET</td> <td>4.000</td> <td>PC</td> </tr> <tr> <td>VI1950A0</td> <td>ST. STEEL 4,2X13 TCB SELF-DRILLIN G SCREW</td> <td>8.000</td> <td>PC</td> </tr> </tbody> </table>  | Code | Description | Qty | UOM | PD1075A1 | PD1074 FOOT LOCKING BRACKET            | 4.000 | PC | VI1950A0 | ST. STEEL 4,2X13 TCB SELF-DRILLIN G SCREW | 8.000 | PC |          |                                |       |    |
| Code      | Description                               | Qty   | UOM        |                                      |  |      |             |     |     |          |  |       |    |          |   |       |    |          |                                |       |    |
| PD1075A1  | PD1074 FOOT LOCKING BRACKET               | 4.000   | PC         |                                      |  |      |             |     |     |          |  |       |    |          |   |       |    |          |                                |       |    |
| VI1950A0  | ST. STEEL 4,2X13 TCB SELF-DRILLIN G SCREW | 8.000   | PC         |                                      |  |      |             |     |     |          |  |       |    |          |   |       |    |          |                                |       |    |
| MN1111A   | CHEFLUX BAKERLUX THERMOSTAT KNO           |  | KMN1111A   | CL/BL THERMOSTAT KNOB (CELSIUS)      | <table border="1"> <thead> <tr> <th>Code</th> <th>Description</th> <th>Qty</th> <th>UOM</th> </tr> </thead> <tbody> <tr> <td>MN1111A1</td> <td>CHEFLUX BAKERLUX THERMOSTAT KNOB</td> <td>1.000</td> <td>PC</td> </tr> </tbody> </table>  | Code | Description | Qty | UOM | MN1111A1 | CHEFLUX BAKERLUX THERMOSTAT KNOB       | 1.000 | PC |          |   |       |    |          |                                |       |    |
| Code      | Description                               | Qty   | UOM        |                                      |  |      |             |     |     |          |  |       |    |          |   |       |    |          |                                |       |    |
| MN1111A1  | CHEFLUX BAKERLUX THERMOSTAT KNOB          | 1.000   | PC         |                                      |  |      |             |     |     |          |  |       |    |          |   |       |    |          |                                |       |    |
| MN1112A   | CHEFLUX BAKERLUX TIMER KNOB               |  | KMN1112A   | CHEFLUX/BAKERLUX X TIMER KNOB KIT    | <table border="1"> <thead> <tr> <th>Code</th> <th>Description</th> <th>Qty</th> <th>UOM</th> </tr> </thead> <tbody> <tr> <td>MN1112A1</td> <td>CHEFLUX BAKERLUX TIMER KNOB</td> <td>1.000</td> <td>PC</td> </tr> </tbody> </table>   | Code | Description | Qty | UOM | MN1112A1 | CHEFLUX BAKERLUX TIMER KNOB            | 1.000 | PC |          |   |       |    |          |                                |       |    |
| Code      | Description                               | Qty   | UOM        |                                      |  |      |             |     |     |          |  |       |    |          |   |       |    |          |                                |       |    |
| MN1112A1  | CHEFLUX BAKERLUX TIMER KNOB               | 1.000   | PC         |                                      |  |      |             |     |     |          |  |       |    |          |   |       |    |          |                                |       |    |
| MN1113A   | CHEFLUX BAKERLUX HUMIDITY CONTROL KNOB    |  | KMN1113A   | CL/BL HUMIDITY CONTROL KNOB KIT      | <table border="1"> <thead> <tr> <th>Code</th> <th>Description</th> <th>Qty</th> <th>UOM</th> </tr> </thead> <tbody> <tr> <td>MN1113A2</td> <td>CHEFLUX BAKERLUX HUMIDITY CONTROL KNOB</td> <td>1.000</td> <td>PC</td> </tr> </tbody> </table>  | Code | Description | Qty | UOM | MN1113A2 | CHEFLUX BAKERLUX HUMIDITY CONTROL KNOB | 1.000 | PC |          |   |       |    |          |                                |       |    |
| Code      | Description                               | Qty   | UOM        |                                      |  |      |             |     |     |          |  |       |    |          |   |       |    |          |                                |       |    |
| MN1113A2  | CHEFLUX BAKERLUX HUMIDITY CONTROL KNOB    | 1.000   | PC         |                                      |  |      |             |     |     |          |  |       |    |          |   |       |    |          |                                |       |    |



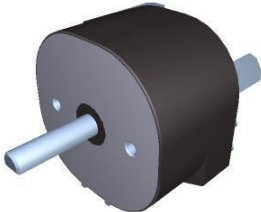
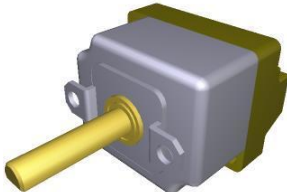
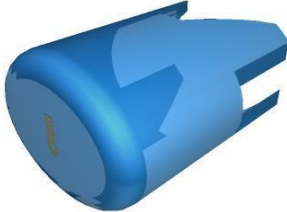

| COMPONENT |   |   | SPARE PART |   |   |                                      |             |     |     |          |   |       |    |          |                                   |       |    |          |                |       |    |          |                    |       |    |          |                               |       |    |
|-----------|---|---|------------|---|---|--------------------------------------|-------------|-----|-----|----------|---|-------|----|----------|-----------------------------------|-------|----|----------|----------------|-------|----|----------|--------------------|-------|----|----------|-------------------------------|-------|----|
| Code      | Description                                   | Image   | Code       | Description                             | Kit components  |                                      |             |     |     |          |   |       |    |          |                                   |       |    |          |                |       |    |          |                    |       |    |          |                               |       |    |
| TM1001C   | 15 SEC 120/240V<br>BUZZER KIT                 |    | KTM1001C   | 15 SEC BUZZER KIT                       | <table border="1"> <thead> <tr> <th>Code</th> <th>Description</th> <th>Qty</th> <th>UOM</th> </tr> </thead> <tbody> <tr> <td>TM1001C3</td> <td>15 SEC 120/240V BUZZER KIT</td> <td>1.000</td> <td>PC</td> </tr> <tr> <td>VI1220A1</td> <td>4,2x12 TCB SELF-TAPPING SCREW</td> <td>3.000</td> <td>PC</td> </tr> <tr> <td>VI1850A0</td> <td>TCB M4x6 SCREW</td> <td>3.000</td> <td>PC</td> </tr> <tr> <td>VM1745A0</td> <td>CARD SUPPORT</td> <td>3.000</td> <td>PC</td> </tr> </tbody> </table>  | Code                                 | Description | Qty | UOM | TM1001C3 | 15 SEC 120/240V BUZZER KIT              | 1.000 | PC | VI1220A1 | 4,2x12 TCB SELF-TAPPING SCREW     | 3.000 | PC | VI1850A0 | TCB M4x6 SCREW | 3.000 | PC | VM1745A0 | CARD SUPPORT       | 3.000 | PC |          |                               |       |    |
|           |   |   |            |   | Code  | Description                          | Qty         | UOM |     |          |   |       |    |          |                                   |       |    |          |                |       |    |          |                    |       |    |          |                               |       |    |
|           |   |   |            |   | TM1001C3  | 15 SEC 120/240V BUZZER KIT           | 1.000       | PC  |     |          |   |       |    |          |                                   |       |    |          |                |       |    |          |                    |       |    |          |                               |       |    |
|           |   |   |            |   | VI1220A1  | 4,2x12 TCB SELF-TAPPING SCREW        | 3.000       | PC  |     |          |   |       |    |          |                                   |       |    |          |                |       |    |          |                    |       |    |          |                               |       |    |
| VI1850A0  | TCB M4x6 SCREW                                | 3.000   | PC         |   |   |                                      |             |     |     |          |   |       |    |          |                                   |       |    |          |                |       |    |          |                    |       |    |          |                               |       |    |
| VM1745A0  | CARD SUPPORT                                  | 3.000   | PC         |   |   |                                      |             |     |     |          |   |       |    |          |                                   |       |    |          |                |       |    |          |                    |       |    |          |                               |       |    |
| TM1005A   | MI2 60 MIN 250V<br>16A TIMER                  |   | KTM1005A   | 60 MIN TIMER KIT                        | <table border="1"> <thead> <tr> <th>Code</th> <th>Description</th> <th>Qty</th> <th>UOM</th> </tr> </thead> <tbody> <tr> <td>TM1005A0</td> <td>MI2 60 MIN 250V 16A TIME</td> <td>1.000</td> <td>PC</td> </tr> <tr> <td>VI1850A0</td> <td>TCB M4x6 SCREW</td> <td>2.000</td> <td>PC</td> </tr> </tbody> </table>   | Code                                 | Description | Qty | UOM | TM1005A0 | MI2 60 MIN 250V 16A TIME                | 1.000 | PC | VI1850A0 | TCB M4x6 SCREW                    | 2.000 | PC |          |                |       |    |          |                    |       |    |          |                               |       |    |
|           |   |   |            |   | Code  | Description                          | Qty         | UOM |     |          |   |       |    |          |                                   |       |    |          |                |       |    |          |                    |       |    |          |                               |       |    |
| TM1005A0  | MI2 60 MIN 250V 16A TIME                      | 1.000   | PC         |   |   |                                      |             |     |     |          |   |       |    |          |                                   |       |    |          |                |       |    |          |                    |       |    |          |                               |       |    |
| VI1850A0  | TCB M4x6 SCREW                                | 2.000   | PC         |   |   |                                      |             |     |     |          |   |       |    |          |                                   |       |    |          |                |       |    |          |                    |       |    |          |                               |       |    |
| TR1100A   | 269°C 55.19052.80<br>ADJUSTABLE<br>THERMOSTAT |  | KTR1100A   | 269°C<br>THERMOSTAT KIT                 | <table border="1"> <thead> <tr> <th>Code</th> <th>Description</th> <th>Qty</th> <th>UOM</th> </tr> </thead> <tbody> <tr> <td>TR1100A0</td> <td>269°C 55.19052.80 ADJUSTABLE THERMOSTAT</td> <td>1.000</td> <td>PC</td> </tr> <tr> <td>VI1850A0</td> <td>TCB M4x6 SCREW</td> <td>2.000</td> <td>PC</td> </tr> </tbody> </table>  | Code                                 | Description | Qty | UOM | TR1100A0 | 269°C 55.19052.80 ADJUSTABLE THERMOSTAT | 1.000 | PC | VI1850A0 | TCB M4x6 SCREW                    | 2.000 | PC |          |                |       |    |          |                    |       |    |          |                               |       |    |
|           |   |   |            |   | Code  | Description                          | Qty         | UOM |     |          |   |       |    |          |                                   |       |    |          |                |       |    |          |                    |       |    |          |                               |       |    |
| TR1100A0  | 269°C 55.19052.80 ADJUSTABLE THERMOSTAT       | 1.000   | PC         |   |   |                                      |             |     |     |          |   |       |    |          |                                   |       |    |          |                |       |    |          |                    |       |    |          |                               |       |    |
| VI1850A0  | TCB M4x6 SCREW                                | 2.000   | PC         |   |   |                                      |             |     |     |          |   |       |    |          |                                   |       |    |          |                |       |    |          |                    |       |    |          |                               |       |    |
| VE1530A   | GOLD<br>THERMOMETER<br>BLUE LIGHT COVER       |  | KLP1012A   | GOLDEN<br>THERMOMETER<br>BLUE LIGHT KIT | <table border="1"> <thead> <tr> <th>Code</th> <th>Description</th> <th>Qty</th> <th>UOM</th> </tr> </thead> <tbody> <tr> <td>VE1170A0</td> <td>D16 OPAQUE NICKEL ELLIPTICAL SUPPORT</td> <td>1.000</td> <td>PC</td> </tr> <tr> <td>VE1530A0</td> <td>GOLD THERMOMETER BLUE LIGHT COVER</td> <td>1.000</td> <td>PC</td> </tr> <tr> <td>VE1535A1</td> <td>230V WHITE LED</td> <td>1.000</td> <td>PC</td> </tr> <tr> <td>VM1782A0</td> <td>INNER LAMP SUPPORT</td> <td>1.000</td> <td>PC</td> </tr> <tr> <td>VM2009A0</td> <td>D16 SILVER ELLIPTICAL SUPPORT</td> <td>1.000</td> <td>PC</td> </tr> </tbody> </table> | Code                                 | Description | Qty | UOM | VE1170A0 | D16 OPAQUE NICKEL ELLIPTICAL SUPPORT    | 1.000 | PC | VE1530A0 | GOLD THERMOMETER BLUE LIGHT COVER | 1.000 | PC | VE1535A1 | 230V WHITE LED | 1.000 | PC | VM1782A0 | INNER LAMP SUPPORT | 1.000 | PC | VM2009A0 | D16 SILVER ELLIPTICAL SUPPORT | 1.000 | PC |
|           |   |   |            |   | Code  | Description                          | Qty         | UOM |     |          |   |       |    |          |                                   |       |    |          |                |       |    |          |                    |       |    |          |                               |       |    |
|           |   |   |            |   | VE1170A0  | D16 OPAQUE NICKEL ELLIPTICAL SUPPORT | 1.000       | PC  |     |          |   |       |    |          |                                   |       |    |          |                |       |    |          |                    |       |    |          |                               |       |    |
|           |   |   |            |   | VE1530A0  | GOLD THERMOMETER BLUE LIGHT COVER    | 1.000       | PC  |     |          |   |       |    |          |                                   |       |    |          |                |       |    |          |                    |       |    |          |                               |       |    |
|           |   |   |            |   | VE1535A1  | 230V WHITE LED                       | 1.000       | PC  |     |          |   |       |    |          |                                   |       |    |          |                |       |    |          |                    |       |    |          |                               |       |    |
| VM1782A0  | INNER LAMP SUPPORT                            | 1.000   | PC         |   |   |                                      |             |     |     |          |   |       |    |          |                                   |       |    |          |                |       |    |          |                    |       |    |          |                               |       |    |
| VM2009A0  | D16 SILVER ELLIPTICAL SUPPORT                 | 1.000   | PC         |   |   |                                      |             |     |     |          |   |       |    |          |                                   |       |    |          |                |       |    |          |                    |       |    |          |                               |       |    |



| COMPONENT |                                      |  | SPARE PART |                                      |  |      |             |                                      |       |          |                                      |                |       |          |                |                    |       |          |                    |                                 |       |          |                                 |       |    |
|-----------|--------------------------------------|--|------------|--------------------------------------|--|------|-------------|--------------------------------------|-------|----------|--------------------------------------|----------------|-------|----------|----------------|--------------------|-------|----------|--------------------|---------------------------------|-------|----------|---------------------------------|-------|----|
| Code      | Description                          | Image  | Code       | Description                          | Kit components   |      |             |                                      |       |          |                                      |                |       |          |                |                    |       |          |                    |                                 |       |          |                                 |       |    |
| VE1535A   | 230V WHITE LED                       |   | KVE1535A   | 230V WHITE LED LIGHT 1 PC KIT        | <table border="1"> <thead> <tr> <th>Code</th> <th>Description</th> <th>Qty</th> <th>UOM</th> </tr> </thead> <tbody> <tr> <td>VE1535A1</td> <td>230V WHITE LED</td> <td>1.000</td> <td>PC</td> </tr> </tbody> </table>  | Code | Description | Qty                                  | UOM   | VE1535A1 | 230V WHITE LED                       | 1.000          | PC    |          |                |                    |       |          |                    |                                 |       |          |                                 |       |    |
|           |                                      |  | Code       | Description                          | Qty  | UOM  |             |                                      |       |          |                                      |                |       |          |                |                    |       |          |                    |                                 |       |          |                                 |       |    |
|           |                                      |  | VE1535A1   | 230V WHITE LED                       | 1.000  | PC   |             |                                      |       |          |                                      |                |       |          |                |                    |       |          |                    |                                 |       |          |                                 |       |    |
|           |                                      |  | KVE0105A   | CLOUD LED LIGHT+COVER+SUPPORT KIT    | <table border="1"> <thead> <tr> <th>Code</th> <th>Description</th> <th>Qty</th> <th>UOM</th> </tr> </thead> <tbody> <tr> <td>VE1170A0</td> <td>D16 OPAQUE NICKEL ELLIPTICAL SUPPORT</td> <td>1.000</td> <td>PC</td> </tr> <tr> <td>VE1535A1</td> <td>230V WHITE LED</td> <td>1.000</td> <td>PC</td> </tr> <tr> <td>VM1762A0</td> <td>INNER LAMP SUPPORT</td> <td>1.000</td> <td>PC</td> </tr> <tr> <td>VM1903A0</td> <td>GREEN PILOT WITH GOLD "CLOUD"</td> <td>1.000</td> <td>PC</td> </tr> </tbody> </table>   | Code | Description | Qty                                  | UOM   | VE1170A0 | D16 OPAQUE NICKEL ELLIPTICAL SUPPORT | 1.000          | PC    | VE1535A1 | 230V WHITE LED | 1.000              | PC    | VM1762A0 | INNER LAMP SUPPORT | 1.000                           | PC    | VM1903A0 | GREEN PILOT WITH GOLD "CLOUD"   | 1.000 | PC |
|           |                                      |  | Code       | Description                          | Qty  | UOM  |             |                                      |       |          |                                      |                |       |          |                |                    |       |          |                    |                                 |       |          |                                 |       |    |
|           |                                      |  | VE1170A0   | D16 OPAQUE NICKEL ELLIPTICAL SUPPORT | 1.000  | PC   |             |                                      |       |          |                                      |                |       |          |                |                    |       |          |                    |                                 |       |          |                                 |       |    |
|           |                                      |  | VE1535A1   | 230V WHITE LED                       | 1.000  | PC   |             |                                      |       |          |                                      |                |       |          |                |                    |       |          |                    |                                 |       |          |                                 |       |    |
|           |                                      |  | VM1762A0   | INNER LAMP SUPPORT                   | 1.000  | PC   |             |                                      |       |          |                                      |                |       |          |                |                    |       |          |                    |                                 |       |          |                                 |       |    |
|           |                                      |  | VM1903A0   | GREEN PILOT WITH GOLD "CLOUD"        | 1.000  | PC   |             |                                      |       |          |                                      |                |       |          |                |                    |       |          |                    |                                 |       |          |                                 |       |    |
|           |                                      |  | KVE0104A   | NEUTRAL GREEN LIGHT KIT              | <table border="1"> <thead> <tr> <th>Code</th> <th>Description</th> <th>Qty</th> <th>UOM</th> </tr> </thead> <tbody> <tr> <td>VE1170A0</td> <td>D16 OPAQUE NICKEL ELLIPTICAL SUPPORT</td> <td>1.000</td> <td>PC</td> </tr> <tr> <td>VE1535A1</td> <td>230V WHITE LED</td> <td>1.000</td> <td>PC</td> </tr> <tr> <td>VM1762A0</td> <td>INNER LAMP SUPPORT</td> <td>1.000</td> <td>PC</td> </tr> <tr> <td>VM1902A0</td> <td>NEUTRAL GREEN PLASTIC COVER FOR</td> <td>1.000</td> <td>PC</td> </tr> </tbody> </table> | Code | Description | Qty                                  | UOM   | VE1170A0 | D16 OPAQUE NICKEL ELLIPTICAL SUPPORT | 1.000          | PC    | VE1535A1 | 230V WHITE LED | 1.000              | PC    | VM1762A0 | INNER LAMP SUPPORT | 1.000                           | PC    | VM1902A0 | NEUTRAL GREEN PLASTIC COVER FOR | 1.000 | PC |
|           |                                      |  | Code       | Description                          | Qty  | UOM  |             |                                      |       |          |                                      |                |       |          |                |                    |       |          |                    |                                 |       |          |                                 |       |    |
|           |                                      |  | VE1170A0   | D16 OPAQUE NICKEL ELLIPTICAL SUPPORT | 1.000  | PC   |             |                                      |       |          |                                      |                |       |          |                |                    |       |          |                    |                                 |       |          |                                 |       |    |
| VE1535A1  | 230V WHITE LED                       | 1.000  | PC         |                                      |  |      |             |                                      |       |          |                                      |                |       |          |                |                    |       |          |                    |                                 |       |          |                                 |       |    |
| VM1762A0  | INNER LAMP SUPPORT                   | 1.000  | PC         |                                      |  |      |             |                                      |       |          |                                      |                |       |          |                |                    |       |          |                    |                                 |       |          |                                 |       |    |
| VM1902A0  | NEUTRAL GREEN PLASTIC COVER FOR      | 1.000  | PC         |                                      |  |      |             |                                      |       |          |                                      |                |       |          |                |                    |       |          |                    |                                 |       |          |                                 |       |    |
| KVE0102A  | GOLDEN FLAME LIGHT COVER KIT         | <table border="1"> <thead> <tr> <th>Code</th> <th>Description</th> <th>Qty</th> <th>UOM</th> </tr> </thead> <tbody> <tr> <td>VE1170A0</td> <td>D16 OPAQUE NICKEL ELLIPTICAL SUPPORT</td> <td>1.000</td> <td>PC</td> </tr> <tr> <td>VE1535A1</td> <td>230V WHITE LED</td> <td>1.000</td> <td>PC</td> </tr> <tr> <td>VM1762A0</td> <td>INNER LAMP SUPPORT</td> <td>1.000</td> <td>PC</td> </tr> <tr> <td>VM1767A0</td> <td>GREEN PILOT LIGHT W/ GOLD FLAME</td> <td>1.000</td> <td>PC</td> </tr> </tbody> </table> | Code       | Description                          | Qty  | UOM  | VE1170A0    | D16 OPAQUE NICKEL ELLIPTICAL SUPPORT | 1.000 | PC       | VE1535A1                             | 230V WHITE LED | 1.000 | PC       | VM1762A0       | INNER LAMP SUPPORT | 1.000 | PC       | VM1767A0           | GREEN PILOT LIGHT W/ GOLD FLAME | 1.000 | PC       |                                 |       |    |
| Code      | Description                          | Qty  | UOM        |                                      |  |      |             |                                      |       |          |                                      |                |       |          |                |                    |       |          |                    |                                 |       |          |                                 |       |    |
| VE1170A0  | D16 OPAQUE NICKEL ELLIPTICAL SUPPORT | 1.000  | PC         |                                      |  |      |             |                                      |       |          |                                      |                |       |          |                |                    |       |          |                    |                                 |       |          |                                 |       |    |
| VE1535A1  | 230V WHITE LED                       | 1.000  | PC         |                                      |  |      |             |                                      |       |          |                                      |                |       |          |                |                    |       |          |                    |                                 |       |          |                                 |       |    |
| VM1762A0  | INNER LAMP SUPPORT                   | 1.000  | PC         |                                      |  |      |             |                                      |       |          |                                      |                |       |          |                |                    |       |          |                    |                                 |       |          |                                 |       |    |
| VM1767A0  | GREEN PILOT LIGHT W/ GOLD FLAME      | 1.000  | PC         |                                      |  |      |             |                                      |       |          |                                      |                |       |          |                |                    |       |          |                    |                                 |       |          |                                 |       |    |
| KVE0101A  | SINUSOID LIGHT GREEN COVER KIT       | <table border="1"> <thead> <tr> <th>Code</th> <th>Description</th> <th>Qty</th> <th>UOM</th> </tr> </thead> <tbody> <tr> <td>VE1170A0</td> <td>D16 OPAQUE NICKEL ELLIPTICAL SUPPORT</td> <td>1.000</td> <td>PC</td> </tr> <tr> <td>VE1535A1</td> <td>230V WHITE LED</td> <td>1.000</td> <td>PC</td> </tr> <tr> <td>VM1762A0</td> <td>INNER LAMP SUPPORT</td> <td>1.000</td> <td>PC</td> </tr> <tr> <td>VM1765A0</td> <td>GREEN PILOT WITH GOLD SINUSOIDE</td> <td>1.000</td> <td>PC</td> </tr> </tbody> </table> | Code       | Description                          | Qty  | UOM  | VE1170A0    | D16 OPAQUE NICKEL ELLIPTICAL SUPPORT | 1.000 | PC       | VE1535A1                             | 230V WHITE LED | 1.000 | PC       | VM1762A0       | INNER LAMP SUPPORT | 1.000 | PC       | VM1765A0           | GREEN PILOT WITH GOLD SINUSOIDE | 1.000 | PC       |                                 |       |    |
| Code      | Description                          | Qty  | UOM        |                                      |  |      |             |                                      |       |          |                                      |                |       |          |                |                    |       |          |                    |                                 |       |          |                                 |       |    |
| VE1170A0  | D16 OPAQUE NICKEL ELLIPTICAL SUPPORT | 1.000  | PC         |                                      |  |      |             |                                      |       |          |                                      |                |       |          |                |                    |       |          |                    |                                 |       |          |                                 |       |    |
| VE1535A1  | 230V WHITE LED                       | 1.000  | PC         |                                      |  |      |             |                                      |       |          |                                      |                |       |          |                |                    |       |          |                    |                                 |       |          |                                 |       |    |
| VM1762A0  | INNER LAMP SUPPORT                   | 1.000  | PC         |                                      |  |      |             |                                      |       |          |                                      |                |       |          |                |                    |       |          |                    |                                 |       |          |                                 |       |    |
| VM1765A0  | GREEN PILOT WITH GOLD SINUSOIDE      | 1.000  | PC         |                                      |  |      |             |                                      |       |          |                                      |                |       |          |                |                    |       |          |                    |                                 |       |          |                                 |       |    |



| COMPONENT |   |   | SPARE PART |  |   |      |             |   |       |          |  |  |       |          |                   |  |       |          |                                    |                            |       |          |                       |                            |       |    |          |                                    |       |    |          |                       |       |    |          |                                    |       |    |
|-----------|---|---|------------|--|---|------|-------------|---|-------|----------|--|--|-------|----------|-------------------|--|-------|----------|------------------------------------|----------------------------|-------|----------|-----------------------|----------------------------|-------|----|----------|------------------------------------|-------|----|----------|-----------------------|-------|----|----------|------------------------------------|-------|----|
| Code      | Description                                   | Image   | Code       | Description                              | Kit components  |      |             |   |       |          |  |  |       |          |                   |  |       |          |                                    |                            |       |          |                       |                            |       |    |          |                                    |       |    |          |                       |       |    |          |                                    |       |    |
| VE1535A   | 230V WHITE LED                                |    | KVE0100A   | THERMOMETER<br>LIGHT COVER KIT           | <table border="1"> <thead> <tr> <th>Code</th> <th>Description</th> <th>Qty</th> <th>UOM</th> </tr> </thead> <tbody> <tr> <td>VE1530A0</td> <td>GOLD THERMOMETE<br/>R BLUE LIGHT<br/>COVER</td> <td>1.000</td> <td>PC</td> </tr> <tr> <td>VE1535A1</td> <td>230V WHITE<br/>LED</td> <td>1.000</td> <td>PC</td> </tr> <tr> <td>VM1761A0</td> <td>D16 BLACK<br/>ELLIPTICAL<br/>SUPPORT</td> <td>1.000</td> <td>PC</td> </tr> <tr> <td>VM1762A0</td> <td>INNER LAMP<br/>SUPPORT</td> <td>1.000</td> <td>PC</td> </tr> </tbody> </table> | Code | Description | Qty   | UOM   | VE1530A0 | GOLD THERMOMETE<br>R BLUE LIGHT<br>COVER | 1.000                                    | PC    | VE1535A1 | 230V WHITE<br>LED | 1.000                                    | PC    | VM1761A0 | D16 BLACK<br>ELLIPTICAL<br>SUPPORT | 1.000                      | PC    | VM1762A0 | INNER LAMP<br>SUPPORT | 1.000                      | PC    |    |          |                                    |       |    |          |                       |       |    |          |                                    |       |    |
|           |   |   | Code       | Description                              | Qty   | UOM  |             |   |       |          |  |  |       |          |                   |  |       |          |                                    |                            |       |          |                       |                            |       |    |          |                                    |       |    |          |                       |       |    |          |                                    |       |    |
|           |   |   | VE1530A0   | GOLD THERMOMETE<br>R BLUE LIGHT<br>COVER | 1.000   | PC   |             |   |       |          |  |  |       |          |                   |  |       |          |                                    |                            |       |          |                       |                            |       |    |          |                                    |       |    |          |                       |       |    |          |                                    |       |    |
| VE1535A1  | 230V WHITE<br>LED                             | 1.000   | PC         |  |   |      |             |   |       |          |  |  |       |          |                   |  |       |          |                                    |                            |       |          |                       |                            |       |    |          |                                    |       |    |          |                       |       |    |          |                                    |       |    |
| VM1761A0  | D16 BLACK<br>ELLIPTICAL<br>SUPPORT            | 1.000   | PC         |  |   |      |             |   |       |          |  |  |       |          |                   |  |       |          |                                    |                            |       |          |                       |                            |       |    |          |                                    |       |    |          |                       |       |    |          |                                    |       |    |
| VM1762A0  | INNER LAMP<br>SUPPORT                         | 1.000   | PC         |  |   |      |             |   |       |          |  |  |       |          |                   |  |       |          |                                    |                            |       |          |                       |                            |       |    |          |                                    |       |    |          |                       |       |    |          |                                    |       |    |
| KVE0011A  | SP KNOBS AND<br>LIGHTS KIT                    | <table border="1"> <thead> <tr> <th>Code</th> <th>Description</th> <th>Qty</th> <th>UOM</th> </tr> </thead> <tbody> <tr> <td>MN1105A0</td> <td>120-400C XP<br/>THERMOSTAT<br/>KNOB</td> <td>1.000</td> <td>PC</td> </tr> <tr> <td>MN1110A0</td> <td>XP NEUTRAL<br/>INDEX DIAL</td> <td>1.000</td> <td>PC</td> </tr> <tr> <td>VE1530A0</td> <td>GOLD THERMOMETE<br/>R BLUE LIGHT<br/>COVER</td> <td>1.000</td> <td>PC</td> </tr> <tr> <td>VE1535A1</td> <td>230V WHITE<br/>LED</td> <td>1.000</td> <td>PC</td> </tr> <tr> <td>VE1561A0</td> <td>NA/NA<br/>BIPOLAR<br/>SWITCH</td> <td>1.000</td> <td>PC</td> </tr> <tr> <td>VM1761A0</td> <td>D16 BLACK<br/>ELLIPTICAL<br/>SUPPORT</td> <td>2.000</td> <td>PC</td> </tr> <tr> <td>VM1762A0</td> <td>INNER LAMP<br/>SUPPORT</td> <td>1.000</td> <td>PC</td> </tr> <tr> <td>VM1776A0</td> <td>"GOLD "0-1"<br/>MATT SILVER<br/>KEY"</td> <td>1.000</td> <td>PC</td> </tr> </tbody> </table> | Code       | Description                              | Qty   | UOM  | MN1105A0    | 120-400C XP<br>THERMOSTAT<br>KNOB             | 1.000 | PC       | MN1110A0                                 | XP NEUTRAL<br>INDEX DIAL                 | 1.000 | PC       | VE1530A0          | GOLD THERMOMETE<br>R BLUE LIGHT<br>COVER | 1.000 | PC       | VE1535A1                           | 230V WHITE<br>LED          | 1.000 | PC       | VE1561A0              | NA/NA<br>BIPOLAR<br>SWITCH | 1.000 | PC | VM1761A0 | D16 BLACK<br>ELLIPTICAL<br>SUPPORT | 2.000 | PC | VM1762A0 | INNER LAMP<br>SUPPORT | 1.000 | PC | VM1776A0 | "GOLD "0-1"<br>MATT SILVER<br>KEY" | 1.000 | PC |
| Code      | Description                                   | Qty   | UOM        |  |   |      |             |   |       |          |  |  |       |          |                   |  |       |          |                                    |                            |       |          |                       |                            |       |    |          |                                    |       |    |          |                       |       |    |          |                                    |       |    |
| MN1105A0  | 120-400C XP<br>THERMOSTAT<br>KNOB             | 1.000   | PC         |  |   |      |             |   |       |          |  |  |       |          |                   |  |       |          |                                    |                            |       |          |                       |                            |       |    |          |                                    |       |    |          |                       |       |    |          |                                    |       |    |
| MN1110A0  | XP NEUTRAL<br>INDEX DIAL                      | 1.000   | PC         |  |   |      |             |   |       |          |  |  |       |          |                   |  |       |          |                                    |                            |       |          |                       |                            |       |    |          |                                    |       |    |          |                       |       |    |          |                                    |       |    |
| VE1530A0  | GOLD THERMOMETE<br>R BLUE LIGHT<br>COVER      | 1.000   | PC         |  |   |      |             |   |       |          |  |  |       |          |                   |  |       |          |                                    |                            |       |          |                       |                            |       |    |          |                                    |       |    |          |                       |       |    |          |                                    |       |    |
| VE1535A1  | 230V WHITE<br>LED                             | 1.000   | PC         |  |   |      |             |   |       |          |  |  |       |          |                   |  |       |          |                                    |                            |       |          |                       |                            |       |    |          |                                    |       |    |          |                       |       |    |          |                                    |       |    |
| VE1561A0  | NA/NA<br>BIPOLAR<br>SWITCH                    | 1.000   | PC         |  |   |      |             |   |       |          |  |  |       |          |                   |  |       |          |                                    |                            |       |          |                       |                            |       |    |          |                                    |       |    |          |                       |       |    |          |                                    |       |    |
| VM1761A0  | D16 BLACK<br>ELLIPTICAL<br>SUPPORT            | 2.000   | PC         |  |   |      |             |   |       |          |  |  |       |          |                   |  |       |          |                                    |                            |       |          |                       |                            |       |    |          |                                    |       |    |          |                       |       |    |          |                                    |       |    |
| VM1762A0  | INNER LAMP<br>SUPPORT                         | 1.000   | PC         |  |   |      |             |   |       |          |  |  |       |          |                   |  |       |          |                                    |                            |       |          |                       |                            |       |    |          |                                    |       |    |          |                       |       |    |          |                                    |       |    |
| VM1776A0  | "GOLD "0-1"<br>MATT SILVER<br>KEY"            | 1.000   | PC         |  |   |      |             |   |       |          |  |  |       |          |                   |  |       |          |                                    |                            |       |          |                       |                            |       |    |          |                                    |       |    |          |                       |       |    |          |                                    |       |    |
| KVE0008A  | XL PILOT BLUE<br>LIGHTS KIT                   | <table border="1"> <thead> <tr> <th>Code</th> <th>Description</th> <th>Qty</th> <th>UOM</th> </tr> </thead> <tbody> <tr> <td>VE1170A0</td> <td>D16 OPAQUE<br/>NICKEL<br/>ELLIPTICAL<br/>SUPPORT</td> <td>3.000</td> <td>PC</td> </tr> <tr> <td>VE1530A0</td> <td>GOLD THERMOMETE<br/>R BLUE LIGHT<br/>COVER</td> <td>1.000</td> <td>PC</td> </tr> <tr> <td>VE1535A1</td> <td>230V WHITE<br/>LED</td> <td>1.000</td> <td>PC</td> </tr> <tr> <td>VE1561A0</td> <td>NA/NA<br/>BIPOLAR<br/>SWITCH</td> <td>1.000</td> <td>PC</td> </tr> <tr> <td>VE1562A0</td> <td>UNIPOLAR NA<br/>PUSH BUTTO</td> <td>1.000</td> <td>PC</td> </tr> <tr> <td>VM1762A0</td> <td>INNER LAMP<br/>SUPPORT</td> <td>1.000</td> <td>PC</td> </tr> </tbody> </table>   | Code       | Description                              | Qty   | UOM  | VE1170A0    | D16 OPAQUE<br>NICKEL<br>ELLIPTICAL<br>SUPPORT | 3.000 | PC       | VE1530A0                                 | GOLD THERMOMETE<br>R BLUE LIGHT<br>COVER | 1.000 | PC       | VE1535A1          | 230V WHITE<br>LED                        | 1.000 | PC       | VE1561A0                           | NA/NA<br>BIPOLAR<br>SWITCH | 1.000 | PC       | VE1562A0              | UNIPOLAR NA<br>PUSH BUTTO  | 1.000 | PC | VM1762A0 | INNER LAMP<br>SUPPORT              | 1.000 | PC |          |                       |       |    |          |                                    |       |    |
| Code      | Description                                   | Qty   | UOM        |  |   |      |             |   |       |          |  |  |       |          |                   |  |       |          |                                    |                            |       |          |                       |                            |       |    |          |                                    |       |    |          |                       |       |    |          |                                    |       |    |
| VE1170A0  | D16 OPAQUE<br>NICKEL<br>ELLIPTICAL<br>SUPPORT | 3.000   | PC         |  |   |      |             |   |       |          |  |  |       |          |                   |  |       |          |                                    |                            |       |          |                       |                            |       |    |          |                                    |       |    |          |                       |       |    |          |                                    |       |    |
| VE1530A0  | GOLD THERMOMETE<br>R BLUE LIGHT<br>COVER      | 1.000   | PC         |  |   |      |             |   |       |          |  |  |       |          |                   |  |       |          |                                    |                            |       |          |                       |                            |       |    |          |                                    |       |    |          |                       |       |    |          |                                    |       |    |
| VE1535A1  | 230V WHITE<br>LED                             | 1.000   | PC         |  |   |      |             |   |       |          |  |  |       |          |                   |  |       |          |                                    |                            |       |          |                       |                            |       |    |          |                                    |       |    |          |                       |       |    |          |                                    |       |    |
| VE1561A0  | NA/NA<br>BIPOLAR<br>SWITCH                    | 1.000   | PC         |  |   |      |             |   |       |          |  |  |       |          |                   |  |       |          |                                    |                            |       |          |                       |                            |       |    |          |                                    |       |    |          |                       |       |    |          |                                    |       |    |
| VE1562A0  | UNIPOLAR NA<br>PUSH BUTTO                     | 1.000   | PC         |  |   |      |             |   |       |          |  |  |       |          |                   |  |       |          |                                    |                            |       |          |                       |                            |       |    |          |                                    |       |    |          |                       |       |    |          |                                    |       |    |
| VM1762A0  | INNER LAMP<br>SUPPORT                         | 1.000   | PC         |  |   |      |             |   |       |          |  |  |       |          |                   |  |       |          |                                    |                            |       |          |                       |                            |       |    |          |                                    |       |    |          |                       |       |    |          |                                    |       |    |



| COMPONENT |                                      |  | SPARE PART |                          |   |      |             |                                      |       |          |                                   |                                    |       |          |                               |                |       |    |          |                        |       |    |          |                                |       |    |          |                    |       |    |          |                                 |       |    |          |                                 |       |    |          |                                   |       |    |          |                                 |       |    |          |                               |       |    |          |                                      |   |      |             |     |     |          |                                      |       |    |          |                |       |    |          |                                |       |    |
|-----------|--------------------------------------|--|------------|--------------------------|---|------|-------------|--------------------------------------|-------|----------|-----------------------------------|------------------------------------|-------|----------|-------------------------------|----------------|-------|----|----------|------------------------|-------|----|----------|--------------------------------|-------|----|----------|--------------------|-------|----|----------|---------------------------------|-------|----|----------|---------------------------------|-------|----|----------|-----------------------------------|-------|----|----------|---------------------------------|-------|----|----------|-------------------------------|-------|----|----------|--------------------------------------|---|------|-------------|-----|-----|----------|--------------------------------------|-------|----|----------|----------------|-------|----|----------|--------------------------------|-------|----|
| Code      | Description                          | Image  | Code       | Description              | Kit components  |      |             |                                      |       |          |                                   |                                    |       |          |                               |                |       |    |          |                        |       |    |          |                                |       |    |          |                    |       |    |          |                                 |       |    |          |                                 |       |    |          |                                   |       |    |          |                                 |       |    |          |                               |       |    |          |                                      |   |      |             |     |     |          |                                      |       |    |          |                |       |    |          |                                |       |    |
| VE1535A   | 230V WHITE LED                       |   | KVE0008A   | XL PILOT BLUE LIGHTS KIT | <table border="1"> <thead> <tr> <th>Code</th> <th>Description</th> <th>Qty</th> <th>UOM</th> </tr> </thead> <tbody> <tr> <td>VM1775A0</td> <td>OPAQUE SILVER KEY WITH GOLD CLOUD</td> <td>1.000</td> <td>PC</td> </tr> <tr> <td>VM1776A0</td> <td>"GOLD "0-1"" MATT SILVER KEY"</td> <td>1.000</td> <td>PC</td> </tr> </tbody> </table> | Code | Description | Qty                                  | UOM   | VM1775A0 | OPAQUE SILVER KEY WITH GOLD CLOUD | 1.000                              | PC    | VM1776A0 | "GOLD "0-1"" MATT SILVER KEY" | 1.000          | PC    |    |          |                        |       |    |          |                                |       |    |          |                    |       |    |          |                                 |       |    |          |                                 |       |    |          |                                   |       |    |          |                                 |       |    |          |                               |       |    |          |                                      |   |      |             |     |     |          |                                      |       |    |          |                |       |    |          |                                |       |    |
|           |                                      |  | Code       | Description              | Qty   | UOM  |             |                                      |       |          |                                   |                                    |       |          |                               |                |       |    |          |                        |       |    |          |                                |       |    |          |                    |       |    |          |                                 |       |    |          |                                 |       |    |          |                                   |       |    |          |                                 |       |    |          |                               |       |    |          |                                      |   |      |             |     |     |          |                                      |       |    |          |                |       |    |          |                                |       |    |
| VM1775A0  | OPAQUE SILVER KEY WITH GOLD CLOUD    | 1.000  | PC         |                          |   |      |             |                                      |       |          |                                   |                                    |       |          |                               |                |       |    |          |                        |       |    |          |                                |       |    |          |                    |       |    |          |                                 |       |    |          |                                 |       |    |          |                                   |       |    |          |                                 |       |    |          |                               |       |    |          |                                      |   |      |             |     |     |          |                                      |       |    |          |                |       |    |          |                                |       |    |
| VM1776A0  | "GOLD "0-1"" MATT SILVER KEY"        | 1.000  | PC         |                          |   |      |             |                                      |       |          |                                   |                                    |       |          |                               |                |       |    |          |                        |       |    |          |                                |       |    |          |                    |       |    |          |                                 |       |    |          |                                 |       |    |          |                                   |       |    |          |                                 |       |    |          |                               |       |    |          |                                      |   |      |             |     |     |          |                                      |       |    |          |                |       |    |          |                                |       |    |
| KVE0007A  | XF-XG LED AND LED COVERS KIT         | <table border="1"> <thead> <tr> <th>Code</th> <th>Description</th> <th>Qty</th> <th>UOM</th> </tr> </thead> <tbody> <tr> <td>VE1170A0</td> <td>D16 OPAQUE NICKEL ELLIPTICAL SUPPORT</td> <td>5.000</td> <td>PC</td> </tr> <tr> <td>VE1530A0</td> <td>GOLD THERMOMETE R BLUE LIGHT COVER</td> <td>1.000</td> <td>PC</td> </tr> <tr> <td>VE1535A1</td> <td>230V WHITE LED</td> <td>1.000</td> <td>PC</td> </tr> <tr> <td>VE1562A0</td> <td>UNIPOLAR NA PUSH BUTTO</td> <td>1.000</td> <td>PC</td> </tr> <tr> <td>VE1585A0</td> <td>BLUE LIGHT COVER GOLD SINUSOID</td> <td>1.000</td> <td>PC</td> </tr> <tr> <td>VM1782A0</td> <td>INNER LAMP SUPPORT</td> <td>4.000</td> <td>PC</td> </tr> <tr> <td>VM1767A0</td> <td>GREEN PILOT LIGHT W/ GOLD FLAME</td> <td>1.000</td> <td>PC</td> </tr> <tr> <td>VM1774A0</td> <td>SILVER OPAQUE KEY W/ GOLD FLAME</td> <td>1.000</td> <td>PC</td> </tr> <tr> <td>VM1775A0</td> <td>OPAQUE SILVER KEY WITH GOLD CLOUD</td> <td>1.000</td> <td>PC</td> </tr> <tr> <td>VM1902A0</td> <td>NEUTRAL GREEN PLASTIC COVER FOR</td> <td>1.000</td> <td>PC</td> </tr> <tr> <td>VM1903A0</td> <td>GREEN PILOT WITH GOLD "CLOUD"</td> <td>1.000</td> <td>PC</td> </tr> </tbody> </table> | Code       | Description              | Qty   | UOM  | VE1170A0    | D16 OPAQUE NICKEL ELLIPTICAL SUPPORT | 5.000 | PC       | VE1530A0                          | GOLD THERMOMETE R BLUE LIGHT COVER | 1.000 | PC       | VE1535A1                      | 230V WHITE LED | 1.000 | PC | VE1562A0 | UNIPOLAR NA PUSH BUTTO | 1.000 | PC | VE1585A0 | BLUE LIGHT COVER GOLD SINUSOID | 1.000 | PC | VM1782A0 | INNER LAMP SUPPORT | 4.000 | PC | VM1767A0 | GREEN PILOT LIGHT W/ GOLD FLAME | 1.000 | PC | VM1774A0 | SILVER OPAQUE KEY W/ GOLD FLAME | 1.000 | PC | VM1775A0 | OPAQUE SILVER KEY WITH GOLD CLOUD | 1.000 | PC | VM1902A0 | NEUTRAL GREEN PLASTIC COVER FOR | 1.000 | PC | VM1903A0 | GREEN PILOT WITH GOLD "CLOUD" | 1.000 | PC | KLP1014A | SINUSOID LED LIGHT+COVER+SUPPORT KIT | <table border="1"> <thead> <tr> <th>Code</th> <th>Description</th> <th>Qty</th> <th>UOM</th> </tr> </thead> <tbody> <tr> <td>VE1170A0</td> <td>D16 OPAQUE NICKEL ELLIPTICAL SUPPORT</td> <td>2.000</td> <td>PC</td> </tr> <tr> <td>VE1535A1</td> <td>230V WHITE LED</td> <td>2.000</td> <td>PC</td> </tr> <tr> <td>VE1585A0</td> <td>BLUE LIGHT COVER GOLD SINUSOID</td> <td>2.000</td> <td>PC</td> </tr> </tbody> </table> | Code | Description | Qty | UOM | VE1170A0 | D16 OPAQUE NICKEL ELLIPTICAL SUPPORT | 2.000 | PC | VE1535A1 | 230V WHITE LED | 2.000 | PC | VE1585A0 | BLUE LIGHT COVER GOLD SINUSOID | 2.000 | PC |
| Code      | Description                          | Qty  | UOM        |                          |   |      |             |                                      |       |          |                                   |                                    |       |          |                               |                |       |    |          |                        |       |    |          |                                |       |    |          |                    |       |    |          |                                 |       |    |          |                                 |       |    |          |                                   |       |    |          |                                 |       |    |          |                               |       |    |          |                                      |   |      |             |     |     |          |                                      |       |    |          |                |       |    |          |                                |       |    |
| VE1170A0  | D16 OPAQUE NICKEL ELLIPTICAL SUPPORT | 5.000  | PC         |                          |   |      |             |                                      |       |          |                                   |                                    |       |          |                               |                |       |    |          |                        |       |    |          |                                |       |    |          |                    |       |    |          |                                 |       |    |          |                                 |       |    |          |                                   |       |    |          |                                 |       |    |          |                               |       |    |          |                                      |   |      |             |     |     |          |                                      |       |    |          |                |       |    |          |                                |       |    |
| VE1530A0  | GOLD THERMOMETE R BLUE LIGHT COVER   | 1.000  | PC         |                          |   |      |             |                                      |       |          |                                   |                                    |       |          |                               |                |       |    |          |                        |       |    |          |                                |       |    |          |                    |       |    |          |                                 |       |    |          |                                 |       |    |          |                                   |       |    |          |                                 |       |    |          |                               |       |    |          |                                      |   |      |             |     |     |          |                                      |       |    |          |                |       |    |          |                                |       |    |
| VE1535A1  | 230V WHITE LED                       | 1.000  | PC         |                          |   |      |             |                                      |       |          |                                   |                                    |       |          |                               |                |       |    |          |                        |       |    |          |                                |       |    |          |                    |       |    |          |                                 |       |    |          |                                 |       |    |          |                                   |       |    |          |                                 |       |    |          |                               |       |    |          |                                      |   |      |             |     |     |          |                                      |       |    |          |                |       |    |          |                                |       |    |
| VE1562A0  | UNIPOLAR NA PUSH BUTTO               | 1.000  | PC         |                          |   |      |             |                                      |       |          |                                   |                                    |       |          |                               |                |       |    |          |                        |       |    |          |                                |       |    |          |                    |       |    |          |                                 |       |    |          |                                 |       |    |          |                                   |       |    |          |                                 |       |    |          |                               |       |    |          |                                      |   |      |             |     |     |          |                                      |       |    |          |                |       |    |          |                                |       |    |
| VE1585A0  | BLUE LIGHT COVER GOLD SINUSOID       | 1.000  | PC         |                          |   |      |             |                                      |       |          |                                   |                                    |       |          |                               |                |       |    |          |                        |       |    |          |                                |       |    |          |                    |       |    |          |                                 |       |    |          |                                 |       |    |          |                                   |       |    |          |                                 |       |    |          |                               |       |    |          |                                      |   |      |             |     |     |          |                                      |       |    |          |                |       |    |          |                                |       |    |
| VM1782A0  | INNER LAMP SUPPORT                   | 4.000  | PC         |                          |   |      |             |                                      |       |          |                                   |                                    |       |          |                               |                |       |    |          |                        |       |    |          |                                |       |    |          |                    |       |    |          |                                 |       |    |          |                                 |       |    |          |                                   |       |    |          |                                 |       |    |          |                               |       |    |          |                                      |   |      |             |     |     |          |                                      |       |    |          |                |       |    |          |                                |       |    |
| VM1767A0  | GREEN PILOT LIGHT W/ GOLD FLAME      | 1.000  | PC         |                          |   |      |             |                                      |       |          |                                   |                                    |       |          |                               |                |       |    |          |                        |       |    |          |                                |       |    |          |                    |       |    |          |                                 |       |    |          |                                 |       |    |          |                                   |       |    |          |                                 |       |    |          |                               |       |    |          |                                      |   |      |             |     |     |          |                                      |       |    |          |                |       |    |          |                                |       |    |
| VM1774A0  | SILVER OPAQUE KEY W/ GOLD FLAME      | 1.000  | PC         |                          |   |      |             |                                      |       |          |                                   |                                    |       |          |                               |                |       |    |          |                        |       |    |          |                                |       |    |          |                    |       |    |          |                                 |       |    |          |                                 |       |    |          |                                   |       |    |          |                                 |       |    |          |                               |       |    |          |                                      |   |      |             |     |     |          |                                      |       |    |          |                |       |    |          |                                |       |    |
| VM1775A0  | OPAQUE SILVER KEY WITH GOLD CLOUD    | 1.000  | PC         |                          |   |      |             |                                      |       |          |                                   |                                    |       |          |                               |                |       |    |          |                        |       |    |          |                                |       |    |          |                    |       |    |          |                                 |       |    |          |                                 |       |    |          |                                   |       |    |          |                                 |       |    |          |                               |       |    |          |                                      |   |      |             |     |     |          |                                      |       |    |          |                |       |    |          |                                |       |    |
| VM1902A0  | NEUTRAL GREEN PLASTIC COVER FOR      | 1.000  | PC         |                          |   |      |             |                                      |       |          |                                   |                                    |       |          |                               |                |       |    |          |                        |       |    |          |                                |       |    |          |                    |       |    |          |                                 |       |    |          |                                 |       |    |          |                                   |       |    |          |                                 |       |    |          |                               |       |    |          |                                      |   |      |             |     |     |          |                                      |       |    |          |                |       |    |          |                                |       |    |
| VM1903A0  | GREEN PILOT WITH GOLD "CLOUD"        | 1.000  | PC         |                          |   |      |             |                                      |       |          |                                   |                                    |       |          |                               |                |       |    |          |                        |       |    |          |                                |       |    |          |                    |       |    |          |                                 |       |    |          |                                 |       |    |          |                                   |       |    |          |                                 |       |    |          |                               |       |    |          |                                      |   |      |             |     |     |          |                                      |       |    |          |                |       |    |          |                                |       |    |
| Code      | Description                          | Qty  | UOM        |                          |   |      |             |                                      |       |          |                                   |                                    |       |          |                               |                |       |    |          |                        |       |    |          |                                |       |    |          |                    |       |    |          |                                 |       |    |          |                                 |       |    |          |                                   |       |    |          |                                 |       |    |          |                               |       |    |          |                                      |   |      |             |     |     |          |                                      |       |    |          |                |       |    |          |                                |       |    |
| VE1170A0  | D16 OPAQUE NICKEL ELLIPTICAL SUPPORT | 2.000  | PC         |                          |   |      |             |                                      |       |          |                                   |                                    |       |          |                               |                |       |    |          |                        |       |    |          |                                |       |    |          |                    |       |    |          |                                 |       |    |          |                                 |       |    |          |                                   |       |    |          |                                 |       |    |          |                               |       |    |          |                                      |   |      |             |     |     |          |                                      |       |    |          |                |       |    |          |                                |       |    |
| VE1535A1  | 230V WHITE LED                       | 2.000  | PC         |                          |   |      |             |                                      |       |          |                                   |                                    |       |          |                               |                |       |    |          |                        |       |    |          |                                |       |    |          |                    |       |    |          |                                 |       |    |          |                                 |       |    |          |                                   |       |    |          |                                 |       |    |          |                               |       |    |          |                                      |   |      |             |     |     |          |                                      |       |    |          |                |       |    |          |                                |       |    |
| VE1585A0  | BLUE LIGHT COVER GOLD SINUSOID       | 2.000  | PC         |                          |   |      |             |                                      |       |          |                                   |                                    |       |          |                               |                |       |    |          |                        |       |    |          |                                |       |    |          |                    |       |    |          |                                 |       |    |          |                                 |       |    |          |                                   |       |    |          |                                 |       |    |          |                               |       |    |          |                                      |   |      |             |     |     |          |                                      |       |    |          |                |       |    |          |                                |       |    |



| COMPONENT |                                      |  | SPARE PART           |  |   |                                   |  |                     |             |                     |                                      |                |                                      |                |                               |          |                                    |          |                    |          |                |          |                                  |          |                    |       |    |          |                               |       |    |
|-----------|--------------------------------------|--|----------------------|--|---|-----------------------------------|--|---------------------|-------------|---------------------|--------------------------------------|----------------|--------------------------------------|----------------|-------------------------------|----------|------------------------------------|----------|--------------------|----------|----------------|----------|----------------------------------|----------|--------------------|-------|----|----------|-------------------------------|-------|----|
| Code      | Description                          | Image  | Code                 | Description  | Kit components  |                                   |  |                     |             |                     |                                      |                |                                      |                |                               |          |                                    |          |                    |          |                |          |                                  |          |                    |       |    |          |                               |       |    |
| VE1535A   | 230V WHITE LED                       |   | KLP1014A             | SINUSOID LED LIGHT+COVER+SUPPORT KIT   | <table border="1"> <thead> <tr> <th>Code</th> <th>Description</th> <th>Qty</th> <th>UOM</th> </tr> </thead> <tbody> <tr> <td>VM1782A0</td> <td>INNER LAMP SUPPORT</td> <td>2.000</td> <td>PC</td> </tr> <tr> <td>VM2009A0</td> <td>D16 SILVER ELLIPTICAL SUPPORT</td> <td>1.000</td> <td>PC</td> </tr> </tbody> </table>  | Code                              | Description  | Qty                 | UOM         | VM1782A0            | INNER LAMP SUPPORT                   | 2.000          | PC                                   | VM2009A0       | D16 SILVER ELLIPTICAL SUPPORT | 1.000    | PC                                 |          |                    |          |                |          |                                  |          |                    |       |    |          |                               |       |    |
|           |                                      |  |                      |  | Code  | Description                       | Qty  | UOM                 |             |                     |                                      |                |                                      |                |                               |          |                                    |          |                    |          |                |          |                                  |          |                    |       |    |          |                               |       |    |
|           |                                      |  |                      |  | VM1782A0  | INNER LAMP SUPPORT                | 2.000  | PC                  |             |                     |                                      |                |                                      |                |                               |          |                                    |          |                    |          |                |          |                                  |          |                    |       |    |          |                               |       |    |
|           |                                      |  |                      |  | VM2009A0  | D16 SILVER ELLIPTICAL SUPPORT     | 1.000  | PC                  |             |                     |                                      |                |                                      |                |                               |          |                                    |          |                    |          |                |          |                                  |          |                    |       |    |          |                               |       |    |
|           |                                      |  |                      |  | KLP1012A  | GOLDEN THERMOMETER BLUE LIGHT KIT | <table border="1"> <thead> <tr> <th>Code</th> <th>Description</th> <th>Qty</th> <th>UOM</th> </tr> </thead> <tbody> <tr> <td>VE1170A0</td> <td>D16 OPAQUE NICKEL ELLIPTICAL SUPPORT</td> <td>1.000</td> <td>PC</td> </tr> <tr> <td>VE1530A0</td> <td>GOLD THERMOMETE R BLUE LIGHT COVER</td> <td>1.000</td> <td>PC</td> </tr> <tr> <td>VE1535A1</td> <td>230V WHITE LED</td> <td>1.000</td> <td>PC</td> </tr> <tr> <td>VM1782A0</td> <td>INNER LAMP SUPPORT</td> <td>1.000</td> <td>PC</td> </tr> <tr> <td>VM2009A0</td> <td>D16 SILVER ELLIPTICAL SUPPORT</td> <td>1.000</td> <td>PC</td> </tr> </tbody> </table> | Code                | Description | Qty                 | UOM                                  | VE1170A0       | D16 OPAQUE NICKEL ELLIPTICAL SUPPORT | 1.000          | PC                            | VE1530A0 | GOLD THERMOMETE R BLUE LIGHT COVER | 1.000    | PC                 | VE1535A1 | 230V WHITE LED | 1.000    | PC                               | VM1782A0 | INNER LAMP SUPPORT | 1.000 | PC | VM2009A0 | D16 SILVER ELLIPTICAL SUPPORT | 1.000 | PC |
|           |                                      |  |                      |  |   |                                   | Code   | Description         | Qty         | UOM                 |                                      |                |                                      |                |                               |          |                                    |          |                    |          |                |          |                                  |          |                    |       |    |          |                               |       |    |
|           |                                      |  | VE1170A0             | D16 OPAQUE NICKEL ELLIPTICAL SUPPORT   |   |                                   | 1.000  | PC                  |             |                     |                                      |                |                                      |                |                               |          |                                    |          |                    |          |                |          |                                  |          |                    |       |    |          |                               |       |    |
|           |                                      |  | VE1530A0             | GOLD THERMOMETE R BLUE LIGHT COVER   |   |                                   | 1.000  | PC                  |             |                     |                                      |                |                                      |                |                               |          |                                    |          |                    |          |                |          |                                  |          |                    |       |    |          |                               |       |    |
|           |                                      |  | VE1535A1             | 230V WHITE LED   |   |                                   | 1.000  | PC                  |             |                     |                                      |                |                                      |                |                               |          |                                    |          |                    |          |                |          |                                  |          |                    |       |    |          |                               |       |    |
|           |                                      |  | VM1782A0             | INNER LAMP SUPPORT   |   |                                   | 1.000  | PC                  |             |                     |                                      |                |                                      |                |                               |          |                                    |          |                    |          |                |          |                                  |          |                    |       |    |          |                               |       |    |
|           |                                      |  | VM2009A0             | D16 SILVER ELLIPTICAL SUPPORT  | 1.000   | PC                                |  |                     |             |                     |                                      |                |                                      |                |                               |          |                                    |          |                    |          |                |          |                                  |          |                    |       |    |          |                               |       |    |
|           |                                      |  | KLP1010A             | THERMOSTAT GREEN LIGHT KIT   | <table border="1"> <thead> <tr> <th>Code</th> <th>Description</th> <th>Qty</th> <th>UOM</th> </tr> </thead> <tbody> <tr> <td>VE1170A0</td> <td>D16 OPAQUE NICKEL ELLIPTICAL SUPPORT</td> <td>1.000</td> <td>PC</td> </tr> <tr> <td>VE1535A1</td> <td>230V WHITE LED</td> <td>1.000</td> <td>PC</td> </tr> <tr> <td>VM1782A0</td> <td>INNER LAMP SUPPORT</td> <td>1.000</td> <td>PC</td> </tr> <tr> <td>VM1784A0</td> <td>GREEN PILOT WITH GOLD THERMOMETE</td> <td>1.000</td> <td>PC</td> </tr> </tbody> </table> | Code                              | Description  | Qty                 | UOM         | VE1170A0            | D16 OPAQUE NICKEL ELLIPTICAL SUPPORT | 1.000          | PC                                   | VE1535A1       | 230V WHITE LED                | 1.000    | PC                                 | VM1782A0 | INNER LAMP SUPPORT | 1.000    | PC             | VM1784A0 | GREEN PILOT WITH GOLD THERMOMETE | 1.000    | PC                 |       |    |          |                               |       |    |
| Code      | Description                          | Qty  |                      |  | UOM   |                                   |  |                     |             |                     |                                      |                |                                      |                |                               |          |                                    |          |                    |          |                |          |                                  |          |                    |       |    |          |                               |       |    |
| VE1170A0  | D16 OPAQUE NICKEL ELLIPTICAL SUPPORT | 1.000  |                      |  | PC  |                                   |  |                     |             |                     |                                      |                |                                      |                |                               |          |                                    |          |                    |          |                |          |                                  |          |                    |       |    |          |                               |       |    |
| VE1535A1  | 230V WHITE LED                       | 1.000  |                      |  | PC  |                                   |  |                     |             |                     |                                      |                |                                      |                |                               |          |                                    |          |                    |          |                |          |                                  |          |                    |       |    |          |                               |       |    |
| VM1782A0  | INNER LAMP SUPPORT                   | 1.000  |                      |  | PC  |                                   |  |                     |             |                     |                                      |                |                                      |                |                               |          |                                    |          |                    |          |                |          |                                  |          |                    |       |    |          |                               |       |    |
| VM1784A0  | GREEN PILOT WITH GOLD THERMOMETE     | 1.000  |                      |  | PC  |                                   |  |                     |             |                     |                                      |                |                                      |                |                               |          |                                    |          |                    |          |                |          |                                  |          |                    |       |    |          |                               |       |    |
| KVE1556A  | ENERGY REGULATOR KIT                 | <table border="1"> <thead> <tr> <th>Code</th> <th>Description</th> <th>Qty</th> <th>UOM</th> </tr> </thead> <tbody> <tr> <td>VE1556A0</td> <td>THERMAL SWITCH 240V</td> <td>1.000</td> <td>PC</td> </tr> <tr> <td>VI1850A0</td> <td>TCB M4x6 SCREW</td> <td>2.000</td> <td>PC</td> </tr> </tbody> </table> | Code                 | Description  | Qty   | UOM                               | VE1556A0   | THERMAL SWITCH 240V | 1.000       | PC                  | VI1850A0                             | TCB M4x6 SCREW | 2.000                                | PC             |                               |          |                                    |          |                    |          |                |          |                                  |          |                    |       |    |          |                               |       |    |
|           |                                      | Code   | Description          | Qty  | UOM   |                                   |  |                     |             |                     |                                      |                |                                      |                |                               |          |                                    |          |                    |          |                |          |                                  |          |                    |       |    |          |                               |       |    |
|           |                                      | VE1556A0   | THERMAL SWITCH 240V  | 1.000  | PC  |                                   |  |                     |             |                     |                                      |                |                                      |                |                               |          |                                    |          |                    |          |                |          |                                  |          |                    |       |    |          |                               |       |    |
|           |                                      | VI1850A0   | TCB M4x6 SCREW       | 2.000  | PC  |                                   |  |                     |             |                     |                                      |                |                                      |                |                               |          |                                    |          |                    |          |                |          |                                  |          |                    |       |    |          |                               |       |    |
|           |                                      | KVE1556A   | ENERGY REGULATOR KIT | <table border="1"> <thead> <tr> <th>Code</th> <th>Description</th> <th>Qty</th> <th>UOM</th> </tr> </thead> <tbody> <tr> <td>VE1556A0</td> <td>THERMAL SWITCH 240V</td> <td>1.000</td> <td>PC</td> </tr> <tr> <td>VI1850A0</td> <td>TCB M4x6 SCREW</td> <td>2.000</td> <td>PC</td> </tr> </tbody> </table> | Code  | Description                       | Qty  | UOM                 | VE1556A0    | THERMAL SWITCH 240V | 1.000                                | PC             | VI1850A0                             | TCB M4x6 SCREW | 2.000                         | PC       |                                    |          |                    |          |                |          |                                  |          |                    |       |    |          |                               |       |    |
|           |                                      |  |                      | Code   | Description   | Qty                               | UOM  |                     |             |                     |                                      |                |                                      |                |                               |          |                                    |          |                    |          |                |          |                                  |          |                    |       |    |          |                               |       |    |
| VE1556A0  | THERMAL SWITCH 240V                  |  |                      | 1.000  | PC  |                                   |  |                     |             |                     |                                      |                |                                      |                |                               |          |                                    |          |                    |          |                |          |                                  |          |                    |       |    |          |                               |       |    |
| VI1850A0  | TCB M4x6 SCREW                       |  |                      | 2.000  | PC  |                                   |  |                     |             |                     |                                      |                |                                      |                |                               |          |                                    |          |                    |          |                |          |                                  |          |                    |       |    |          |                               |       |    |
| KVE1556A  | ENERGY REGULATOR KIT                 |  |                      | <table border="1"> <thead> <tr> <th>Code</th> <th>Description</th> <th>Qty</th> <th>UOM</th> </tr> </thead> <tbody> <tr> <td>VE1556A0</td> <td>THERMAL SWITCH 240V</td> <td>1.000</td> <td>PC</td> </tr> <tr> <td>VI1850A0</td> <td>TCB M4x6 SCREW</td> <td>2.000</td> <td>PC</td> </tr> </tbody> </table> | Code  | Description                       | Qty  | UOM                 | VE1556A0    | THERMAL SWITCH 240V | 1.000                                | PC             | VI1850A0                             | TCB M4x6 SCREW | 2.000                         | PC       |                                    |          |                    |          |                |          |                                  |          |                    |       |    |          |                               |       |    |
|           |                                      |  |                      | Code   | Description   | Qty                               | UOM  |                     |             |                     |                                      |                |                                      |                |                               |          |                                    |          |                    |          |                |          |                                  |          |                    |       |    |          |                               |       |    |
|           |                                      | VE1556A0   | THERMAL SWITCH 240V  | 1.000  | PC  |                                   |  |                     |             |                     |                                      |                |                                      |                |                               |          |                                    |          |                    |          |                |          |                                  |          |                    |       |    |          |                               |       |    |
|           |                                      | VI1850A0   | TCB M4x6 SCREW       | 2.000  | PC  |                                   |  |                     |             |                     |                                      |                |                                      |                |                               |          |                                    |          |                    |          |                |          |                                  |          |                    |       |    |          |                               |       |    |
|           |                                      | KVE1556A   | ENERGY REGULATOR KIT | <table border="1"> <thead> <tr> <th>Code</th> <th>Description</th> <th>Qty</th> <th>UOM</th> </tr> </thead> <tbody> <tr> <td>VE1556A0</td> <td>THERMAL SWITCH 240V</td> <td>1.000</td> <td>PC</td> </tr> <tr> <td>VI1850A0</td> <td>TCB M4x6 SCREW</td> <td>2.000</td> <td>PC</td> </tr> </tbody> </table> | Code  | Description                       | Qty  | UOM                 | VE1556A0    | THERMAL SWITCH 240V | 1.000                                | PC             | VI1850A0                             | TCB M4x6 SCREW | 2.000                         | PC       |                                    |          |                    |          |                |          |                                  |          |                    |       |    |          |                               |       |    |
|           |                                      |  |                      | Code   | Description   | Qty                               | UOM  |                     |             |                     |                                      |                |                                      |                |                               |          |                                    |          |                    |          |                |          |                                  |          |                    |       |    |          |                               |       |    |
| VE1556A0  | THERMAL SWITCH 240V                  |  |                      | 1.000  | PC  |                                   |  |                     |             |                     |                                      |                |                                      |                |                               |          |                                    |          |                    |          |                |          |                                  |          |                    |       |    |          |                               |       |    |
| VI1850A0  | TCB M4x6 SCREW                       |  |                      | 2.000  | PC  |                                   |  |                     |             |                     |                                      |                |                                      |                |                               |          |                                    |          |                    |          |                |          |                                  |          |                    |       |    |          |                               |       |    |
| KVE1556A  | ENERGY REGULATOR KIT                 |  |                      | <table border="1"> <thead> <tr> <th>Code</th> <th>Description</th> <th>Qty</th> <th>UOM</th> </tr> </thead> <tbody> <tr> <td>VE1556A0</td> <td>THERMAL SWITCH 240V</td> <td>1.000</td> <td>PC</td> </tr> <tr> <td>VI1850A0</td> <td>TCB M4x6 SCREW</td> <td>2.000</td> <td>PC</td> </tr> </tbody> </table> | Code  | Description                       | Qty  | UOM                 | VE1556A0    | THERMAL SWITCH 240V | 1.000                                | PC             | VI1850A0                             | TCB M4x6 SCREW | 2.000                         | PC       |                                    |          |                    |          |                |          |                                  |          |                    |       |    |          |                               |       |    |
|           |                                      |  |                      | Code   | Description   | Qty                               | UOM  |                     |             |                     |                                      |                |                                      |                |                               |          |                                    |          |                    |          |                |          |                                  |          |                    |       |    |          |                               |       |    |
|           |                                      | VE1556A0   | THERMAL SWITCH 240V  | 1.000  | PC  |                                   |  |                     |             |                     |                                      |                |                                      |                |                               |          |                                    |          |                    |          |                |          |                                  |          |                    |       |    |          |                               |       |    |
|           |                                      | VI1850A0   | TCB M4x6 SCREW       | 2.000  | PC  |                                   |  |                     |             |                     |                                      |                |                                      |                |                               |          |                                    |          |                    |          |                |          |                                  |          |                    |       |    |          |                               |       |    |
|           |                                      | KVE1556A   | ENERGY REGULATOR KIT | <table border="1"> <thead> <tr> <th>Code</th> <th>Description</th> <th>Qty</th> <th>UOM</th> </tr> </thead> <tbody> <tr> <td>VE1556A0</td> <td>THERMAL SWITCH 240V</td> <td>1.000</td> <td>PC</td> </tr> <tr> <td>VI1850A0</td> <td>TCB M4x6 SCREW</td> <td>2.000</td> <td>PC</td> </tr> </tbody> </table> | Code  | Description                       | Qty  | UOM                 | VE1556A0    | THERMAL SWITCH 240V | 1.000                                | PC             | VI1850A0                             | TCB M4x6 SCREW | 2.000                         | PC       |                                    |          |                    |          |                |          |                                  |          |                    |       |    |          |                               |       |    |
|           |                                      |  |                      | Code   | Description   | Qty                               | UOM  |                     |             |                     |                                      |                |                                      |                |                               |          |                                    |          |                    |          |                |          |                                  |          |                    |       |    |          |                               |       |    |
| VE1556A0  | THERMAL SWITCH 240V                  |  |                      | 1.000  | PC  |                                   |  |                     |             |                     |                                      |                |                                      |                |                               |          |                                    |          |                    |          |                |          |                                  |          |                    |       |    |          |                               |       |    |
| VI1850A0  | TCB M4x6 SCREW                       |  |                      | 2.000  | PC  |                                   |  |                     |             |                     |                                      |                |                                      |                |                               |          |                                    |          |                    |          |                |          |                                  |          |                    |       |    |          |                               |       |    |
| KVE1556A  | ENERGY REGULATOR KIT                 |  |                      | <table border="1"> <thead> <tr> <th>Code</th> <th>Description</th> <th>Qty</th> <th>UOM</th> </tr> </thead> <tbody> <tr> <td>VE1556A0</td> <td>THERMAL SWITCH 240V</td> <td>1.000</td> <td>PC</td> </tr> <tr> <td>VI1850A0</td> <td>TCB M4x6 SCREW</td> <td>2.000</td> <td>PC</td> </tr> </tbody> </table> | Code  | Description                       | Qty  | UOM                 | VE1556A0    | THERMAL SWITCH 240V | 1.000                                | PC             | VI1850A0                             | TCB M4x6 SCREW | 2.000                         | PC       |                                    |          |                    |          |                |          |                                  |          |                    |       |    |          |                               |       |    |
|           |                                      |  |                      | Code   | Description   | Qty                               | UOM  |                     |             |                     |                                      |                |                                      |                |                               |          |                                    |          |                    |          |                |          |                                  |          |                    |       |    |          |                               |       |    |
|           |                                      | VE1556A0   | THERMAL SWITCH 240V  | 1.000  | PC  |                                   |  |                     |             |                     |                                      |                |                                      |                |                               |          |                                    |          |                    |          |                |          |                                  |          |                    |       |    |          |                               |       |    |
|           |                                      | VI1850A0   | TCB M4x6 SCREW       | 2.000  | PC  |                                   |  |                     |             |                     |                                      |                |                                      |                |                               |          |                                    |          |                    |          |                |          |                                  |          |                    |       |    |          |                               |       |    |
|           |                                      | KVE1556A   | ENERGY REGULATOR KIT | <table border="1"> <thead> <tr> <th>Code</th> <th>Description</th> <th>Qty</th> <th>UOM</th> </tr> </thead> <tbody> <tr> <td>VE1556A0</td> <td>THERMAL SWITCH 240V</td> <td>1.000</td> <td>PC</td> </tr> <tr> <td>VI1850A0</td> <td>TCB M4x6 SCREW</td> <td>2.000</td> <td>PC</td> </tr> </tbody> </table> | Code  | Description                       | Qty  | UOM                 | VE1556A0    | THERMAL SWITCH 240V | 1.000                                | PC             | VI1850A0                             | TCB M4x6 SCREW | 2.000                         | PC       |                                    |          |                    |          |                |          |                                  |          |                    |       |    |          |                               |       |    |
|           |                                      |  |                      | Code   | Description   | Qty                               | UOM  |                     |             |                     |                                      |                |                                      |                |                               |          |                                    |          |                    |          |                |          |                                  |          |                    |       |    |          |                               |       |    |
| VE1556A0  | THERMAL SWITCH 240V                  |  |                      | 1.000  | PC  |                                   |  |                     |             |                     |                                      |                |                                      |                |                               |          |                                    |          |                    |          |                |          |                                  |          |                    |       |    |          |                               |       |    |
| VI1850A0  | TCB M4x6 SCREW                       |  |                      | 2.000  | PC  |                                   |  |                     |             |                     |                                      |                |                                      |                |                               |          |                                    |          |                    |          |                |          |                                  |          |                    |       |    |          |                               |       |    |
| KVE1556A  | ENERGY REGULATOR KIT                 |  |                      | <table border="1"> <thead> <tr> <th>Code</th> <th>Description</th> <th>Qty</th> <th>UOM</th> </tr> </thead> <tbody> <tr> <td>VE1556A0</td> <td>THERMAL SWITCH 240V</td> <td>1.000</td> <td>PC</td> </tr> <tr> <td>VI1850A0</td> <td>TCB M4x6 SCREW</td> <td>2.000</td> <td>PC</td> </tr> </tbody> </table> | Code  | Description                       | Qty  | UOM                 | VE1556A0    | THERMAL SWITCH 240V | 1.000                                | PC             | VI1850A0                             | TCB M4x6 SCREW | 2.000                         | PC       |                                    |          |                    |          |                |          |                                  |          |                    |       |    |          |                               |       |    |
|           |                                      |  |                      | Code   | Description   | Qty                               | UOM  |                     |             |                     |                                      |                |                                      |                |                               |          |                                    |          |                    |          |                |          |                                  |          |                    |       |    |          |                               |       |    |
|           |                                      | VE1556A0   | THERMAL SWITCH 240V  | 1.000  | PC  |                                   |  |                     |             |                     |                                      |                |                                      |                |                               |          |                                    |          |                    |          |                |          |                                  |          |                    |       |    |          |                               |       |    |
|           |                                      | VI1850A0   | TCB M4x6 SCREW       | 2.000  | PC  |                                   |  |                     |             |                     |                                      |                |                                      |                |                               |          |                                    |          |                    |          |                |          |                                  |          |                    |       |    |          |                               |       |    |



| COMPONENT |  |   | SPARE PART |   |   |  |             |     |     |          |   |       |    |          |                   |       |    |          |                                      |       |    |          |                                      |       |    |          |                                     |       |    |          |  |       |    |          |                               |       |    |          |                                     |       |    |
|-----------|--|---|------------|---|---|--|-------------|-----|-----|----------|---|-------|----|----------|-------------------|-------|----|----------|--------------------------------------|-------|----|----------|--------------------------------------|-------|----|----------|-------------------------------------|-------|----|----------|--|-------|----|----------|-------------------------------|-------|----|----------|-------------------------------------|-------|----|
| Code      | Description                                  | Image   | Code       | Description                                 | Kit components  |  |             |     |     |          |   |       |    |          |                   |       |    |          |                                      |       |    |          |                                      |       |    |          |                                     |       |    |          |  |       |    |          |                               |       |    |          |                                     |       |    |
| VE1585A   | BLUE LIGHT COVER<br>GOLD SINUSOID            |    | KLP1014A   | SINUSOID LED<br>LIGHT+COVER+SUP<br>PORT KIT | <table border="1"> <thead> <tr> <th>Code</th> <th>Description</th> <th>Qty</th> <th>UOM</th> </tr> </thead> <tbody> <tr> <td>VE1170A0</td> <td>D16 OPAQUE<br/>NICKEL<br/>ELLIPTICAL<br/>SUPPORT</td> <td>2.000</td> <td>PC</td> </tr> <tr> <td>VE1535A1</td> <td>230V WHITE<br/>LED</td> <td>2.000</td> <td>PC</td> </tr> <tr> <td>VE1585A0</td> <td>BLUE LIGHT<br/>COVER GOLD<br/>SINUSOID</td> <td>2.000</td> <td>PC</td> </tr> <tr> <td>VM1762A0</td> <td>INNER LAMP<br/>SUPPORT</td> <td>2.000</td> <td>PC</td> </tr> <tr> <td>VM2009A0</td> <td>D16 SILVER<br/>ELLIPTICAL<br/>SUPPORT</td> <td>1.000</td> <td>PC</td> </tr> </tbody> </table>  | Code   | Description | Qty | UOM | VE1170A0 | D16 OPAQUE<br>NICKEL<br>ELLIPTICAL<br>SUPPORT | 2.000 | PC | VE1535A1 | 230V WHITE<br>LED | 2.000 | PC | VE1585A0 | BLUE LIGHT<br>COVER GOLD<br>SINUSOID | 2.000 | PC | VM1762A0 | INNER LAMP<br>SUPPORT                | 2.000 | PC | VM2009A0 | D16 SILVER<br>ELLIPTICAL<br>SUPPORT | 1.000 | PC |          |  |       |    |          |                               |       |    |          |                                     |       |    |
|           |  |   |            |   | Code  | Description  | Qty         | UOM |     |          |   |       |    |          |                   |       |    |          |                                      |       |    |          |                                      |       |    |          |                                     |       |    |          |  |       |    |          |                               |       |    |          |                                     |       |    |
|           |  |   |            |   | VE1170A0  | D16 OPAQUE<br>NICKEL<br>ELLIPTICAL<br>SUPPORT      | 2.000       | PC  |     |          |   |       |    |          |                   |       |    |          |                                      |       |    |          |                                      |       |    |          |                                     |       |    |          |  |       |    |          |                               |       |    |          |                                     |       |    |
|           |  |   |            |   | VE1535A1  | 230V WHITE<br>LED                                  | 2.000       | PC  |     |          |   |       |    |          |                   |       |    |          |                                      |       |    |          |                                      |       |    |          |                                     |       |    |          |  |       |    |          |                               |       |    |          |                                     |       |    |
|           |  |   |            |   | VE1585A0  | BLUE LIGHT<br>COVER GOLD<br>SINUSOID               | 2.000       | PC  |     |          |   |       |    |          |                   |       |    |          |                                      |       |    |          |                                      |       |    |          |                                     |       |    |          |  |       |    |          |                               |       |    |          |                                     |       |    |
| VM1762A0  | INNER LAMP<br>SUPPORT                        | 2.000   | PC         |   |   |  |             |     |     |          |   |       |    |          |                   |       |    |          |                                      |       |    |          |                                      |       |    |          |                                     |       |    |          |  |       |    |          |                               |       |    |          |                                     |       |    |
| VM2009A0  | D16 SILVER<br>ELLIPTICAL<br>SUPPORT          | 1.000   | PC         |   |   |  |             |     |     |          |   |       |    |          |                   |       |    |          |                                      |       |    |          |                                      |       |    |          |                                     |       |    |          |  |       |    |          |                               |       |    |          |                                     |       |    |
| VM1762A   | INNER LAMP<br>SUPPORT                        |   | KVM1762A   | LAMP INTERNAL<br>SUPPORT KIT                | <table border="1"> <thead> <tr> <th>Code</th> <th>Description</th> <th>Qty</th> <th>UOM</th> </tr> </thead> <tbody> <tr> <td>VM1762A0</td> <td>INNER LAMP<br/>SUPPORT</td> <td>1.000</td> <td>PC</td> </tr> </tbody> </table>   | Code   | Description | Qty | UOM | VM1762A0 | INNER LAMP<br>SUPPORT                         | 1.000 | PC |          |                   |       |    |          |                                      |       |    |          |                                      |       |    |          |                                     |       |    |          |  |       |    |          |                               |       |    |          |                                     |       |    |
|           |  |   |            |   | Code  | Description  | Qty         | UOM |     |          |   |       |    |          |                   |       |    |          |                                      |       |    |          |                                      |       |    |          |                                     |       |    |          |  |       |    |          |                               |       |    |          |                                     |       |    |
| VM1762A0  | INNER LAMP<br>SUPPORT                        | 1.000   | PC         |   |   |  |             |     |     |          |   |       |    |          |                   |       |    |          |                                      |       |    |          |                                      |       |    |          |                                     |       |    |          |  |       |    |          |                               |       |    |          |                                     |       |    |
| VM1972A   | BAKERLUX/CHEFLU<br>X MANUAL<br>CONTROL PANEL |  | KVM1972A   | CL/BL MANUAL<br>CONTROL BOARD<br>KIT        | <table border="1"> <thead> <tr> <th>Code</th> <th>Description</th> <th>Qty</th> <th>UOM</th> </tr> </thead> <tbody> <tr> <td>VE1530A0</td> <td>GOLD<br/>THERMOMETE<br/>R BLUE LIGHT<br/>COVER</td> <td>1.000</td> <td>PC</td> </tr> <tr> <td>VE1535A1</td> <td>230V WHITE<br/>LED</td> <td>2.000</td> <td>PC</td> </tr> <tr> <td>VE1561A0</td> <td>NA/NA<br/>BIPOLAR<br/>SWITCH</td> <td>1.000</td> <td>PC</td> </tr> <tr> <td>VE1585A0</td> <td>BLUE LIGHT<br/>COVER GOLD<br/>SINUSOID</td> <td>1.000</td> <td>PC</td> </tr> <tr> <td>VM1762A0</td> <td>INNER LAMP<br/>SUPPORT</td> <td>2.000</td> <td>PC</td> </tr> <tr> <td>VM1972A0</td> <td>BAKERLUX/CH<br/>EFLUX<br/>MANUAL<br/>CONTROL<br/>PANEL</td> <td>1.000</td> <td>PC</td> </tr> <tr> <td>VM2007A0</td> <td>FAN SPEED<br/>SILVER<br/>BUTTON</td> <td>1.000</td> <td>PC</td> </tr> <tr> <td>VM2009A0</td> <td>D16 SILVER<br/>ELLIPTICAL<br/>SUPPORT</td> <td>3.000</td> <td>PC</td> </tr> </tbody> </table> | Code   | Description | Qty | UOM | VE1530A0 | GOLD<br>THERMOMETE<br>R BLUE LIGHT<br>COVER   | 1.000 | PC | VE1535A1 | 230V WHITE<br>LED | 2.000 | PC | VE1561A0 | NA/NA<br>BIPOLAR<br>SWITCH           | 1.000 | PC | VE1585A0 | BLUE LIGHT<br>COVER GOLD<br>SINUSOID | 1.000 | PC | VM1762A0 | INNER LAMP<br>SUPPORT               | 2.000 | PC | VM1972A0 | BAKERLUX/CH<br>EFLUX<br>MANUAL<br>CONTROL<br>PANEL | 1.000 | PC | VM2007A0 | FAN SPEED<br>SILVER<br>BUTTON | 1.000 | PC | VM2009A0 | D16 SILVER<br>ELLIPTICAL<br>SUPPORT | 3.000 | PC |
|           |  |   |            |   | Code  | Description  | Qty         | UOM |     |          |   |       |    |          |                   |       |    |          |                                      |       |    |          |                                      |       |    |          |                                     |       |    |          |  |       |    |          |                               |       |    |          |                                     |       |    |
|           |  |   |            |   | VE1530A0  | GOLD<br>THERMOMETE<br>R BLUE LIGHT<br>COVER        | 1.000       | PC  |     |          |   |       |    |          |                   |       |    |          |                                      |       |    |          |                                      |       |    |          |                                     |       |    |          |  |       |    |          |                               |       |    |          |                                     |       |    |
|           |  |   |            |   | VE1535A1  | 230V WHITE<br>LED                                  | 2.000       | PC  |     |          |   |       |    |          |                   |       |    |          |                                      |       |    |          |                                      |       |    |          |                                     |       |    |          |  |       |    |          |                               |       |    |          |                                     |       |    |
|           |  |   |            |   | VE1561A0  | NA/NA<br>BIPOLAR<br>SWITCH                         | 1.000       | PC  |     |          |   |       |    |          |                   |       |    |          |                                      |       |    |          |                                      |       |    |          |                                     |       |    |          |  |       |    |          |                               |       |    |          |                                     |       |    |
|           |  |   |            |   | VE1585A0  | BLUE LIGHT<br>COVER GOLD<br>SINUSOID               | 1.000       | PC  |     |          |   |       |    |          |                   |       |    |          |                                      |       |    |          |                                      |       |    |          |                                     |       |    |          |  |       |    |          |                               |       |    |          |                                     |       |    |
|           |  |   |            |   | VM1762A0  | INNER LAMP<br>SUPPORT                              | 2.000       | PC  |     |          |   |       |    |          |                   |       |    |          |                                      |       |    |          |                                      |       |    |          |                                     |       |    |          |  |       |    |          |                               |       |    |          |                                     |       |    |
|           |  |   |            |   | VM1972A0  | BAKERLUX/CH<br>EFLUX<br>MANUAL<br>CONTROL<br>PANEL | 1.000       | PC  |     |          |   |       |    |          |                   |       |    |          |                                      |       |    |          |                                      |       |    |          |                                     |       |    |          |  |       |    |          |                               |       |    |          |                                     |       |    |
|           |  |   |            |   | VM2007A0  | FAN SPEED<br>SILVER<br>BUTTON                      | 1.000       | PC  |     |          |   |       |    |          |                   |       |    |          |                                      |       |    |          |                                      |       |    |          |                                     |       |    |          |  |       |    |          |                               |       |    |          |                                     |       |    |
| VM2009A0  | D16 SILVER<br>ELLIPTICAL<br>SUPPORT          | 3.000   | PC         |   |   |  |             |     |     |          |   |       |    |          |                   |       |    |          |                                      |       |    |          |                                      |       |    |          |                                     |       |    |          |  |       |    |          |                               |       |    |          |                                     |       |    |

| COMPONENT |   |   | SPARE PART |   |   |      |             |     |     |          |                                      |       |    |          |                                 |       |    |          |                                      |       |    |          |                               |       |    |
|-----------|---|---|------------|---|---|------|-------------|-----|-----|----------|--------------------------------------|-------|----|----------|---------------------------------|-------|----|----------|--------------------------------------|-------|----|----------|-------------------------------|-------|----|
| Code      | Description                             | Image   | Code       | Description                             | Kit components  |      |             |     |     |          |                                      |       |    |          |                                 |       |    |          |                                      |       |    |          |                               |       |    |
| VM2007A   | FAN SPEED SILVER BUTTON                 |    | KVM2007A   | FAN SPEED BUTTON KIT                    | <table border="1"> <thead> <tr> <th>Code</th> <th>Description</th> <th>Qty</th> <th>UOM</th> </tr> </thead> <tbody> <tr> <td>VM2007A0</td> <td>FAN SPEED SILVER BUTTON</td> <td>1.000</td> <td>PC</td> </tr> </tbody> </table>  | Code | Description | Qty | UOM | VM2007A0 | FAN SPEED SILVER BUTTON              | 1.000 | PC |          |                                 |       |    |          |                                      |       |    |          |                               |       |    |
| Code      | Description                             | Qty   | UOM        |   |   |      |             |     |     |          |                                      |       |    |          |                                 |       |    |          |                                      |       |    |          |                               |       |    |
| VM2007A0  | FAN SPEED SILVER BUTTON                 | 1.000   | PC         |   |   |      |             |     |     |          |                                      |       |    |          |                                 |       |    |          |                                      |       |    |          |                               |       |    |
| VM2009A   | D16 SILVER ELLIPTICAL SUPPORT           |    | KVM2009A   | D16 SILVER ELLIPTICAL SUPPORT KIT       | <table border="1"> <thead> <tr> <th>Code</th> <th>Description</th> <th>Qty</th> <th>UOM</th> </tr> </thead> <tbody> <tr> <td>VM2009A0</td> <td>D16 SILVER ELLIPTICAL SUPPORT</td> <td>1.000</td> <td>PC</td> </tr> </tbody> </table>  | Code | Description | Qty | UOM | VM2009A0 | D16 SILVER ELLIPTICAL SUPPORT        | 1.000 | PC |          |                                 |       |    |          |                                      |       |    |          |                               |       |    |
| Code      | Description                             | Qty   | UOM        |   |   |      |             |     |     |          |                                      |       |    |          |                                 |       |    |          |                                      |       |    |          |                               |       |    |
| VM2009A0  | D16 SILVER ELLIPTICAL SUPPORT           | 1.000   | PC         |   |   |      |             |     |     |          |                                      |       |    |          |                                 |       |    |          |                                      |       |    |          |                               |       |    |
|           |   |   | KVM1019B   | MANUAL PROVER CONTROL BOARD KIT         | <table border="1"> <thead> <tr> <th>Code</th> <th>Description</th> <th>Qty</th> <th>UOM</th> </tr> </thead> <tbody> <tr> <td>MS1018B0</td> <td>MANUAL PROOFER CONTROL BOARD STICKER</td> <td>1.000</td> <td>PC</td> </tr> <tr> <td>MS1018C0</td> <td>MANUAL PROVER FRONT COVER (° C)</td> <td>1.000</td> <td>PC</td> </tr> <tr> <td>VM1019B0</td> <td>MANUAL PROOVER PLASTIC CONTROL PANEL</td> <td>1.000</td> <td>PC</td> </tr> <tr> <td>VM2009A0</td> <td>D16 SILVER ELLIPTICAL SUPPORT</td> <td>3.000</td> <td>PC</td> </tr> </tbody> </table> | Code | Description | Qty | UOM | MS1018B0 | MANUAL PROOFER CONTROL BOARD STICKER | 1.000 | PC | MS1018C0 | MANUAL PROVER FRONT COVER (° C) | 1.000 | PC | VM1019B0 | MANUAL PROOVER PLASTIC CONTROL PANEL | 1.000 | PC | VM2009A0 | D16 SILVER ELLIPTICAL SUPPORT | 3.000 | PC |
| Code      | Description                             | Qty   | UOM        |   |   |      |             |     |     |          |                                      |       |    |          |                                 |       |    |          |                                      |       |    |          |                               |       |    |
| MS1018B0  | MANUAL PROOFER CONTROL BOARD STICKER    | 1.000   | PC         |   |   |      |             |     |     |          |                                      |       |    |          |                                 |       |    |          |                                      |       |    |          |                               |       |    |
| MS1018C0  | MANUAL PROVER FRONT COVER (° C)         | 1.000   | PC         |   |   |      |             |     |     |          |                                      |       |    |          |                                 |       |    |          |                                      |       |    |          |                               |       |    |
| VM1019B0  | MANUAL PROOVER PLASTIC CONTROL PANEL    | 1.000   | PC         |   |   |      |             |     |     |          |                                      |       |    |          |                                 |       |    |          |                                      |       |    |          |                               |       |    |
| VM2009A0  | D16 SILVER ELLIPTICAL SUPPORT           | 3.000   | PC         |   |   |      |             |     |     |          |                                      |       |    |          |                                 |       |    |          |                                      |       |    |          |                               |       |    |
| VE1295A   | MK 16A 230V DOOR MICROSWITCH            |  | KVE1295A   | 16A 230V DOOR MICROSWITCH KIT           | <table border="1"> <thead> <tr> <th>Code</th> <th>Description</th> <th>Qty</th> <th>UOM</th> </tr> </thead> <tbody> <tr> <td>VE1295A0</td> <td>MK 16A 230V DOOR MICROSWITC</td> <td>1.000</td> <td>PC</td> </tr> </tbody> </table>  | Code | Description | Qty | UOM | VE1295A0 | MK 16A 230V DOOR MICROSWITC          | 1.000 | PC |          |                                 |       |    |          |                                      |       |    |          |                               |       |    |
| Code      | Description                             | Qty   | UOM        |   |   |      |             |     |     |          |                                      |       |    |          |                                 |       |    |          |                                      |       |    |          |                               |       |    |
| VE1295A0  | MK 16A 230V DOOR MICROSWITC             | 1.000   | PC         |   |   |      |             |     |     |          |                                      |       |    |          |                                 |       |    |          |                                      |       |    |          |                               |       |    |
| VM1200A   | DOOR MECHANIC MICROSWITCH SUPPORT PLATE |  | VM1200A0   | DOOR MECHANIC MICROSWITCH SUPPORT PLATE |   |      |             |     |     |          |                                      |       |    |          |                                 |       |    |          |                                      |       |    |          |                               |       |    |



| COMPONENT  |                                    |   | SPARE PART |                                      |   |                                    |             |     |          |                                 |                                    |       |          |                        |                           |       |    |          |                                 |       |    |
|--|------------------------------------|---|------------|--------------------------------------|---|------------------------------------|-------------|-----|----------|---------------------------------|------------------------------------|-------|----------|------------------------|---------------------------|-------|----|----------|---------------------------------|-------|----|
| Code   | Description                        | Image   | Code       | Description                          | Kit components  |                                    |             |     |          |                                 |                                    |       |          |                        |                           |       |    |          |                                 |       |    |
| VM1555A  | CT BT COOLING FAN SUPPORT          |    | KVN1165A   | S.5E ADVANCE/MM 230V COOLING FAN KIT | <table border="1"> <thead> <tr> <th>Code</th> <th>Description</th> <th>Qty</th> <th>UOM</th> </tr> </thead> <tbody> <tr> <td>VI1099A0</td> <td>SELF-DRILLIN G SCREW 4.8X13 TCB+ Z</td> <td>4.000</td> <td>PC</td> </tr> <tr> <td>VM1555A2</td> <td>CT BT COOLING FAN SUPPORT</td> <td>1.000</td> <td>PC</td> </tr> <tr> <td>VN1165A0</td> <td>230Vac 50/60Hz COOLING DOWN FAN</td> <td>1.000</td> <td>PC</td> </tr> </tbody> </table> | Code                               | Description | Qty | UOM      | VI1099A0                        | SELF-DRILLIN G SCREW 4.8X13 TCB+ Z | 4.000 | PC       | VM1555A2               | CT BT COOLING FAN SUPPORT | 1.000 | PC | VN1165A0 | 230Vac 50/60Hz COOLING DOWN FAN | 1.000 | PC |
|  |                                    |   |            |                                      | Code  | Description                        | Qty         | UOM |          |                                 |                                    |       |          |                        |                           |       |    |          |                                 |       |    |
| VI1099A0   | SELF-DRILLIN G SCREW 4.8X13 TCB+ Z | 4.000   | PC         |                                      |   |                                    |             |     |          |                                 |                                    |       |          |                        |                           |       |    |          |                                 |       |    |
| VM1555A2   | CT BT COOLING FAN SUPPORT          | 1.000   | PC         |                                      |   |                                    |             |     |          |                                 |                                    |       |          |                        |                           |       |    |          |                                 |       |    |
| VN1165A0   | 230Vac 50/60Hz COOLING DOWN FAN    | 1.000   | PC         |                                      |   |                                    |             |     |          |                                 |                                    |       |          |                        |                           |       |    |          |                                 |       |    |
| <table border="1"> <thead> <tr> <th>Code</th> <th>Description</th> <th>Qty</th> <th>UOM</th> </tr> </thead> <tbody> <tr> <td>VI1099A0</td> <td>SELF-DRILLIN G SCREW 4.8X13 TCB+ Z</td> <td>4.000</td> <td>PC</td> </tr> <tr> <td>VM1555A2</td> <td>CT BT COOLING FAN SUPPORT</td> <td>1.000</td> <td>PC</td> </tr> <tr> <td>VN1164A0</td> <td>12VDC COOLING DONW FAN</td> <td>1.000</td> <td>PC</td> </tr> </tbody> </table> | Code                               | Description   | Qty        | UOM                                  | VI1099A0  | SELF-DRILLIN G SCREW 4.8X13 TCB+ Z | 4.000       | PC  | VM1555A2 | CT BT COOLING FAN SUPPORT       | 1.000                              | PC    | VN1164A0 | 12VDC COOLING DONW FAN | 1.000                     | PC    |    |          |                                 |       |    |
| Code   | Description                        | Qty   | UOM        |                                      |   |                                    |             |     |          |                                 |                                    |       |          |                        |                           |       |    |          |                                 |       |    |
| VI1099A0   | SELF-DRILLIN G SCREW 4.8X13 TCB+ Z | 4.000   | PC         |                                      |   |                                    |             |     |          |                                 |                                    |       |          |                        |                           |       |    |          |                                 |       |    |
| VM1555A2   | CT BT COOLING FAN SUPPORT          | 1.000   | PC         |                                      |   |                                    |             |     |          |                                 |                                    |       |          |                        |                           |       |    |          |                                 |       |    |
| VN1164A0   | 12VDC COOLING DONW FAN             | 1.000   | PC         |                                      |   |                                    |             |     |          |                                 |                                    |       |          |                        |                           |       |    |          |                                 |       |    |
| VM1556A  | XBC-XVC COOLING FAN GUARD          |  | KVM1556A   | XBC-XVC COOLING FAN GUARD KIT        | <table border="1"> <thead> <tr> <th>Code</th> <th>Description</th> <th>Qty</th> <th>UOM</th> </tr> </thead> <tbody> <tr> <td>VM1556A0</td> <td>XBC-XVC COOLING FAN GUARD</td> <td>1.000</td> <td>PC</td> </tr> </tbody> </table>  | Code                               | Description | Qty | UOM      | VM1556A0                        | XBC-XVC COOLING FAN GUARD          | 1.000 | PC       |                        |                           |       |    |          |                                 |       |    |
|  |                                    |   |            |                                      | Code  | Description                        | Qty         | UOM |          |                                 |                                    |       |          |                        |                           |       |    |          |                                 |       |    |
| VM1556A0   | XBC-XVC COOLING FAN GUARD          | 1.000   | PC         |                                      |   |                                    |             |     |          |                                 |                                    |       |          |                        |                           |       |    |          |                                 |       |    |
| <table border="1"> <thead> <tr> <th>Code</th> <th>Description</th> <th>Qty</th> <th>UOM</th> </tr> </thead> <tbody> <tr> <td>VM1556A0</td> <td>XBC-XVC COOLING FAN GUARD</td> <td>1.000</td> <td>PC</td> </tr> </tbody> </table>   | Code                               | Description   | Qty        | UOM                                  | VM1556A0  | XBC-XVC COOLING FAN GUARD          | 1.000       | PC  |          |                                 |                                    |       |          |                        |                           |       |    |          |                                 |       |    |
| Code   | Description                        | Qty   | UOM        |                                      |   |                                    |             |     |          |                                 |                                    |       |          |                        |                           |       |    |          |                                 |       |    |
| VM1556A0   | XBC-XVC COOLING FAN GUARD          | 1.000   | PC         |                                      |   |                                    |             |     |          |                                 |                                    |       |          |                        |                           |       |    |          |                                 |       |    |
| VN1165A  | 230Vac 50/60Hz COOLING DOWN FA     |  | KVN1165A   | S.5E ADVANCE/MM 230V COOLING FAN KIT | <table border="1"> <thead> <tr> <th>Code</th> <th>Description</th> <th>Qty</th> <th>UOM</th> </tr> </thead> <tbody> <tr> <td>VI1099A0</td> <td>SELF-DRILLIN G SCREW 4.8X13 TCB+ Z</td> <td>4.000</td> <td>PC</td> </tr> <tr> <td>VM1555A2</td> <td>CT BT COOLING FAN SUPPORT</td> <td>1.000</td> <td>PC</td> </tr> <tr> <td>VN1165A0</td> <td>230Vac 50/60Hz COOLING DOWN FAN</td> <td>1.000</td> <td>PC</td> </tr> </tbody> </table> | Code                               | Description | Qty | UOM      | VI1099A0                        | SELF-DRILLIN G SCREW 4.8X13 TCB+ Z | 4.000 | PC       | VM1555A2               | CT BT COOLING FAN SUPPORT | 1.000 | PC | VN1165A0 | 230Vac 50/60Hz COOLING DOWN FAN | 1.000 | PC |
|  |                                    |   |            |                                      | Code  | Description                        | Qty         | UOM |          |                                 |                                    |       |          |                        |                           |       |    |          |                                 |       |    |
| VI1099A0   | SELF-DRILLIN G SCREW 4.8X13 TCB+ Z | 4.000   | PC         |                                      |   |                                    |             |     |          |                                 |                                    |       |          |                        |                           |       |    |          |                                 |       |    |
| VM1555A2   | CT BT COOLING FAN SUPPORT          | 1.000   | PC         |                                      |   |                                    |             |     |          |                                 |                                    |       |          |                        |                           |       |    |          |                                 |       |    |
| VN1165A0   | 230Vac 50/60Hz COOLING DOWN FAN    | 1.000   | PC         |                                      |   |                                    |             |     |          |                                 |                                    |       |          |                        |                           |       |    |          |                                 |       |    |
| <table border="1"> <thead> <tr> <th>Code</th> <th>Description</th> <th>Qty</th> <th>UOM</th> </tr> </thead> <tbody> <tr> <td>VM1555A2</td> <td>CT BT COOLING FAN SUPPORT</td> <td>1.000</td> <td>PC</td> </tr> <tr> <td>VN1165A0</td> <td>230Vac 50/60Hz COOLING DOWN FAN</td> <td>1.000</td> <td>PC</td> </tr> </tbody> </table>  | Code                               | Description   | Qty        | UOM                                  | VM1555A2  | CT BT COOLING FAN SUPPORT          | 1.000       | PC  | VN1165A0 | 230Vac 50/60Hz COOLING DOWN FAN | 1.000                              | PC    |          |                        |                           |       |    |          |                                 |       |    |
| Code   | Description                        | Qty   | UOM        |                                      |   |                                    |             |     |          |                                 |                                    |       |          |                        |                           |       |    |          |                                 |       |    |
| VM1555A2   | CT BT COOLING FAN SUPPORT          | 1.000   | PC         |                                      |   |                                    |             |     |          |                                 |                                    |       |          |                        |                           |       |    |          |                                 |       |    |
| VN1165A0   | 230Vac 50/60Hz COOLING DOWN FAN    | 1.000   | PC         |                                      |   |                                    |             |     |          |                                 |                                    |       |          |                        |                           |       |    |          |                                 |       |    |
| VL1026A  | BEND FOR DRAIN PIPE                |  | KVL1026A   | DRAIN PIPE BEND KI                   | <table border="1"> <thead> <tr> <th>Code</th> <th>Description</th> <th>Qty</th> <th>UOM</th> </tr> </thead> <tbody> <tr> <td>GN1400A0</td> <td>U-TRAP SEAL</td> <td>1.000</td> <td>PC</td> </tr> <tr> <td>VL1026A0</td> <td>BEND FOR DRAIN PIPE</td> <td>1.000</td> <td>PC</td> </tr> <tr> <td>VM2039A0</td> <td>DRAIN BEND FIXING RING</td> <td>1.000</td> <td>PC</td> </tr> </tbody> </table>                                       | Code                               | Description | Qty | UOM      | GN1400A0                        | U-TRAP SEAL                        | 1.000 | PC       | VL1026A0               | BEND FOR DRAIN PIPE       | 1.000 | PC | VM2039A0 | DRAIN BEND FIXING RING          | 1.000 | PC |
|  |                                    |   |            |                                      | Code  | Description                        | Qty         | UOM |          |                                 |                                    |       |          |                        |                           |       |    |          |                                 |       |    |
|  |                                    |   |            |                                      | GN1400A0  | U-TRAP SEAL                        | 1.000       | PC  |          |                                 |                                    |       |          |                        |                           |       |    |          |                                 |       |    |
| VL1026A0   | BEND FOR DRAIN PIPE                | 1.000   | PC         |                                      |   |                                    |             |     |          |                                 |                                    |       |          |                        |                           |       |    |          |                                 |       |    |
| VM2039A0   | DRAIN BEND FIXING RING             | 1.000   | PC         |                                      |   |                                    |             |     |          |                                 |                                    |       |          |                        |                           |       |    |          |                                 |       |    |
| <table border="1"> <thead> <tr> <th>Code</th> <th>Description</th> <th>Qty</th> <th>UOM</th> </tr> </thead> <tbody> <tr> <td>GN1400A0</td> <td>U-TRAP SEAL</td> <td>1.000</td> <td>PC</td> </tr> <tr> <td>VL1026A0</td> <td>BEND FOR DRAIN PIPE</td> <td>1.000</td> <td>PC</td> </tr> </tbody> </table>  | Code                               | Description   | Qty        | UOM                                  | GN1400A0  | U-TRAP SEAL                        | 1.000       | PC  | VL1026A0 | BEND FOR DRAIN PIPE             | 1.000                              | PC    |          |                        |                           |       |    |          |                                 |       |    |
| Code   | Description                        | Qty   | UOM        |                                      |   |                                    |             |     |          |                                 |                                    |       |          |                        |                           |       |    |          |                                 |       |    |
| GN1400A0   | U-TRAP SEAL                        | 1.000   | PC         |                                      |   |                                    |             |     |          |                                 |                                    |       |          |                        |                           |       |    |          |                                 |       |    |
| VL1026A0   | BEND FOR DRAIN PIPE                | 1.000   | PC         |                                      |   |                                    |             |     |          |                                 |                                    |       |          |                        |                           |       |    |          |                                 |       |    |
| <table border="1"> <thead> <tr> <th>Code</th> <th>Description</th> <th>Qty</th> <th>UOM</th> </tr> </thead> <tbody> <tr> <td>VM2039A0</td> <td>DRAIN BEND FIXING RING</td> <td>1.000</td> <td>PC</td> </tr> </tbody> </table>  | Code                               | Description   | Qty        | UOM                                  | VM2039A0  | DRAIN BEND FIXING RING             | 1.000       | PC  |          |                                 |                                    |       |          |                        |                           |       |    |          |                                 |       |    |
| Code   | Description                        | Qty   | UOM        |                                      |   |                                    |             |     |          |                                 |                                    |       |          |                        |                           |       |    |          |                                 |       |    |
| VM2039A0   | DRAIN BEND FIXING RING             | 1.000   | PC         |                                      |   |                                    |             |     |          |                                 |                                    |       |          |                        |                           |       |    |          |                                 |       |    |





| COMPONENT |   |   | SPARE PART |  |  |      |             |     |     |          |  |       |    |          |             |       |    |          |                    |       |    |          |   |       |    |          |                          |       |    |          |            |       |    |          |                            |       |    |          |  |       |    |          |                    |       |    |          |  |       |    |          |  |       |    |          |  |       |    |          |                              |       |    |          |                          |       |    |          |                                 |       |    |          |                         |       |    |          |                          |       |    |          |                    |       |    |          |                        |       |    |          |                       |       |    |          |  |   |      |             |     |     |          |                        |       |    |          |  |       |    |          |                            |       |    |          |             |       |    |          |                     |       |    |          |                          |       |    |
|-----------|---|---|------------|--|--|------|-------------|-----|-----|----------|--|-------|----|----------|-------------|-------|----|----------|--------------------|-------|----|----------|---|-------|----|----------|--------------------------|-------|----|----------|------------|-------|----|----------|----------------------------|-------|----|----------|--|-------|----|----------|--------------------|-------|----|----------|--|-------|----|----------|--|-------|----|----------|--|-------|----|----------|------------------------------|-------|----|----------|--------------------------|-------|----|----------|---------------------------------|-------|----|----------|-------------------------|-------|----|----------|--------------------------|-------|----|----------|--------------------|-------|----|----------|------------------------|-------|----|----------|-----------------------|-------|----|----------|--|---|------|-------------|-----|-----|----------|------------------------|-------|----|----------|--|-------|----|----------|----------------------------|-------|----|----------|-------------|-------|----|----------|---------------------|-------|----|----------|--------------------------|-------|----|
| Code      | Description                             | Image   | Code       | Description                                    | Kit components   |      |             |     |     |          |  |       |    |          |             |       |    |          |                    |       |    |          |   |       |    |          |                          |       |    |          |            |       |    |          |                            |       |    |          |  |       |    |          |                    |       |    |          |  |       |    |          |  |       |    |          |  |       |    |          |                              |       |    |          |                          |       |    |          |                                 |       |    |          |                         |       |    |          |                          |       |    |          |                    |       |    |          |                        |       |    |          |                       |       |    |          |  |   |      |             |     |     |          |                        |       |    |          |  |       |    |          |                            |       |    |          |             |       |    |          |                     |       |    |          |                          |       |    |
| VM2039A   | DRAIN BEND FIXING RING                  |  | KVL1315A   | CBX<br>RECIRCULATION<br>TANK KIT (NO<br>PUMPS) | <table border="1"> <thead> <tr> <th>Code</th> <th>Description</th> <th>Qty</th> <th>UOM</th> </tr> </thead> <tbody> <tr> <td>0H6686A0</td> <td></td> <td>1.000</td> <td>PC</td> </tr> <tr> <td>GN1400A0</td> <td>U-TRAP SEAL</td> <td>1.000</td> <td>PC</td> </tr> <tr> <td>RC1019A0</td> <td>D=10 ELASTIC CLAMP</td> <td>2.000</td> <td>PC</td> </tr> <tr> <td>RC1243A0</td> <td>Ø10F-Ø10M ELBOW CONNECTION + JG END KIT</td> <td>1.000</td> <td>PC</td> </tr> <tr> <td>RC1360A0</td> <td>10 - 10 JG ELBOW FITTING</td> <td>2.000</td> <td>PC</td> </tr> <tr> <td>RC1378A0</td> <td>HOSE CLAMP</td> <td>1.000</td> <td>PC</td> </tr> <tr> <td>RC1410A0</td> <td>ST STEEL HOSE CLAMP D16-27</td> <td>2.000</td> <td>PC</td> </tr> <tr> <td>SN1053A0</td> <td></td> <td>1.000</td> <td>PC</td> </tr> <tr> <td>SN1061A0</td> <td>D4x175MM NTC PROBE</td> <td>1.000</td> <td>PC</td> </tr> <tr> <td>TB3822A0</td> <td></td> <td>1.000</td> <td>PC</td> </tr> <tr> <td>TB4135A0</td> <td></td> <td>1.000</td> <td>PC</td> </tr> <tr> <td>TB4160A0</td> <td></td> <td>1.000</td> <td>PC</td> </tr> <tr> <td>VI1103A0</td> <td>40X12 TBSP SCREW FOR PLASTIC</td> <td>6.000</td> <td>PC</td> </tr> <tr> <td>VL1315A1</td> <td>ASM TANK BLOCK PUMPS DID</td> <td>1.000</td> <td>PC</td> </tr> <tr> <td>VL1340A0</td> <td>DID JG 10 M-M BYPASS CONNECTION</td> <td>1.000</td> <td>PC</td> </tr> <tr> <td>VL1400A0</td> <td>PARTIAL EDGE BENT DRAIN</td> <td>1.000</td> <td>PC</td> </tr> <tr> <td>VL1407A0</td> <td>DID PRESSURE REDUCER SET</td> <td>1.000</td> <td>PC</td> </tr> <tr> <td>VM1802A0</td> <td>DID TANKS FLAP PIN</td> <td>1.000</td> <td>PC</td> </tr> <tr> <td>VM2039A0</td> <td>DRAIN BEND FIXING RING</td> <td>1.000</td> <td>PC</td> </tr> <tr> <td>VM2640A0</td> <td>DRAIN PUMP PROTECTION</td> <td>1.000</td> <td>PC</td> </tr> </tbody> </table> | Code | Description | Qty | UOM | 0H6686A0 |  | 1.000 | PC | GN1400A0 | U-TRAP SEAL | 1.000 | PC | RC1019A0 | D=10 ELASTIC CLAMP | 2.000 | PC | RC1243A0 | Ø10F-Ø10M ELBOW CONNECTION + JG END KIT | 1.000 | PC | RC1360A0 | 10 - 10 JG ELBOW FITTING | 2.000 | PC | RC1378A0 | HOSE CLAMP | 1.000 | PC | RC1410A0 | ST STEEL HOSE CLAMP D16-27 | 2.000 | PC | SN1053A0 |  | 1.000 | PC | SN1061A0 | D4x175MM NTC PROBE | 1.000 | PC | TB3822A0 |  | 1.000 | PC | TB4135A0 |  | 1.000 | PC | TB4160A0 |  | 1.000 | PC | VI1103A0 | 40X12 TBSP SCREW FOR PLASTIC | 6.000 | PC | VL1315A1 | ASM TANK BLOCK PUMPS DID | 1.000 | PC | VL1340A0 | DID JG 10 M-M BYPASS CONNECTION | 1.000 | PC | VL1400A0 | PARTIAL EDGE BENT DRAIN | 1.000 | PC | VL1407A0 | DID PRESSURE REDUCER SET | 1.000 | PC | VM1802A0 | DID TANKS FLAP PIN | 1.000 | PC | VM2039A0 | DRAIN BEND FIXING RING | 1.000 | PC | VM2640A0 | DRAIN PUMP PROTECTION | 1.000 | PC | KVL1310A | COMPLETE CBX<br>RECIRC TANK<br>GROUP KIT | <table border="1"> <thead> <tr> <th>Code</th> <th>Description</th> <th>Qty</th> <th>UOM</th> </tr> </thead> <tbody> <tr> <td>0H5760A0</td> <td>CN1016 CAPACITOR COVER</td> <td>1.000</td> <td>PC</td> </tr> <tr> <td>0H6686A0</td> <td></td> <td>1.000</td> <td>PC</td> </tr> <tr> <td>CN1016A0</td> <td>CE/UL 500V 2.5 µF CAPACITO</td> <td>1.000</td> <td>PC</td> </tr> <tr> <td>GN1400A0</td> <td>U-TRAP SEAL</td> <td>1.000</td> <td>PC</td> </tr> <tr> <td>PM1013A0</td> <td>240V 32W DRAIN PUMP</td> <td>1.000</td> <td>PC</td> </tr> <tr> <td>PM1018A0</td> <td>240V 100W RECYCLING PUMP</td> <td>1.000</td> <td>PC</td> </tr> </tbody> </table> | Code | Description | Qty | UOM | 0H5760A0 | CN1016 CAPACITOR COVER | 1.000 | PC | 0H6686A0 |  | 1.000 | PC | CN1016A0 | CE/UL 500V 2.5 µF CAPACITO | 1.000 | PC | GN1400A0 | U-TRAP SEAL | 1.000 | PC | PM1013A0 | 240V 32W DRAIN PUMP | 1.000 | PC | PM1018A0 | 240V 100W RECYCLING PUMP | 1.000 | PC |
|           |   |   | Code       | Description                                    | Qty  | UOM  |             |     |     |          |  |       |    |          |             |       |    |          |                    |       |    |          |   |       |    |          |                          |       |    |          |            |       |    |          |                            |       |    |          |  |       |    |          |                    |       |    |          |  |       |    |          |  |       |    |          |  |       |    |          |                              |       |    |          |                          |       |    |          |                                 |       |    |          |                         |       |    |          |                          |       |    |          |                    |       |    |          |                        |       |    |          |                       |       |    |          |  |   |      |             |     |     |          |                        |       |    |          |  |       |    |          |                            |       |    |          |             |       |    |          |                     |       |    |          |                          |       |    |
| 0H6686A0  |   | 1.000   | PC         |  |  |      |             |     |     |          |  |       |    |          |             |       |    |          |                    |       |    |          |   |       |    |          |                          |       |    |          |            |       |    |          |                            |       |    |          |  |       |    |          |                    |       |    |          |  |       |    |          |  |       |    |          |  |       |    |          |                              |       |    |          |                          |       |    |          |                                 |       |    |          |                         |       |    |          |                          |       |    |          |                    |       |    |          |                        |       |    |          |                       |       |    |          |  |   |      |             |     |     |          |                        |       |    |          |  |       |    |          |                            |       |    |          |             |       |    |          |                     |       |    |          |                          |       |    |
| GN1400A0  | U-TRAP SEAL                             | 1.000   | PC         |  |  |      |             |     |     |          |  |       |    |          |             |       |    |          |                    |       |    |          |   |       |    |          |                          |       |    |          |            |       |    |          |                            |       |    |          |  |       |    |          |                    |       |    |          |  |       |    |          |  |       |    |          |  |       |    |          |                              |       |    |          |                          |       |    |          |                                 |       |    |          |                         |       |    |          |                          |       |    |          |                    |       |    |          |                        |       |    |          |                       |       |    |          |  |   |      |             |     |     |          |                        |       |    |          |  |       |    |          |                            |       |    |          |             |       |    |          |                     |       |    |          |                          |       |    |
| RC1019A0  | D=10 ELASTIC CLAMP                      | 2.000   | PC         |  |  |      |             |     |     |          |  |       |    |          |             |       |    |          |                    |       |    |          |   |       |    |          |                          |       |    |          |            |       |    |          |                            |       |    |          |  |       |    |          |                    |       |    |          |  |       |    |          |  |       |    |          |  |       |    |          |                              |       |    |          |                          |       |    |          |                                 |       |    |          |                         |       |    |          |                          |       |    |          |                    |       |    |          |                        |       |    |          |                       |       |    |          |  |   |      |             |     |     |          |                        |       |    |          |  |       |    |          |                            |       |    |          |             |       |    |          |                     |       |    |          |                          |       |    |
| RC1243A0  | Ø10F-Ø10M ELBOW CONNECTION + JG END KIT | 1.000   | PC         |  |  |      |             |     |     |          |  |       |    |          |             |       |    |          |                    |       |    |          |   |       |    |          |                          |       |    |          |            |       |    |          |                            |       |    |          |  |       |    |          |                    |       |    |          |  |       |    |          |  |       |    |          |  |       |    |          |                              |       |    |          |                          |       |    |          |                                 |       |    |          |                         |       |    |          |                          |       |    |          |                    |       |    |          |                        |       |    |          |                       |       |    |          |  |   |      |             |     |     |          |                        |       |    |          |  |       |    |          |                            |       |    |          |             |       |    |          |                     |       |    |          |                          |       |    |
| RC1360A0  | 10 - 10 JG ELBOW FITTING                | 2.000   | PC         |  |  |      |             |     |     |          |  |       |    |          |             |       |    |          |                    |       |    |          |   |       |    |          |                          |       |    |          |            |       |    |          |                            |       |    |          |  |       |    |          |                    |       |    |          |  |       |    |          |  |       |    |          |  |       |    |          |                              |       |    |          |                          |       |    |          |                                 |       |    |          |                         |       |    |          |                          |       |    |          |                    |       |    |          |                        |       |    |          |                       |       |    |          |  |   |      |             |     |     |          |                        |       |    |          |  |       |    |          |                            |       |    |          |             |       |    |          |                     |       |    |          |                          |       |    |
| RC1378A0  | HOSE CLAMP                              | 1.000   | PC         |  |  |      |             |     |     |          |  |       |    |          |             |       |    |          |                    |       |    |          |   |       |    |          |                          |       |    |          |            |       |    |          |                            |       |    |          |  |       |    |          |                    |       |    |          |  |       |    |          |  |       |    |          |  |       |    |          |                              |       |    |          |                          |       |    |          |                                 |       |    |          |                         |       |    |          |                          |       |    |          |                    |       |    |          |                        |       |    |          |                       |       |    |          |  |   |      |             |     |     |          |                        |       |    |          |  |       |    |          |                            |       |    |          |             |       |    |          |                     |       |    |          |                          |       |    |
| RC1410A0  | ST STEEL HOSE CLAMP D16-27              | 2.000   | PC         |  |  |      |             |     |     |          |  |       |    |          |             |       |    |          |                    |       |    |          |   |       |    |          |                          |       |    |          |            |       |    |          |                            |       |    |          |  |       |    |          |                    |       |    |          |  |       |    |          |  |       |    |          |  |       |    |          |                              |       |    |          |                          |       |    |          |                                 |       |    |          |                         |       |    |          |                          |       |    |          |                    |       |    |          |                        |       |    |          |                       |       |    |          |  |   |      |             |     |     |          |                        |       |    |          |  |       |    |          |                            |       |    |          |             |       |    |          |                     |       |    |          |                          |       |    |
| SN1053A0  |   | 1.000   | PC         |  |  |      |             |     |     |          |  |       |    |          |             |       |    |          |                    |       |    |          |   |       |    |          |                          |       |    |          |            |       |    |          |                            |       |    |          |  |       |    |          |                    |       |    |          |  |       |    |          |  |       |    |          |  |       |    |          |                              |       |    |          |                          |       |    |          |                                 |       |    |          |                         |       |    |          |                          |       |    |          |                    |       |    |          |                        |       |    |          |                       |       |    |          |  |   |      |             |     |     |          |                        |       |    |          |  |       |    |          |                            |       |    |          |             |       |    |          |                     |       |    |          |                          |       |    |
| SN1061A0  | D4x175MM NTC PROBE                      | 1.000   | PC         |  |  |      |             |     |     |          |  |       |    |          |             |       |    |          |                    |       |    |          |   |       |    |          |                          |       |    |          |            |       |    |          |                            |       |    |          |  |       |    |          |                    |       |    |          |  |       |    |          |  |       |    |          |  |       |    |          |                              |       |    |          |                          |       |    |          |                                 |       |    |          |                         |       |    |          |                          |       |    |          |                    |       |    |          |                        |       |    |          |                       |       |    |          |  |   |      |             |     |     |          |                        |       |    |          |  |       |    |          |                            |       |    |          |             |       |    |          |                     |       |    |          |                          |       |    |
| TB3822A0  |   | 1.000   | PC         |  |  |      |             |     |     |          |  |       |    |          |             |       |    |          |                    |       |    |          |   |       |    |          |                          |       |    |          |            |       |    |          |                            |       |    |          |  |       |    |          |                    |       |    |          |  |       |    |          |  |       |    |          |  |       |    |          |                              |       |    |          |                          |       |    |          |                                 |       |    |          |                         |       |    |          |                          |       |    |          |                    |       |    |          |                        |       |    |          |                       |       |    |          |  |   |      |             |     |     |          |                        |       |    |          |  |       |    |          |                            |       |    |          |             |       |    |          |                     |       |    |          |                          |       |    |
| TB4135A0  |   | 1.000   | PC         |  |  |      |             |     |     |          |  |       |    |          |             |       |    |          |                    |       |    |          |   |       |    |          |                          |       |    |          |            |       |    |          |                            |       |    |          |  |       |    |          |                    |       |    |          |  |       |    |          |  |       |    |          |  |       |    |          |                              |       |    |          |                          |       |    |          |                                 |       |    |          |                         |       |    |          |                          |       |    |          |                    |       |    |          |                        |       |    |          |                       |       |    |          |  |   |      |             |     |     |          |                        |       |    |          |  |       |    |          |                            |       |    |          |             |       |    |          |                     |       |    |          |                          |       |    |
| TB4160A0  |   | 1.000   | PC         |  |  |      |             |     |     |          |  |       |    |          |             |       |    |          |                    |       |    |          |   |       |    |          |                          |       |    |          |            |       |    |          |                            |       |    |          |  |       |    |          |                    |       |    |          |  |       |    |          |  |       |    |          |  |       |    |          |                              |       |    |          |                          |       |    |          |                                 |       |    |          |                         |       |    |          |                          |       |    |          |                    |       |    |          |                        |       |    |          |                       |       |    |          |  |   |      |             |     |     |          |                        |       |    |          |  |       |    |          |                            |       |    |          |             |       |    |          |                     |       |    |          |                          |       |    |
| VI1103A0  | 40X12 TBSP SCREW FOR PLASTIC            | 6.000   | PC         |  |  |      |             |     |     |          |  |       |    |          |             |       |    |          |                    |       |    |          |   |       |    |          |                          |       |    |          |            |       |    |          |                            |       |    |          |  |       |    |          |                    |       |    |          |  |       |    |          |  |       |    |          |  |       |    |          |                              |       |    |          |                          |       |    |          |                                 |       |    |          |                         |       |    |          |                          |       |    |          |                    |       |    |          |                        |       |    |          |                       |       |    |          |  |   |      |             |     |     |          |                        |       |    |          |  |       |    |          |                            |       |    |          |             |       |    |          |                     |       |    |          |                          |       |    |
| VL1315A1  | ASM TANK BLOCK PUMPS DID                | 1.000   | PC         |  |  |      |             |     |     |          |  |       |    |          |             |       |    |          |                    |       |    |          |   |       |    |          |                          |       |    |          |            |       |    |          |                            |       |    |          |  |       |    |          |                    |       |    |          |  |       |    |          |  |       |    |          |  |       |    |          |                              |       |    |          |                          |       |    |          |                                 |       |    |          |                         |       |    |          |                          |       |    |          |                    |       |    |          |                        |       |    |          |                       |       |    |          |  |   |      |             |     |     |          |                        |       |    |          |  |       |    |          |                            |       |    |          |             |       |    |          |                     |       |    |          |                          |       |    |
| VL1340A0  | DID JG 10 M-M BYPASS CONNECTION         | 1.000   | PC         |  |  |      |             |     |     |          |  |       |    |          |             |       |    |          |                    |       |    |          |   |       |    |          |                          |       |    |          |            |       |    |          |                            |       |    |          |  |       |    |          |                    |       |    |          |  |       |    |          |  |       |    |          |  |       |    |          |                              |       |    |          |                          |       |    |          |                                 |       |    |          |                         |       |    |          |                          |       |    |          |                    |       |    |          |                        |       |    |          |                       |       |    |          |  |   |      |             |     |     |          |                        |       |    |          |  |       |    |          |                            |       |    |          |             |       |    |          |                     |       |    |          |                          |       |    |
| VL1400A0  | PARTIAL EDGE BENT DRAIN                 | 1.000   | PC         |  |  |      |             |     |     |          |  |       |    |          |             |       |    |          |                    |       |    |          |   |       |    |          |                          |       |    |          |            |       |    |          |                            |       |    |          |  |       |    |          |                    |       |    |          |  |       |    |          |  |       |    |          |  |       |    |          |                              |       |    |          |                          |       |    |          |                                 |       |    |          |                         |       |    |          |                          |       |    |          |                    |       |    |          |                        |       |    |          |                       |       |    |          |  |   |      |             |     |     |          |                        |       |    |          |  |       |    |          |                            |       |    |          |             |       |    |          |                     |       |    |          |                          |       |    |
| VL1407A0  | DID PRESSURE REDUCER SET                | 1.000   | PC         |  |  |      |             |     |     |          |  |       |    |          |             |       |    |          |                    |       |    |          |   |       |    |          |                          |       |    |          |            |       |    |          |                            |       |    |          |  |       |    |          |                    |       |    |          |  |       |    |          |  |       |    |          |  |       |    |          |                              |       |    |          |                          |       |    |          |                                 |       |    |          |                         |       |    |          |                          |       |    |          |                    |       |    |          |                        |       |    |          |                       |       |    |          |  |   |      |             |     |     |          |                        |       |    |          |  |       |    |          |                            |       |    |          |             |       |    |          |                     |       |    |          |                          |       |    |
| VM1802A0  | DID TANKS FLAP PIN                      | 1.000   | PC         |  |  |      |             |     |     |          |  |       |    |          |             |       |    |          |                    |       |    |          |   |       |    |          |                          |       |    |          |            |       |    |          |                            |       |    |          |  |       |    |          |                    |       |    |          |  |       |    |          |  |       |    |          |  |       |    |          |                              |       |    |          |                          |       |    |          |                                 |       |    |          |                         |       |    |          |                          |       |    |          |                    |       |    |          |                        |       |    |          |                       |       |    |          |  |   |      |             |     |     |          |                        |       |    |          |  |       |    |          |                            |       |    |          |             |       |    |          |                     |       |    |          |                          |       |    |
| VM2039A0  | DRAIN BEND FIXING RING                  | 1.000   | PC         |  |  |      |             |     |     |          |  |       |    |          |             |       |    |          |                    |       |    |          |   |       |    |          |                          |       |    |          |            |       |    |          |                            |       |    |          |  |       |    |          |                    |       |    |          |  |       |    |          |  |       |    |          |  |       |    |          |                              |       |    |          |                          |       |    |          |                                 |       |    |          |                         |       |    |          |                          |       |    |          |                    |       |    |          |                        |       |    |          |                       |       |    |          |  |   |      |             |     |     |          |                        |       |    |          |  |       |    |          |                            |       |    |          |             |       |    |          |                     |       |    |          |                          |       |    |
| VM2640A0  | DRAIN PUMP PROTECTION                   | 1.000   | PC         |  |  |      |             |     |     |          |  |       |    |          |             |       |    |          |                    |       |    |          |   |       |    |          |                          |       |    |          |            |       |    |          |                            |       |    |          |  |       |    |          |                    |       |    |          |  |       |    |          |  |       |    |          |  |       |    |          |                              |       |    |          |                          |       |    |          |                                 |       |    |          |                         |       |    |          |                          |       |    |          |                    |       |    |          |                        |       |    |          |                       |       |    |          |  |   |      |             |     |     |          |                        |       |    |          |  |       |    |          |                            |       |    |          |             |       |    |          |                     |       |    |          |                          |       |    |
| Code      | Description                             | Qty   | UOM        |  |  |      |             |     |     |          |  |       |    |          |             |       |    |          |                    |       |    |          |   |       |    |          |                          |       |    |          |            |       |    |          |                            |       |    |          |  |       |    |          |                    |       |    |          |  |       |    |          |  |       |    |          |  |       |    |          |                              |       |    |          |                          |       |    |          |                                 |       |    |          |                         |       |    |          |                          |       |    |          |                    |       |    |          |                        |       |    |          |                       |       |    |          |  |   |      |             |     |     |          |                        |       |    |          |  |       |    |          |                            |       |    |          |             |       |    |          |                     |       |    |          |                          |       |    |
| 0H5760A0  | CN1016 CAPACITOR COVER                  | 1.000   | PC         |  |  |      |             |     |     |          |  |       |    |          |             |       |    |          |                    |       |    |          |   |       |    |          |                          |       |    |          |            |       |    |          |                            |       |    |          |  |       |    |          |                    |       |    |          |  |       |    |          |  |       |    |          |  |       |    |          |                              |       |    |          |                          |       |    |          |                                 |       |    |          |                         |       |    |          |                          |       |    |          |                    |       |    |          |                        |       |    |          |                       |       |    |          |  |   |      |             |     |     |          |                        |       |    |          |  |       |    |          |                            |       |    |          |             |       |    |          |                     |       |    |          |                          |       |    |
| 0H6686A0  |   | 1.000   | PC         |  |  |      |             |     |     |          |  |       |    |          |             |       |    |          |                    |       |    |          |   |       |    |          |                          |       |    |          |            |       |    |          |                            |       |    |          |  |       |    |          |                    |       |    |          |  |       |    |          |  |       |    |          |  |       |    |          |                              |       |    |          |                          |       |    |          |                                 |       |    |          |                         |       |    |          |                          |       |    |          |                    |       |    |          |                        |       |    |          |                       |       |    |          |  |   |      |             |     |     |          |                        |       |    |          |  |       |    |          |                            |       |    |          |             |       |    |          |                     |       |    |          |                          |       |    |
| CN1016A0  | CE/UL 500V 2.5 µF CAPACITO              | 1.000   | PC         |  |  |      |             |     |     |          |  |       |    |          |             |       |    |          |                    |       |    |          |   |       |    |          |                          |       |    |          |            |       |    |          |                            |       |    |          |  |       |    |          |                    |       |    |          |  |       |    |          |  |       |    |          |  |       |    |          |                              |       |    |          |                          |       |    |          |                                 |       |    |          |                         |       |    |          |                          |       |    |          |                    |       |    |          |                        |       |    |          |                       |       |    |          |  |   |      |             |     |     |          |                        |       |    |          |  |       |    |          |                            |       |    |          |             |       |    |          |                     |       |    |          |                          |       |    |
| GN1400A0  | U-TRAP SEAL                             | 1.000   | PC         |  |  |      |             |     |     |          |  |       |    |          |             |       |    |          |                    |       |    |          |   |       |    |          |                          |       |    |          |            |       |    |          |                            |       |    |          |  |       |    |          |                    |       |    |          |  |       |    |          |  |       |    |          |  |       |    |          |                              |       |    |          |                          |       |    |          |                                 |       |    |          |                         |       |    |          |                          |       |    |          |                    |       |    |          |                        |       |    |          |                       |       |    |          |  |   |      |             |     |     |          |                        |       |    |          |  |       |    |          |                            |       |    |          |             |       |    |          |                     |       |    |          |                          |       |    |
| PM1013A0  | 240V 32W DRAIN PUMP                     | 1.000   | PC         |  |  |      |             |     |     |          |  |       |    |          |             |       |    |          |                    |       |    |          |   |       |    |          |                          |       |    |          |            |       |    |          |                            |       |    |          |  |       |    |          |                    |       |    |          |  |       |    |          |  |       |    |          |  |       |    |          |                              |       |    |          |                          |       |    |          |                                 |       |    |          |                         |       |    |          |                          |       |    |          |                    |       |    |          |                        |       |    |          |                       |       |    |          |  |   |      |             |     |     |          |                        |       |    |          |  |       |    |          |                            |       |    |          |             |       |    |          |                     |       |    |          |                          |       |    |
| PM1018A0  | 240V 100W RECYCLING PUMP                | 1.000   | PC         |  |  |      |             |     |     |          |  |       |    |          |             |       |    |          |                    |       |    |          |   |       |    |          |                          |       |    |          |            |       |    |          |                            |       |    |          |  |       |    |          |                    |       |    |          |  |       |    |          |  |       |    |          |  |       |    |          |                              |       |    |          |                          |       |    |          |                                 |       |    |          |                         |       |    |          |                          |       |    |          |                    |       |    |          |                        |       |    |          |                       |       |    |          |  |   |      |             |     |     |          |                        |       |    |          |  |       |    |          |                            |       |    |          |             |       |    |          |                     |       |    |          |                          |       |    |



| COMPONENT |   |   | SPARE PART |                                    |   |      |             |     |     |          |                    |       |    |          |                               |       |    |          |   |       |    |          |                          |       |    |          |            |       |    |          |                            |       |    |          |  |       |    |          |                    |       |    |          |  |       |    |          |  |       |    |          |  |       |    |          |                              |       |    |          |                               |       |    |          |                                      |       |    |          |                          |       |    |          |                             |       |    |          |                 |       |    |          |              |       |    |          |                                 |       |    |          |                         |       |    |          |                          |       |    |          |                          |       |    |          |                    |       |    |          |                        |       |    |          |                       |       |    |
|-----------|---|---|------------|------------------------------------|---|------|-------------|-----|-----|----------|--------------------|-------|----|----------|-------------------------------|-------|----|----------|---|-------|----|----------|--------------------------|-------|----|----------|------------|-------|----|----------|----------------------------|-------|----|----------|--|-------|----|----------|--------------------|-------|----|----------|--|-------|----|----------|--|-------|----|----------|--|-------|----|----------|------------------------------|-------|----|----------|-------------------------------|-------|----|----------|--------------------------------------|-------|----|----------|--------------------------|-------|----|----------|-----------------------------|-------|----|----------|-----------------|-------|----|----------|--------------|-------|----|----------|---------------------------------|-------|----|----------|-------------------------|-------|----|----------|--------------------------|-------|----|----------|--------------------------|-------|----|----------|--------------------|-------|----|----------|------------------------|-------|----|----------|-----------------------|-------|----|
| Code      | Description                             | Image   | Code       | Description                        | Kit components  |      |             |     |     |          |                    |       |    |          |                               |       |    |          |   |       |    |          |                          |       |    |          |            |       |    |          |                            |       |    |          |  |       |    |          |                    |       |    |          |  |       |    |          |  |       |    |          |  |       |    |          |                              |       |    |          |                               |       |    |          |                                      |       |    |          |                          |       |    |          |                             |       |    |          |                 |       |    |          |              |       |    |          |                                 |       |    |          |                         |       |    |          |                          |       |    |          |                          |       |    |          |                    |       |    |          |                        |       |    |          |                       |       |    |
| VM2039A   | DRAIN BEND FIXING RING                  |  | KVL1310A   | COMPLETE CBX RECIRC TANK GROUP KIT | <table border="1"> <thead> <tr> <th>Code</th> <th>Description</th> <th>Qty</th> <th>UOM</th> </tr> </thead> <tbody> <tr> <td>RC1019A0</td> <td>D=10 ELASTIC CLAMP</td> <td>2.000</td> <td>PC</td> </tr> <tr> <td>RC1046A0</td> <td>D10-16 H9 ST STEEL HOSE CLAMP</td> <td>1.000</td> <td>PC</td> </tr> <tr> <td>RC1243A0</td> <td>Ø10F-Ø10M ELBOW CONNECTION + JG END KIT</td> <td>1.000</td> <td>PC</td> </tr> <tr> <td>RC1360A0</td> <td>10 - 10 JG ELBOW FITTING</td> <td>2.000</td> <td>PC</td> </tr> <tr> <td>RC1378A0</td> <td>HOSE CLAMP</td> <td>1.000</td> <td>PC</td> </tr> <tr> <td>RC1410A0</td> <td>ST STEEL HOSE CLAMP D16-27</td> <td>6.000</td> <td>PC</td> </tr> <tr> <td>SN1053A0</td> <td></td> <td>1.000</td> <td>PC</td> </tr> <tr> <td>SN1061A0</td> <td>D4x175MM NTC PROBE</td> <td>1.000</td> <td>PC</td> </tr> <tr> <td>TB3822A0</td> <td></td> <td>2.000</td> <td>PC</td> </tr> <tr> <td>TB4135A0</td> <td></td> <td>1.000</td> <td>PC</td> </tr> <tr> <td>TB4160A0</td> <td></td> <td>1.000</td> <td>PC</td> </tr> <tr> <td>VI1103A0</td> <td>40X12 TBSP SCREW FOR PLASTIC</td> <td>9.000</td> <td>PC</td> </tr> <tr> <td>VI1220A1</td> <td>4,2x12 TCB SELF-TAPPING SCREW</td> <td>2.000</td> <td>PC</td> </tr> <tr> <td>VL1178A0</td> <td>EPDM O-RING INNER D 10.8 STRING 1.78</td> <td>2.000</td> <td>PC</td> </tr> <tr> <td>VL1315A1</td> <td>ASM TANK BLOCK PUMPS DID</td> <td>1.000</td> <td>PC</td> </tr> <tr> <td>VL1318A0</td> <td>SUPPORTO POMPA RICIRCOLO DI</td> <td>1.000</td> <td>PC</td> </tr> <tr> <td>VL1329A0</td> <td>D24-D16 FITTING</td> <td>1.000</td> <td>PC</td> </tr> <tr> <td>VL1332A0</td> <td>DID TANK CAP</td> <td>1.000</td> <td>PC</td> </tr> <tr> <td>VL1340A0</td> <td>DID JG 10 M-M BYPASS CONNECTION</td> <td>1.000</td> <td>PC</td> </tr> <tr> <td>VL1400A0</td> <td>PARTIAL EDGE BENT DRAIN</td> <td>1.000</td> <td>PC</td> </tr> <tr> <td>VL1407A0</td> <td>DID PRESSURE REDUCER SET</td> <td>1.000</td> <td>PC</td> </tr> <tr> <td>VM1794A0</td> <td>250x4.8 PA66 BLACK CLAMP</td> <td>1.000</td> <td>PC</td> </tr> <tr> <td>VM1802A0</td> <td>DID TANKS FLAP PIN</td> <td>1.000</td> <td>PC</td> </tr> <tr> <td>VM2039A0</td> <td>DRAIN BEND FIXING RING</td> <td>1.000</td> <td>PC</td> </tr> <tr> <td>VM2640A0</td> <td>DRAIN PUMP PROTECTION</td> <td>1.000</td> <td>PC</td> </tr> </tbody> </table> | Code | Description | Qty | UOM | RC1019A0 | D=10 ELASTIC CLAMP | 2.000 | PC | RC1046A0 | D10-16 H9 ST STEEL HOSE CLAMP | 1.000 | PC | RC1243A0 | Ø10F-Ø10M ELBOW CONNECTION + JG END KIT | 1.000 | PC | RC1360A0 | 10 - 10 JG ELBOW FITTING | 2.000 | PC | RC1378A0 | HOSE CLAMP | 1.000 | PC | RC1410A0 | ST STEEL HOSE CLAMP D16-27 | 6.000 | PC | SN1053A0 |  | 1.000 | PC | SN1061A0 | D4x175MM NTC PROBE | 1.000 | PC | TB3822A0 |  | 2.000 | PC | TB4135A0 |  | 1.000 | PC | TB4160A0 |  | 1.000 | PC | VI1103A0 | 40X12 TBSP SCREW FOR PLASTIC | 9.000 | PC | VI1220A1 | 4,2x12 TCB SELF-TAPPING SCREW | 2.000 | PC | VL1178A0 | EPDM O-RING INNER D 10.8 STRING 1.78 | 2.000 | PC | VL1315A1 | ASM TANK BLOCK PUMPS DID | 1.000 | PC | VL1318A0 | SUPPORTO POMPA RICIRCOLO DI | 1.000 | PC | VL1329A0 | D24-D16 FITTING | 1.000 | PC | VL1332A0 | DID TANK CAP | 1.000 | PC | VL1340A0 | DID JG 10 M-M BYPASS CONNECTION | 1.000 | PC | VL1400A0 | PARTIAL EDGE BENT DRAIN | 1.000 | PC | VL1407A0 | DID PRESSURE REDUCER SET | 1.000 | PC | VM1794A0 | 250x4.8 PA66 BLACK CLAMP | 1.000 | PC | VM1802A0 | DID TANKS FLAP PIN | 1.000 | PC | VM2039A0 | DRAIN BEND FIXING RING | 1.000 | PC | VM2640A0 | DRAIN PUMP PROTECTION | 1.000 | PC |
| Code      | Description                             | Qty   | UOM        |                                    |   |      |             |     |     |          |                    |       |    |          |                               |       |    |          |   |       |    |          |                          |       |    |          |            |       |    |          |                            |       |    |          |  |       |    |          |                    |       |    |          |  |       |    |          |  |       |    |          |  |       |    |          |                              |       |    |          |                               |       |    |          |                                      |       |    |          |                          |       |    |          |                             |       |    |          |                 |       |    |          |              |       |    |          |                                 |       |    |          |                         |       |    |          |                          |       |    |          |                          |       |    |          |                    |       |    |          |                        |       |    |          |                       |       |    |
| RC1019A0  | D=10 ELASTIC CLAMP                      | 2.000   | PC         |                                    |   |      |             |     |     |          |                    |       |    |          |                               |       |    |          |   |       |    |          |                          |       |    |          |            |       |    |          |                            |       |    |          |  |       |    |          |                    |       |    |          |  |       |    |          |  |       |    |          |  |       |    |          |                              |       |    |          |                               |       |    |          |                                      |       |    |          |                          |       |    |          |                             |       |    |          |                 |       |    |          |              |       |    |          |                                 |       |    |          |                         |       |    |          |                          |       |    |          |                          |       |    |          |                    |       |    |          |                        |       |    |          |                       |       |    |
| RC1046A0  | D10-16 H9 ST STEEL HOSE CLAMP           | 1.000   | PC         |                                    |   |      |             |     |     |          |                    |       |    |          |                               |       |    |          |   |       |    |          |                          |       |    |          |            |       |    |          |                            |       |    |          |  |       |    |          |                    |       |    |          |  |       |    |          |  |       |    |          |  |       |    |          |                              |       |    |          |                               |       |    |          |                                      |       |    |          |                          |       |    |          |                             |       |    |          |                 |       |    |          |              |       |    |          |                                 |       |    |          |                         |       |    |          |                          |       |    |          |                          |       |    |          |                    |       |    |          |                        |       |    |          |                       |       |    |
| RC1243A0  | Ø10F-Ø10M ELBOW CONNECTION + JG END KIT | 1.000   | PC         |                                    |   |      |             |     |     |          |                    |       |    |          |                               |       |    |          |   |       |    |          |                          |       |    |          |            |       |    |          |                            |       |    |          |  |       |    |          |                    |       |    |          |  |       |    |          |  |       |    |          |  |       |    |          |                              |       |    |          |                               |       |    |          |                                      |       |    |          |                          |       |    |          |                             |       |    |          |                 |       |    |          |              |       |    |          |                                 |       |    |          |                         |       |    |          |                          |       |    |          |                          |       |    |          |                    |       |    |          |                        |       |    |          |                       |       |    |
| RC1360A0  | 10 - 10 JG ELBOW FITTING                | 2.000   | PC         |                                    |   |      |             |     |     |          |                    |       |    |          |                               |       |    |          |   |       |    |          |                          |       |    |          |            |       |    |          |                            |       |    |          |  |       |    |          |                    |       |    |          |  |       |    |          |  |       |    |          |  |       |    |          |                              |       |    |          |                               |       |    |          |                                      |       |    |          |                          |       |    |          |                             |       |    |          |                 |       |    |          |              |       |    |          |                                 |       |    |          |                         |       |    |          |                          |       |    |          |                          |       |    |          |                    |       |    |          |                        |       |    |          |                       |       |    |
| RC1378A0  | HOSE CLAMP                              | 1.000   | PC         |                                    |   |      |             |     |     |          |                    |       |    |          |                               |       |    |          |   |       |    |          |                          |       |    |          |            |       |    |          |                            |       |    |          |  |       |    |          |                    |       |    |          |  |       |    |          |  |       |    |          |  |       |    |          |                              |       |    |          |                               |       |    |          |                                      |       |    |          |                          |       |    |          |                             |       |    |          |                 |       |    |          |              |       |    |          |                                 |       |    |          |                         |       |    |          |                          |       |    |          |                          |       |    |          |                    |       |    |          |                        |       |    |          |                       |       |    |
| RC1410A0  | ST STEEL HOSE CLAMP D16-27              | 6.000   | PC         |                                    |   |      |             |     |     |          |                    |       |    |          |                               |       |    |          |   |       |    |          |                          |       |    |          |            |       |    |          |                            |       |    |          |  |       |    |          |                    |       |    |          |  |       |    |          |  |       |    |          |  |       |    |          |                              |       |    |          |                               |       |    |          |                                      |       |    |          |                          |       |    |          |                             |       |    |          |                 |       |    |          |              |       |    |          |                                 |       |    |          |                         |       |    |          |                          |       |    |          |                          |       |    |          |                    |       |    |          |                        |       |    |          |                       |       |    |
| SN1053A0  |   | 1.000   | PC         |                                    |   |      |             |     |     |          |                    |       |    |          |                               |       |    |          |   |       |    |          |                          |       |    |          |            |       |    |          |                            |       |    |          |  |       |    |          |                    |       |    |          |  |       |    |          |  |       |    |          |  |       |    |          |                              |       |    |          |                               |       |    |          |                                      |       |    |          |                          |       |    |          |                             |       |    |          |                 |       |    |          |              |       |    |          |                                 |       |    |          |                         |       |    |          |                          |       |    |          |                          |       |    |          |                    |       |    |          |                        |       |    |          |                       |       |    |
| SN1061A0  | D4x175MM NTC PROBE                      | 1.000   | PC         |                                    |   |      |             |     |     |          |                    |       |    |          |                               |       |    |          |   |       |    |          |                          |       |    |          |            |       |    |          |                            |       |    |          |  |       |    |          |                    |       |    |          |  |       |    |          |  |       |    |          |  |       |    |          |                              |       |    |          |                               |       |    |          |                                      |       |    |          |                          |       |    |          |                             |       |    |          |                 |       |    |          |              |       |    |          |                                 |       |    |          |                         |       |    |          |                          |       |    |          |                          |       |    |          |                    |       |    |          |                        |       |    |          |                       |       |    |
| TB3822A0  |   | 2.000   | PC         |                                    |   |      |             |     |     |          |                    |       |    |          |                               |       |    |          |   |       |    |          |                          |       |    |          |            |       |    |          |                            |       |    |          |  |       |    |          |                    |       |    |          |  |       |    |          |  |       |    |          |  |       |    |          |                              |       |    |          |                               |       |    |          |                                      |       |    |          |                          |       |    |          |                             |       |    |          |                 |       |    |          |              |       |    |          |                                 |       |    |          |                         |       |    |          |                          |       |    |          |                          |       |    |          |                    |       |    |          |                        |       |    |          |                       |       |    |
| TB4135A0  |   | 1.000   | PC         |                                    |   |      |             |     |     |          |                    |       |    |          |                               |       |    |          |   |       |    |          |                          |       |    |          |            |       |    |          |                            |       |    |          |  |       |    |          |                    |       |    |          |  |       |    |          |  |       |    |          |  |       |    |          |                              |       |    |          |                               |       |    |          |                                      |       |    |          |                          |       |    |          |                             |       |    |          |                 |       |    |          |              |       |    |          |                                 |       |    |          |                         |       |    |          |                          |       |    |          |                          |       |    |          |                    |       |    |          |                        |       |    |          |                       |       |    |
| TB4160A0  |   | 1.000   | PC         |                                    |   |      |             |     |     |          |                    |       |    |          |                               |       |    |          |   |       |    |          |                          |       |    |          |            |       |    |          |                            |       |    |          |  |       |    |          |                    |       |    |          |  |       |    |          |  |       |    |          |  |       |    |          |                              |       |    |          |                               |       |    |          |                                      |       |    |          |                          |       |    |          |                             |       |    |          |                 |       |    |          |              |       |    |          |                                 |       |    |          |                         |       |    |          |                          |       |    |          |                          |       |    |          |                    |       |    |          |                        |       |    |          |                       |       |    |
| VI1103A0  | 40X12 TBSP SCREW FOR PLASTIC            | 9.000   | PC         |                                    |   |      |             |     |     |          |                    |       |    |          |                               |       |    |          |   |       |    |          |                          |       |    |          |            |       |    |          |                            |       |    |          |  |       |    |          |                    |       |    |          |  |       |    |          |  |       |    |          |  |       |    |          |                              |       |    |          |                               |       |    |          |                                      |       |    |          |                          |       |    |          |                             |       |    |          |                 |       |    |          |              |       |    |          |                                 |       |    |          |                         |       |    |          |                          |       |    |          |                          |       |    |          |                    |       |    |          |                        |       |    |          |                       |       |    |
| VI1220A1  | 4,2x12 TCB SELF-TAPPING SCREW           | 2.000   | PC         |                                    |   |      |             |     |     |          |                    |       |    |          |                               |       |    |          |   |       |    |          |                          |       |    |          |            |       |    |          |                            |       |    |          |  |       |    |          |                    |       |    |          |  |       |    |          |  |       |    |          |  |       |    |          |                              |       |    |          |                               |       |    |          |                                      |       |    |          |                          |       |    |          |                             |       |    |          |                 |       |    |          |              |       |    |          |                                 |       |    |          |                         |       |    |          |                          |       |    |          |                          |       |    |          |                    |       |    |          |                        |       |    |          |                       |       |    |
| VL1178A0  | EPDM O-RING INNER D 10.8 STRING 1.78    | 2.000   | PC         |                                    |   |      |             |     |     |          |                    |       |    |          |                               |       |    |          |   |       |    |          |                          |       |    |          |            |       |    |          |                            |       |    |          |  |       |    |          |                    |       |    |          |  |       |    |          |  |       |    |          |  |       |    |          |                              |       |    |          |                               |       |    |          |                                      |       |    |          |                          |       |    |          |                             |       |    |          |                 |       |    |          |              |       |    |          |                                 |       |    |          |                         |       |    |          |                          |       |    |          |                          |       |    |          |                    |       |    |          |                        |       |    |          |                       |       |    |
| VL1315A1  | ASM TANK BLOCK PUMPS DID                | 1.000   | PC         |                                    |   |      |             |     |     |          |                    |       |    |          |                               |       |    |          |   |       |    |          |                          |       |    |          |            |       |    |          |                            |       |    |          |  |       |    |          |                    |       |    |          |  |       |    |          |  |       |    |          |  |       |    |          |                              |       |    |          |                               |       |    |          |                                      |       |    |          |                          |       |    |          |                             |       |    |          |                 |       |    |          |              |       |    |          |                                 |       |    |          |                         |       |    |          |                          |       |    |          |                          |       |    |          |                    |       |    |          |                        |       |    |          |                       |       |    |
| VL1318A0  | SUPPORTO POMPA RICIRCOLO DI             | 1.000   | PC         |                                    |   |      |             |     |     |          |                    |       |    |          |                               |       |    |          |   |       |    |          |                          |       |    |          |            |       |    |          |                            |       |    |          |  |       |    |          |                    |       |    |          |  |       |    |          |  |       |    |          |  |       |    |          |                              |       |    |          |                               |       |    |          |                                      |       |    |          |                          |       |    |          |                             |       |    |          |                 |       |    |          |              |       |    |          |                                 |       |    |          |                         |       |    |          |                          |       |    |          |                          |       |    |          |                    |       |    |          |                        |       |    |          |                       |       |    |
| VL1329A0  | D24-D16 FITTING                         | 1.000   | PC         |                                    |   |      |             |     |     |          |                    |       |    |          |                               |       |    |          |   |       |    |          |                          |       |    |          |            |       |    |          |                            |       |    |          |  |       |    |          |                    |       |    |          |  |       |    |          |  |       |    |          |  |       |    |          |                              |       |    |          |                               |       |    |          |                                      |       |    |          |                          |       |    |          |                             |       |    |          |                 |       |    |          |              |       |    |          |                                 |       |    |          |                         |       |    |          |                          |       |    |          |                          |       |    |          |                    |       |    |          |                        |       |    |          |                       |       |    |
| VL1332A0  | DID TANK CAP                            | 1.000   | PC         |                                    |   |      |             |     |     |          |                    |       |    |          |                               |       |    |          |   |       |    |          |                          |       |    |          |            |       |    |          |                            |       |    |          |  |       |    |          |                    |       |    |          |  |       |    |          |  |       |    |          |  |       |    |          |                              |       |    |          |                               |       |    |          |                                      |       |    |          |                          |       |    |          |                             |       |    |          |                 |       |    |          |              |       |    |          |                                 |       |    |          |                         |       |    |          |                          |       |    |          |                          |       |    |          |                    |       |    |          |                        |       |    |          |                       |       |    |
| VL1340A0  | DID JG 10 M-M BYPASS CONNECTION         | 1.000   | PC         |                                    |   |      |             |     |     |          |                    |       |    |          |                               |       |    |          |   |       |    |          |                          |       |    |          |            |       |    |          |                            |       |    |          |  |       |    |          |                    |       |    |          |  |       |    |          |  |       |    |          |  |       |    |          |                              |       |    |          |                               |       |    |          |                                      |       |    |          |                          |       |    |          |                             |       |    |          |                 |       |    |          |              |       |    |          |                                 |       |    |          |                         |       |    |          |                          |       |    |          |                          |       |    |          |                    |       |    |          |                        |       |    |          |                       |       |    |
| VL1400A0  | PARTIAL EDGE BENT DRAIN                 | 1.000   | PC         |                                    |   |      |             |     |     |          |                    |       |    |          |                               |       |    |          |   |       |    |          |                          |       |    |          |            |       |    |          |                            |       |    |          |  |       |    |          |                    |       |    |          |  |       |    |          |  |       |    |          |  |       |    |          |                              |       |    |          |                               |       |    |          |                                      |       |    |          |                          |       |    |          |                             |       |    |          |                 |       |    |          |              |       |    |          |                                 |       |    |          |                         |       |    |          |                          |       |    |          |                          |       |    |          |                    |       |    |          |                        |       |    |          |                       |       |    |
| VL1407A0  | DID PRESSURE REDUCER SET                | 1.000   | PC         |                                    |   |      |             |     |     |          |                    |       |    |          |                               |       |    |          |   |       |    |          |                          |       |    |          |            |       |    |          |                            |       |    |          |  |       |    |          |                    |       |    |          |  |       |    |          |  |       |    |          |  |       |    |          |                              |       |    |          |                               |       |    |          |                                      |       |    |          |                          |       |    |          |                             |       |    |          |                 |       |    |          |              |       |    |          |                                 |       |    |          |                         |       |    |          |                          |       |    |          |                          |       |    |          |                    |       |    |          |                        |       |    |          |                       |       |    |
| VM1794A0  | 250x4.8 PA66 BLACK CLAMP                | 1.000   | PC         |                                    |   |      |             |     |     |          |                    |       |    |          |                               |       |    |          |   |       |    |          |                          |       |    |          |            |       |    |          |                            |       |    |          |  |       |    |          |                    |       |    |          |  |       |    |          |  |       |    |          |  |       |    |          |                              |       |    |          |                               |       |    |          |                                      |       |    |          |                          |       |    |          |                             |       |    |          |                 |       |    |          |              |       |    |          |                                 |       |    |          |                         |       |    |          |                          |       |    |          |                          |       |    |          |                    |       |    |          |                        |       |    |          |                       |       |    |
| VM1802A0  | DID TANKS FLAP PIN                      | 1.000   | PC         |                                    |   |      |             |     |     |          |                    |       |    |          |                               |       |    |          |   |       |    |          |                          |       |    |          |            |       |    |          |                            |       |    |          |  |       |    |          |                    |       |    |          |  |       |    |          |  |       |    |          |  |       |    |          |                              |       |    |          |                               |       |    |          |                                      |       |    |          |                          |       |    |          |                             |       |    |          |                 |       |    |          |              |       |    |          |                                 |       |    |          |                         |       |    |          |                          |       |    |          |                          |       |    |          |                    |       |    |          |                        |       |    |          |                       |       |    |
| VM2039A0  | DRAIN BEND FIXING RING                  | 1.000   | PC         |                                    |   |      |             |     |     |          |                    |       |    |          |                               |       |    |          |   |       |    |          |                          |       |    |          |            |       |    |          |                            |       |    |          |  |       |    |          |                    |       |    |          |  |       |    |          |  |       |    |          |  |       |    |          |                              |       |    |          |                               |       |    |          |                                      |       |    |          |                          |       |    |          |                             |       |    |          |                 |       |    |          |              |       |    |          |                                 |       |    |          |                         |       |    |          |                          |       |    |          |                          |       |    |          |                    |       |    |          |                        |       |    |          |                       |       |    |
| VM2640A0  | DRAIN PUMP PROTECTION                   | 1.000   | PC         |                                    |   |      |             |     |     |          |                    |       |    |          |                               |       |    |          |   |       |    |          |                          |       |    |          |            |       |    |          |                            |       |    |          |  |       |    |          |                    |       |    |          |  |       |    |          |  |       |    |          |  |       |    |          |                              |       |    |          |                               |       |    |          |                                      |       |    |          |                          |       |    |          |                             |       |    |          |                 |       |    |          |              |       |    |          |                                 |       |    |          |                         |       |    |          |                          |       |    |          |                          |       |    |          |                    |       |    |          |                        |       |    |          |                       |       |    |



| COMPONENT   |  |   | SPARE PART |  |   |                                     |             |     |     |          |                                     |         |    |          |                                     |       |    |          |                        |       |    |
|---|--|---|------------|--|---|-------------------------------------|-------------|-----|-----|----------|-------------------------------------|---------|----|----------|-------------------------------------|-------|----|----------|------------------------|-------|----|
| Code  | Description                            | Image   | Code       | Description                              | Kit components  |                                     |             |     |     |          |                                     |         |    |          |                                     |       |    |          |                        |       |    |
| VM2039A   | DRAIN BEND FIXING RING                 |    | KVL1026A   | DRAIN PIPE BEND KI                       | <table border="1"> <thead> <tr> <th>Code</th> <th>Description</th> <th>Qty</th> <th>UOM</th> </tr> </thead> <tbody> <tr> <td>GN1400A0</td> <td>U-TRAP SEAL</td> <td>1.000</td> <td>PC</td> </tr> <tr> <td>VL1026A0</td> <td>BEND FOR DRAIN PIPE</td> <td>1.000</td> <td>PC</td> </tr> <tr> <td>VM2039A0</td> <td>DRAIN BEND FIXING RING</td> <td>1.000</td> <td>PC</td> </tr> </tbody> </table> | Code                                | Description | Qty | UOM | GN1400A0 | U-TRAP SEAL                         | 1.000   | PC | VL1026A0 | BEND FOR DRAIN PIPE                 | 1.000 | PC | VM2039A0 | DRAIN BEND FIXING RING | 1.000 | PC |
|   |  |   |            |  | Code  | Description                         | Qty         | UOM |     |          |                                     |         |    |          |                                     |       |    |          |                        |       |    |
| GN1400A0  | U-TRAP SEAL                            | 1.000   | PC         |  |   |                                     |             |     |     |          |                                     |         |    |          |                                     |       |    |          |                        |       |    |
| VL1026A0  | BEND FOR DRAIN PIPE                    | 1.000   | PC         |  |   |                                     |             |     |     |          |                                     |         |    |          |                                     |       |    |          |                        |       |    |
| VM2039A0  | DRAIN BEND FIXING RING                 | 1.000   | PC         |  |   |                                     |             |     |     |          |                                     |         |    |          |                                     |       |    |          |                        |       |    |
| <table border="1"> <thead> <tr> <th>Code</th> <th>Description</th> <th>Qty</th> <th>UOM</th> </tr> </thead> <tbody> <tr> <td>EL1349A0</td> <td>CLIP TO FIX Ø10 mm CONNECTION JOINT</td> <td>10.000</td> <td>PC</td> </tr> </tbody> </table> | Code                                   | Description   | Qty        | UOM                                      | EL1349A0  | CLIP TO FIX Ø10 mm CONNECTION JOINT | 10.000      | PC  |     |          |                                     |         |    |          |                                     |       |    |          |                        |       |    |
| Code  | Description                            | Qty   | UOM        |  |   |                                     |             |     |     |          |                                     |         |    |          |                                     |       |    |          |                        |       |    |
| EL1349A0  | CLIP TO FIX Ø10 mm CONNECTION JOINT    | 10.000  | PC         |  |   |                                     |             |     |     |          |                                     |         |    |          |                                     |       |    |          |                        |       |    |
| EL1349A   | CLIP TO FIX Ø10 mm CONNECTION JOINT    |    | KEL1349A   | Ø10 FITTING LOCKING CLIPS 10 PCS KIT     | <table border="1"> <thead> <tr> <th>Code</th> <th>Description</th> <th>Qty</th> <th>UOM</th> </tr> </thead> <tbody> <tr> <td>EL1349A0</td> <td>CLIP TO FIX Ø10 mm CONNECTION JOINT</td> <td>10.000</td> <td>PC</td> </tr> </tbody> </table>   | Code                                | Description | Qty | UOM | EL1349A0 | CLIP TO FIX Ø10 mm CONNECTION JOINT | 10.000  | PC |          |                                     |       |    |          |                        |       |    |
| Code  | Description                            | Qty   | UOM        |  |   |                                     |             |     |     |          |                                     |         |    |          |                                     |       |    |          |                        |       |    |
| EL1349A0  | CLIP TO FIX Ø10 mm CONNECTION JOINT    | 10.000  | PC         |  |   |                                     |             |     |     |          |                                     |         |    |          |                                     |       |    |          |                        |       |    |
| RC1360A   | 10 - 10 JG ELBOW FITTING               |  | KRC1360A   | D10 - D10 JG ELBOW FITTING 10 PCS KIT    | <table border="1"> <thead> <tr> <th>Code</th> <th>Description</th> <th>Qty</th> <th>UOM</th> </tr> </thead> <tbody> <tr> <td>RC1360A0</td> <td>10 - 10 JG ELBOW FITTING</td> <td>10.000</td> <td>PC</td> </tr> </tbody> </table>  | Code                                | Description | Qty | UOM | RC1360A0 | 10 - 10 JG ELBOW FITTING            | 10.000  | PC |          |                                     |       |    |          |                        |       |    |
| Code  | Description                            | Qty   | UOM        |  |   |                                     |             |     |     |          |                                     |         |    |          |                                     |       |    |          |                        |       |    |
| RC1360A0  | 10 - 10 JG ELBOW FITTING               | 10.000  | PC         |  |   |                                     |             |     |     |          |                                     |         |    |          |                                     |       |    |          |                        |       |    |
| TB1099A   | TB3130A-D10 WATER CONNECTING PIPE      |  | KTB2599A   | Ø10 PET WATER PIPE TB2243A0 100M KIT     | <table border="1"> <thead> <tr> <th>Code</th> <th>Description</th> <th>Qty</th> <th>UOM</th> </tr> </thead> <tbody> <tr> <td>TB2243A0</td> <td>D10 PE TRANSPARENT PIPE</td> <td>100.000</td> <td>M</td> </tr> </tbody> </table>   | Code                                | Description | Qty | UOM | TB2243A0 | D10 PE TRANSPARENT PIPE             | 100.000 | M  |          |                                     |       |    |          |                        |       |    |
|   |  |   |            |  | Code  | Description                         | Qty         | UOM |     |          |                                     |         |    |          |                                     |       |    |          |                        |       |    |
| TB2243A0  | D10 PE TRANSPARENT PIPE                | 100.000   | M          |  |   |                                     |             |     |     |          |                                     |         |    |          |                                     |       |    |          |                        |       |    |
| <table border="1"> <thead> <tr> <th>Code</th> <th>Description</th> <th>Qty</th> <th>UOM</th> </tr> </thead> <tbody> <tr> <td>TB2243A0</td> <td>D10 PE TRANSPARENT PIPE</td> <td>3.000</td> <td>M</td> </tr> </tbody> </table>               | Code                                   | Description   | Qty        | UOM                                      | TB2243A0  | D10 PE TRANSPARENT PIPE             | 3.000       | M   |     |          |                                     |         |    |          |                                     |       |    |          |                        |       |    |
| Code  | Description                            | Qty   | UOM        |  |   |                                     |             |     |     |          |                                     |         |    |          |                                     |       |    |          |                        |       |    |
| TB2243A0  | D10 PE TRANSPARENT PIPE                | 3.000   | M          |  |   |                                     |             |     |     |          |                                     |         |    |          |                                     |       |    |          |                        |       |    |
| KTB2598A  | D10 PET HUMIDITY PIPE TB2243A0 3 M KIT |   |            |  | <table border="1"> <thead> <tr> <th>Code</th> <th>Description</th> <th>Qty</th> <th>UOM</th> </tr> </thead> <tbody> <tr> <td>TB2243A0</td> <td>D10 PE TRANSPARENT PIPE</td> <td>3.000</td> <td>M</td> </tr> </tbody> </table>   | Code                                | Description | Qty | UOM | TB2243A0 | D10 PE TRANSPARENT PIPE             | 3.000   | M  |          |                                     |       |    |          |                        |       |    |
| Code  | Description                            | Qty   | UOM        |  |   |                                     |             |     |     |          |                                     |         |    |          |                                     |       |    |          |                        |       |    |
| TB2243A0  | D10 PE TRANSPARENT PIPE                | 3.000   | M          |  |   |                                     |             |     |     |          |                                     |         |    |          |                                     |       |    |          |                        |       |    |
| VL1135A   | 3/4-JG10 CONNECTOR + FILTER AND NRV    |  | KVL1135A   | 3/4-JG10 FITTING WITH FILTER AND VNR KIT | <table border="1"> <thead> <tr> <th>Code</th> <th>Description</th> <th>Qty</th> <th>UOM</th> </tr> </thead> <tbody> <tr> <td>RC1360A0</td> <td>10 - 10 JG ELBOW FITTING</td> <td>1.000</td> <td>PC</td> </tr> <tr> <td>VL1135A1</td> <td>3/4-JG10 CONNECTOR + FILTER AND NRV</td> <td>1.000</td> <td>PC</td> </tr> </tbody> </table>  | Code                                | Description | Qty | UOM | RC1360A0 | 10 - 10 JG ELBOW FITTING            | 1.000   | PC | VL1135A1 | 3/4-JG10 CONNECTOR + FILTER AND NRV | 1.000 | PC |          |                        |       |    |
| Code  | Description                            | Qty   | UOM        |  |   |                                     |             |     |     |          |                                     |         |    |          |                                     |       |    |          |                        |       |    |
| RC1360A0  | 10 - 10 JG ELBOW FITTING               | 1.000   | PC         |  |   |                                     |             |     |     |          |                                     |         |    |          |                                     |       |    |          |                        |       |    |
| VL1135A1  | 3/4-JG10 CONNECTOR + FILTER AND NRV    | 1.000   | PC         |  |   |                                     |             |     |     |          |                                     |         |    |          |                                     |       |    |          |                        |       |    |

| COMPONENT |   |   | SPARE PART |  |  |      |             |     |     |          |   |        |    |
|-----------|---|---|------------|--|--|------|-------------|-----|-----|----------|---|--------|----|
| Code      | Description                                   | Image   | Code       | Description                                    | Kit components   |      |             |     |     |          |   |        |    |
| EL1195A   | ELBOW UNION<br>Ø8F-Ø8M                        |    | KEL1195A   | D8F-D8M JG ELBOW<br>FITTING 10 PCS KIT         | <table border="1"> <thead> <tr> <th>Code</th> <th>Description</th> <th>Qty</th> <th>UOM</th> </tr> </thead> <tbody> <tr> <td>EL1195A0</td> <td>ELBOW UNION<br/>Ø8F-Ø8M</td> <td>10.000</td> <td>PC</td> </tr> </tbody> </table>                          | Code | Description | Qty | UOM | EL1195A0 | ELBOW UNION<br>Ø8F-Ø8M                        | 10.000 | PC |
| Code      | Description                                   | Qty   | UOM        |  |  |      |             |     |     |          |   |        |    |
| EL1195A0  | ELBOW UNION<br>Ø8F-Ø8M                        | 10.000  | PC         |  |  |      |             |     |     |          |   |        |    |
| RC1002A   | JG 10M-8F<br>TERMINAL<br>REDUCTION FITTIN     |    | KRC1002A   | JG Ø10M-Ø8F<br>REDUCING SPIGOT<br>10 PCS KIT   | <table border="1"> <thead> <tr> <th>Code</th> <th>Description</th> <th>Qty</th> <th>UOM</th> </tr> </thead> <tbody> <tr> <td>RC1002A0</td> <td>JG 10M-8F<br/>TERMINAL<br/>REDUCTION<br/>FITTING</td> <td>10.000</td> <td>PC</td> </tr> </tbody> </table> | Code | Description | Qty | UOM | RC1002A0 | JG 10M-8F<br>TERMINAL<br>REDUCTION<br>FITTING | 10.000 | PC |
| Code      | Description                                   | Qty   | UOM        |  |  |      |             |     |     |          |   |        |    |
| RC1002A0  | JG 10M-8F<br>TERMINAL<br>REDUCTION<br>FITTING | 10.000  | PC         |  |  |      |             |     |     |          |   |        |    |
| TB2808A   | TB1815A0-D8 H2O<br>SOLENOID LUX 0,5M          |  | TB2808A0   | TB1815A0-D8 H2O<br>SOLENOID LUX 0,5M           |  |      |             |     |     |          |   |        |    |
| VM2028A   | 20x10x4 RUBBER<br>WASHER                      |  | KVM2028A   | 20x10x4 RUBBER<br>WASHER 5 PCS. KIT            | <table border="1"> <thead> <tr> <th>Code</th> <th>Description</th> <th>Qty</th> <th>UOM</th> </tr> </thead> <tbody> <tr> <td>VM2028A0</td> <td>20x10x4<br/>RUBBER<br/>WASHER</td> <td>5.000</td> <td>PC</td> </tr> </tbody> </table>                     | Code | Description | Qty | UOM | VM2028A0 | 20x10x4<br>RUBBER<br>WASHER                   | 5.000  | PC |
| Code      | Description                                   | Qty   | UOM        |  |  |      |             |     |     |          |   |        |    |
| VM2028A0  | 20x10x4<br>RUBBER<br>WASHER                   | 5.000   | PC         |  |  |      |             |     |     |          |   |        |    |
| GN1275A   | XBC/XVC BLACK<br>CHIMNEY SEALING              |  | KG1275A    | KIT GUARNIZIONE<br>CAMINO SILICONE<br>NERO 4PZ | <table border="1"> <thead> <tr> <th>Code</th> <th>Description</th> <th>Qty</th> <th>UOM</th> </tr> </thead> <tbody> <tr> <td>GN1275A0</td> <td>XBC/XVC<br/>BLACK<br/>CHIMNEY<br/>SEALING</td> <td>4.000</td> <td>PC</td> </tr> </tbody> </table>         | Code | Description | Qty | UOM | GN1275A0 | XBC/XVC<br>BLACK<br>CHIMNEY<br>SEALING        | 4.000  | PC |
| Code      | Description                                   | Qty   | UOM        |  |  |      |             |     |     |          |   |        |    |
| GN1275A0  | XBC/XVC<br>BLACK<br>CHIMNEY<br>SEALING        | 4.000   | PC         |  |  |      |             |     |     |          |   |        |    |



| COMPONENT |   |   | SPARE PART |  |  |      |             |     |     |          |   |        |    |          |                                |       |    |          |                              |       |    |          |                         |       |    |
|-----------|---|---|------------|--|--|------|-------------|-----|-----|----------|---|--------|----|----------|--------------------------------|-------|----|----------|------------------------------|-------|----|----------|-------------------------|-------|----|
| Code      | Description                             | Image   | Code       | Description                            | Kit components   |      |             |     |     |          |   |        |    |          |                                |       |    |          |                              |       |    |          |                         |       |    |
| VI1081A   | M6X25 STAINLESS STEEL SCREW             |    | KVI1081A   | 10PCS. M6x25 ST.STEEL SCREW KI         | <table border="1"> <thead> <tr> <th>Code</th> <th>Description</th> <th>Qty</th> <th>UOM</th> </tr> </thead> <tbody> <tr> <td>VI1081A0</td> <td>M6X25 STAINLESS STEEL SCREW</td> <td>10.000</td> <td>PC</td> </tr> </tbody> </table>  | Code | Description | Qty | UOM | VI1081A0 | M6X25 STAINLESS STEEL SCREW             | 10.000 | PC |          |                                |       |    |          |                              |       |    |          |                         |       |    |
| Code      | Description                             | Qty   | UOM        |  |  |      |             |     |     |          |   |        |    |          |                                |       |    |          |                              |       |    |          |                         |       |    |
| VI1081A0  | M6X25 STAINLESS STEEL SCREW             | 10.000  | PC         |  |  |      |             |     |     |          |   |        |    |          |                                |       |    |          |                              |       |    |          |                         |       |    |
| VM1165B   | CT BT DOOR UPPER BRACKET                |    | KVM1165B   | CT BT CL BL DOOR UPPER BRACKET KI      | <table border="1"> <thead> <tr> <th>Code</th> <th>Description</th> <th>Qty</th> <th>UOM</th> </tr> </thead> <tbody> <tr> <td>VM1165B0</td> <td>CT BT DOOR UPPER BRACKET</td> <td>1.000</td> <td>PC</td> </tr> </tbody> </table>  | Code | Description | Qty | UOM | VM1165B0 | CT BT DOOR UPPER BRACKET                | 1.000  | PC |          |                                |       |    |          |                              |       |    |          |                         |       |    |
| Code      | Description                             | Qty   | UOM        |  |  |      |             |     |     |          |   |        |    |          |                                |       |    |          |                              |       |    |          |                         |       |    |
| VM1165B0  | CT BT DOOR UPPER BRACKET                | 1.000   | PC         |  |  |      |             |     |     |          |   |        |    |          |                                |       |    |          |                              |       |    |          |                         |       |    |
| VM1166A   | CAP FOR DOOR UPPER STIRRUP XVC204/304/5 |  | KVM1166A   | DOOR UPPER BRACKET COVER KI            | <table border="1"> <thead> <tr> <th>Code</th> <th>Description</th> <th>Qty</th> <th>UOM</th> </tr> </thead> <tbody> <tr> <td>VM1166A0</td> <td>CAP FOR DOOR UPPER STIRRUP XVC204/304/5</td> <td>1.000</td> <td>PC</td> </tr> </tbody> </table>   | Code | Description | Qty | UOM | VM1166A0 | CAP FOR DOOR UPPER STIRRUP XVC204/304/5 | 1.000  | PC |          |                                |       |    |          |                              |       |    |          |                         |       |    |
| Code      | Description                             | Qty   | UOM        |  |  |      |             |     |     |          |   |        |    |          |                                |       |    |          |                              |       |    |          |                         |       |    |
| VM1166A0  | CAP FOR DOOR UPPER STIRRUP XVC204/304/5 | 1.000   | PC         |  |  |      |             |     |     |          |   |        |    |          |                                |       |    |          |                              |       |    |          |                         |       |    |
| VM1190A   | CT BT RIGHT DOOR SPRING LATCH           |  | KVM1190A   | CHEFTOP/BAKERTO P DOOR RIGHT LATCH KIT | <table border="1"> <thead> <tr> <th>Code</th> <th>Description</th> <th>Qty</th> <th>UOM</th> </tr> </thead> <tbody> <tr> <td>VI0239A1</td> <td>SELF-TAPPIN G SCREW 4.2X25 TCB+ INOX</td> <td>2.000</td> <td>PC</td> </tr> <tr> <td>VI1220A1</td> <td>4.2x12 TCB SELF-TAPPIN G SCREW</td> <td>2.000</td> <td>PC</td> </tr> <tr> <td>VM1460A0</td> <td>XBC/XVC RIGHT DOOR LATCH CAP</td> <td>1.000</td> <td>PC</td> </tr> <tr> <td>VP1530A0</td> <td>BT CT RIGHT HANDLE LATC</td> <td>1.000</td> <td>PC</td> </tr> </tbody> </table> | Code | Description | Qty | UOM | VI0239A1 | SELF-TAPPIN G SCREW 4.2X25 TCB+ INOX    | 2.000  | PC | VI1220A1 | 4.2x12 TCB SELF-TAPPIN G SCREW | 2.000 | PC | VM1460A0 | XBC/XVC RIGHT DOOR LATCH CAP | 1.000 | PC | VP1530A0 | BT CT RIGHT HANDLE LATC | 1.000 | PC |
| Code      | Description                             | Qty   | UOM        |  |  |      |             |     |     |          |   |        |    |          |                                |       |    |          |                              |       |    |          |                         |       |    |
| VI0239A1  | SELF-TAPPIN G SCREW 4.2X25 TCB+ INOX    | 2.000   | PC         |  |  |      |             |     |     |          |   |        |    |          |                                |       |    |          |                              |       |    |          |                         |       |    |
| VI1220A1  | 4.2x12 TCB SELF-TAPPIN G SCREW          | 2.000   | PC         |  |  |      |             |     |     |          |   |        |    |          |                                |       |    |          |                              |       |    |          |                         |       |    |
| VM1460A0  | XBC/XVC RIGHT DOOR LATCH CAP            | 1.000   | PC         |  |  |      |             |     |     |          |   |        |    |          |                                |       |    |          |                              |       |    |          |                         |       |    |
| VP1530A0  | BT CT RIGHT HANDLE LATC                 | 1.000   | PC         |  |  |      |             |     |     |          |   |        |    |          |                                |       |    |          |                              |       |    |          |                         |       |    |
| VM1191A   | CT BT LEFT DOOR SPRING LATCH            |  | KVM1191A   | CHEFTOP/BAKERTO P DOOR LEFT LATCH KIT  | <table border="1"> <thead> <tr> <th>Code</th> <th>Description</th> <th>Qty</th> <th>UOM</th> </tr> </thead> <tbody> <tr> <td>VI0239A1</td> <td>SELF-TAPPIN G SCREW 4.2X25 TCB+ INOX</td> <td>2.000</td> <td>PC</td> </tr> <tr> <td>VI1220A1</td> <td>4.2x12 TCB SELF-TAPPIN G SCREW</td> <td>2.000</td> <td>PC</td> </tr> <tr> <td>VM1460A0</td> <td>XBC/XVC RIGHT DOOR LATCH CAP</td> <td>1.000</td> <td>PC</td> </tr> <tr> <td>VP1531A0</td> <td>BT CT LEFT HANDLE LATC</td> <td>1.000</td> <td>PC</td> </tr> </tbody> </table>  | Code | Description | Qty | UOM | VI0239A1 | SELF-TAPPIN G SCREW 4.2X25 TCB+ INOX    | 2.000  | PC | VI1220A1 | 4.2x12 TCB SELF-TAPPIN G SCREW | 2.000 | PC | VM1460A0 | XBC/XVC RIGHT DOOR LATCH CAP | 1.000 | PC | VP1531A0 | BT CT LEFT HANDLE LATC  | 1.000 | PC |
| Code      | Description                             | Qty   | UOM        |  |  |      |             |     |     |          |   |        |    |          |                                |       |    |          |                              |       |    |          |                         |       |    |
| VI0239A1  | SELF-TAPPIN G SCREW 4.2X25 TCB+ INOX    | 2.000   | PC         |  |  |      |             |     |     |          |   |        |    |          |                                |       |    |          |                              |       |    |          |                         |       |    |
| VI1220A1  | 4.2x12 TCB SELF-TAPPIN G SCREW          | 2.000   | PC         |  |  |      |             |     |     |          |   |        |    |          |                                |       |    |          |                              |       |    |          |                         |       |    |
| VM1460A0  | XBC/XVC RIGHT DOOR LATCH CAP            | 1.000   | PC         |  |  |      |             |     |     |          |   |        |    |          |                                |       |    |          |                              |       |    |          |                         |       |    |
| VP1531A0  | BT CT LEFT HANDLE LATC                  | 1.000   | PC         |  |  |      |             |     |     |          |   |        |    |          |                                |       |    |          |                              |       |    |          |                         |       |    |



| COMPONENT |   |  | SPARE PART |   |   |      |             |   |       |          |   |                                      |       |          |                                      |                                    |       |          |                                    |                            |       |          |                           |       |    |
|-----------|---|--|------------|---|---|------|-------------|---|-------|----------|---|--------------------------------------|-------|----------|--------------------------------------|------------------------------------|-------|----------|------------------------------------|----------------------------|-------|----------|---------------------------|-------|----|
| Code      | Description                                   | Image  | Code       | Description                                   | Kit components  |      |             |   |       |          |   |                                      |       |          |                                      |                                    |       |          |                                    |                            |       |          |                           |       |    |
| VM1192A   | CT BT DOOR<br>SPRING LATCH<br>BACK COVER      |   | KVM1191A   | CHEFTOP/BAKERTO<br>P DOOR LEFT<br>LATCH KIT   | <table border="1"> <thead> <tr> <th>Code</th> <th>Description</th> <th>Qty</th> <th>UOM</th> </tr> </thead> <tbody> <tr> <td>VI0239A1</td> <td>SELF-TAPPIN<br/>G SCREW<br/>4.2X25 TCB+<br/>INOX</td> <td>2.000</td> <td>PC</td> </tr> <tr> <td>VI1220A1</td> <td>4.2x12 TCB<br/>SELF-TAPPIN<br/>G SCREW</td> <td>2.000</td> <td>PC</td> </tr> <tr> <td>VM1460A0</td> <td>XBC/XVC<br/>RIGHT DOOR<br/>LATCH CAP</td> <td>1.000</td> <td>PC</td> </tr> <tr> <td>VP1531A0</td> <td>BT CT LEFT<br/>HANDLE LATC</td> <td>1.000</td> <td>PC</td> </tr> </tbody> </table> | Code | Description | Qty   | UOM   | VI0239A1 | SELF-TAPPIN<br>G SCREW<br>4.2X25 TCB+<br>INOX | 2.000                                | PC    | VI1220A1 | 4.2x12 TCB<br>SELF-TAPPIN<br>G SCREW | 2.000                              | PC    | VM1460A0 | XBC/XVC<br>RIGHT DOOR<br>LATCH CAP | 1.000                      | PC    | VP1531A0 | BT CT LEFT<br>HANDLE LATC | 1.000 | PC |
|           |   |  | Code       | Description                                   | Qty   | UOM  |             |   |       |          |   |                                      |       |          |                                      |                                    |       |          |                                    |                            |       |          |                           |       |    |
| VI0239A1  | SELF-TAPPIN<br>G SCREW<br>4.2X25 TCB+<br>INOX | 2.000  | PC         |   |   |      |             |   |       |          |   |                                      |       |          |                                      |                                    |       |          |                                    |                            |       |          |                           |       |    |
| VI1220A1  | 4.2x12 TCB<br>SELF-TAPPIN<br>G SCREW          | 2.000  | PC         |   |   |      |             |   |       |          |   |                                      |       |          |                                      |                                    |       |          |                                    |                            |       |          |                           |       |    |
| VM1460A0  | XBC/XVC<br>RIGHT DOOR<br>LATCH CAP            | 1.000  | PC         |   |   |      |             |   |       |          |   |                                      |       |          |                                      |                                    |       |          |                                    |                            |       |          |                           |       |    |
| VP1531A0  | BT CT LEFT<br>HANDLE LATC                     | 1.000  | PC         |   |   |      |             |   |       |          |   |                                      |       |          |                                      |                                    |       |          |                                    |                            |       |          |                           |       |    |
| KVM1190A  | CHEFTOP/BAKERTO<br>P DOOR RIGHT<br>LATCH KIT  | <table border="1"> <thead> <tr> <th>Code</th> <th>Description</th> <th>Qty</th> <th>UOM</th> </tr> </thead> <tbody> <tr> <td>VI0239A1</td> <td>SELF-TAPPIN<br/>G SCREW<br/>4.2X25 TCB+<br/>INOX</td> <td>2.000</td> <td>PC</td> </tr> <tr> <td>VI1220A1</td> <td>4.2x12 TCB<br/>SELF-TAPPIN<br/>G SCREW</td> <td>2.000</td> <td>PC</td> </tr> <tr> <td>VM1460A0</td> <td>XBC/XVC<br/>RIGHT DOOR<br/>LATCH CAP</td> <td>1.000</td> <td>PC</td> </tr> <tr> <td>VP1530A0</td> <td>BT CT RIGHT<br/>HANDLE LATC</td> <td>1.000</td> <td>PC</td> </tr> </tbody> </table> | Code       | Description                                   | Qty   | UOM  | VI0239A1    | SELF-TAPPIN<br>G SCREW<br>4.2X25 TCB+<br>INOX | 2.000 | PC       | VI1220A1                                      | 4.2x12 TCB<br>SELF-TAPPIN<br>G SCREW | 2.000 | PC       | VM1460A0                             | XBC/XVC<br>RIGHT DOOR<br>LATCH CAP | 1.000 | PC       | VP1530A0                           | BT CT RIGHT<br>HANDLE LATC | 1.000 | PC       |                           |       |    |
| Code      | Description                                   | Qty  | UOM        |   |   |      |             |   |       |          |   |                                      |       |          |                                      |                                    |       |          |                                    |                            |       |          |                           |       |    |
| VI0239A1  | SELF-TAPPIN<br>G SCREW<br>4.2X25 TCB+<br>INOX | 2.000  | PC         |   |   |      |             |   |       |          |   |                                      |       |          |                                      |                                    |       |          |                                    |                            |       |          |                           |       |    |
| VI1220A1  | 4.2x12 TCB<br>SELF-TAPPIN<br>G SCREW          | 2.000  | PC         |   |   |      |             |   |       |          |   |                                      |       |          |                                      |                                    |       |          |                                    |                            |       |          |                           |       |    |
| VM1460A0  | XBC/XVC<br>RIGHT DOOR<br>LATCH CAP            | 1.000  | PC         |   |   |      |             |   |       |          |   |                                      |       |          |                                      |                                    |       |          |                                    |                            |       |          |                           |       |    |
| VP1530A0  | BT CT RIGHT<br>HANDLE LATC                    | 1.000  | PC         |   |   |      |             |   |       |          |   |                                      |       |          |                                      |                                    |       |          |                                    |                            |       |          |                           |       |    |
| VM1195A   | HOLES BLANKING<br>PLATE<br>XVC204/304/504/704 |   | VM1195A0   | HOLES BLANKING<br>PLATE<br>XVC204/304/504/704 |   |      |             |   |       |          |   |                                      |       |          |                                      |                                    |       |          |                                    |                            |       |          |                           |       |    |
| VM1240A   | NYLON SUPPORT<br>CAP                          |   | KVM1240A   | 4 PCS COUNTER<br>BRACKET SUPPORT<br>CAP KIT   | <table border="1"> <thead> <tr> <th>Code</th> <th>Description</th> <th>Qty</th> <th>UOM</th> </tr> </thead> <tbody> <tr> <td>VM1240A0</td> <td>NYLON<br/>SUPPORT CAP</td> <td>4.000</td> <td>PC</td> </tr> </tbody> </table>  | Code | Description | Qty   | UOM   | VM1240A0 | NYLON<br>SUPPORT CAP                          | 4.000                                | PC    |          |                                      |                                    |       |          |                                    |                            |       |          |                           |       |    |
| Code      | Description                                   | Qty  | UOM        |   |   |      |             |   |       |          |   |                                      |       |          |                                      |                                    |       |          |                                    |                            |       |          |                           |       |    |
| VM1240A0  | NYLON<br>SUPPORT CAP                          | 4.000  | PC         |   |   |      |             |   |       |          |   |                                      |       |          |                                      |                                    |       |          |                                    |                            |       |          |                           |       |    |



| COMPONENT |                                      |   | SPARE PART |                                   |  |      |             |     |     |          |                                      |       |    |          |                               |       |    |
|-----------|--------------------------------------|---|------------|-----------------------------------|--|------|-------------|-----|-----|----------|--------------------------------------|-------|----|----------|-------------------------------|-------|----|
| Code      | Description                          | Image   | Code       | Description                       | Kit components   |      |             |     |     |          |                                      |       |    |          |                               |       |    |
| VM1460A   | XBC/XVC RIGHT DOOR LATCH CAP         |    | KVM1460A   | XBC/XVC RIGHT DOOR LATCH CAP KIT  | <table border="1"> <thead> <tr> <th>Code</th> <th>Description</th> <th>Qty</th> <th>UOM</th> </tr> </thead> <tbody> <tr> <td>VI0239A1</td> <td>SELF-TAPPIN G SCREW 4.2X25 TCB+ INOX</td> <td>2.000</td> <td>PC</td> </tr> <tr> <td>VM1460A0</td> <td>XBC/XVC RIGHT DOOR LATCH CAP</td> <td>1.000</td> <td>PC</td> </tr> </tbody> </table>  | Code | Description | Qty | UOM | VI0239A1 | SELF-TAPPIN G SCREW 4.2X25 TCB+ INOX | 2.000 | PC | VM1460A0 | XBC/XVC RIGHT DOOR LATCH CAP  | 1.000 | PC |
| Code      | Description                          | Qty   | UOM        |                                   |  |      |             |     |     |          |                                      |       |    |          |                               |       |    |
| VI0239A1  | SELF-TAPPIN G SCREW 4.2X25 TCB+ INOX | 2.000   | PC         |                                   |  |      |             |     |     |          |                                      |       |    |          |                               |       |    |
| VM1460A0  | XBC/XVC RIGHT DOOR LATCH CAP         | 1.000   | PC         |                                   |  |      |             |     |     |          |                                      |       |    |          |                               |       |    |
| VM1461A   | XBC/XVC LEFT DOOR LATCH COVE         |   | KVM1461A   | XBC/XVC LEFT DOOR LATCH COVER KIT | <table border="1"> <thead> <tr> <th>Code</th> <th>Description</th> <th>Qty</th> <th>UOM</th> </tr> </thead> <tbody> <tr> <td>VI0239A1</td> <td>SELF-TAPPIN G SCREW 4.2X25 TCB+ INOX</td> <td>2.000</td> <td>PC</td> </tr> <tr> <td>VM1461A0</td> <td>XBC/XVC LEFT DOOR LATCH COVER</td> <td>1.000</td> <td>PC</td> </tr> </tbody> </table> | Code | Description | Qty | UOM | VI0239A1 | SELF-TAPPIN G SCREW 4.2X25 TCB+ INOX | 2.000 | PC | VM1461A0 | XBC/XVC LEFT DOOR LATCH COVER | 1.000 | PC |
| Code      | Description                          | Qty   | UOM        |                                   |  |      |             |     |     |          |                                      |       |    |          |                               |       |    |
| VI0239A1  | SELF-TAPPIN G SCREW 4.2X25 TCB+ INOX | 2.000   | PC         |                                   |  |      |             |     |     |          |                                      |       |    |          |                               |       |    |
| VM1461A0  | XBC/XVC LEFT DOOR LATCH COVER        | 1.000   | PC         |                                   |  |      |             |     |     |          |                                      |       |    |          |                               |       |    |
| VM1974A   | CONTROL PANEL CLOSING PLATE          |  | VM1974A0   | CONTROL PANEL CLOSING PLATE       |  |      |             |     |     |          |                                      |       |    |          |                               |       |    |
| VM1975A   | DOOR SUPPORT LOWER BRACKET           |  | VM1975A0   | DOOR SUPPORT LOWER BRACKET        |  |      |             |     |     |          |                                      |       |    |          |                               |       |    |
| VM2035A   | DRAIN PIPE SUPPORT                   |  | KVM2035A   | DRAIN PIPE SUPPORT 2 PCS. KI      | <table border="1"> <thead> <tr> <th>Code</th> <th>Description</th> <th>Qty</th> <th>UOM</th> </tr> </thead> <tbody> <tr> <td>VM2035A0</td> <td>DRAIN PIPE SUPPORT</td> <td>2.000</td> <td>PC</td> </tr> </tbody> </table>  | Code | Description | Qty | UOM | VM2035A0 | DRAIN PIPE SUPPORT                   | 2.000 | PC |          |                               |       |    |
| Code      | Description                          | Qty   | UOM        |                                   |  |      |             |     |     |          |                                      |       |    |          |                               |       |    |
| VM2035A0  | DRAIN PIPE SUPPORT                   | 2.000   | PC         |                                   |  |      |             |     |     |          |                                      |       |    |          |                               |       |    |



**ASM4079A/0.D02 - Door - FRONT**





**ASM4079A/0.D02 - Door - REAR**



| COMPONENT |   |   | SPARE PART |   |  |      |             |     |     |          |                            |       |    |          |                            |       |    |          |                                     |       |    |          |                                |       |    |          |                        |       |    |          |                                     |       |    |          |   |       |    |          |                      |       |    |          |                                       |       |    |          |                             |       |    |
|-----------|---|---|------------|---|--|------|-------------|-----|-----|----------|----------------------------|-------|----|----------|----------------------------|-------|----|----------|-------------------------------------|-------|----|----------|--------------------------------|-------|----|----------|------------------------|-------|----|----------|-------------------------------------|-------|----|----------|---|-------|----|----------|----------------------|-------|----|----------|---------------------------------------|-------|----|----------|-----------------------------|-------|----|
| Code      | Description                               | Image   | Code       | Description                             | Kit components   |      |             |     |     |          |                            |       |    |          |                            |       |    |          |                                     |       |    |          |                                |       |    |          |                        |       |    |          |                                     |       |    |          |   |       |    |          |                      |       |    |          |                                       |       |    |          |                             |       |    |
| VM2008A   | SPACER FOR MICROSWITCH                    |  | KVM2008A   | MICROSWITCH SPACER KIT                  | <table border="1"> <thead> <tr> <th>Code</th> <th>Description</th> <th>Qty</th> <th>UOM</th> </tr> </thead> <tbody> <tr> <td>VM2008A0</td> <td>SPACER FOR MICROSWITC</td> <td>2.000</td> <td>PC</td> </tr> </tbody> </table>   | Code | Description | Qty | UOM | VM2008A0 | SPACER FOR MICROSWITC      | 2.000 | PC |          |                            |       |    |          |                                     |       |    |          |                                |       |    |          |                        |       |    |          |                                     |       |    |          |   |       |    |          |                      |       |    |          |                                       |       |    |          |                             |       |    |
| Code      | Description                               | Qty   | UOM        |   |  |      |             |     |     |          |                            |       |    |          |                            |       |    |          |                                     |       |    |          |                                |       |    |          |                        |       |    |          |                                     |       |    |          |   |       |    |          |                      |       |    |          |                                       |       |    |          |                             |       |    |
| VM2008A0  | SPACER FOR MICROSWITC                     | 2.000   | PC         |   |  |      |             |     |     |          |                            |       |    |          |                            |       |    |          |                                     |       |    |          |                                |       |    |          |                        |       |    |          |                                     |       |    |          |   |       |    |          |                      |       |    |          |                                       |       |    |          |                             |       |    |
| CR1085A   | INTERNAL GLASS UPPER HINGE                |  | KVM0012A   | 4-5-5E S. INT. GLASS OPENING SYSTEM KIT | <table border="1"> <thead> <tr> <th>Code</th> <th>Description</th> <th>Qty</th> <th>UOM</th> </tr> </thead> <tbody> <tr> <td>CR1085A0</td> <td>INTERNAL GLASS UPPER HINGE</td> <td>1.000</td> <td>PC</td> </tr> <tr> <td>CR1086A0</td> <td>INTERNAL GLASS LOWER HINGE</td> <td>1.000</td> <td>PC</td> </tr> <tr> <td>GN1181A0</td> <td>INTERNAL GLASS HINGE SEAL</td> <td>2.000</td> <td>PC</td> </tr> <tr> <td>VI1220A1</td> <td>4,2x12 TCB SELF-TAPPIN G SCREW</td> <td>5.000</td> <td>PC</td> </tr> <tr> <td>VI1300A0</td> <td>SCREW M6X12 T1/2T+INOX</td> <td>4.000</td> <td>PC</td> </tr> <tr> <td>VI1810A0</td> <td>M6X6 STAINLESS STEEL FLATHEAD SCREW</td> <td>6.000</td> <td>PC</td> </tr> <tr> <td>VI1950A0</td> <td>ST. STEEL 4,2X13 TCB SELF-DRILLIN G SCREW</td> <td>6.000</td> <td>PC</td> </tr> <tr> <td>VM1680A0</td> <td>INTERNAL GLASS HINGE</td> <td>2.000</td> <td>PC</td> </tr> <tr> <td>VM2042A0</td> <td>INTERNAL GLASS LATERAL LOCKING SYSTEM</td> <td>2.000</td> <td>PC</td> </tr> <tr> <td>VM2043A0</td> <td>UPPER - LOWER GLASS SUPPORT</td> <td>2.000</td> <td>PC</td> </tr> </tbody> </table> | Code | Description | Qty | UOM | CR1085A0 | INTERNAL GLASS UPPER HINGE | 1.000 | PC | CR1086A0 | INTERNAL GLASS LOWER HINGE | 1.000 | PC | GN1181A0 | INTERNAL GLASS HINGE SEAL           | 2.000 | PC | VI1220A1 | 4,2x12 TCB SELF-TAPPIN G SCREW | 5.000 | PC | VI1300A0 | SCREW M6X12 T1/2T+INOX | 4.000 | PC | VI1810A0 | M6X6 STAINLESS STEEL FLATHEAD SCREW | 6.000 | PC | VI1950A0 | ST. STEEL 4,2X13 TCB SELF-DRILLIN G SCREW | 6.000 | PC | VM1680A0 | INTERNAL GLASS HINGE | 2.000 | PC | VM2042A0 | INTERNAL GLASS LATERAL LOCKING SYSTEM | 2.000 | PC | VM2043A0 | UPPER - LOWER GLASS SUPPORT | 2.000 | PC |
| Code      | Description                               | Qty   | UOM        |   |  |      |             |     |     |          |                            |       |    |          |                            |       |    |          |                                     |       |    |          |                                |       |    |          |                        |       |    |          |                                     |       |    |          |   |       |    |          |                      |       |    |          |                                       |       |    |          |                             |       |    |
| CR1085A0  | INTERNAL GLASS UPPER HINGE                | 1.000   | PC         |   |  |      |             |     |     |          |                            |       |    |          |                            |       |    |          |                                     |       |    |          |                                |       |    |          |                        |       |    |          |                                     |       |    |          |   |       |    |          |                      |       |    |          |                                       |       |    |          |                             |       |    |
| CR1086A0  | INTERNAL GLASS LOWER HINGE                | 1.000   | PC         |   |  |      |             |     |     |          |                            |       |    |          |                            |       |    |          |                                     |       |    |          |                                |       |    |          |                        |       |    |          |                                     |       |    |          |   |       |    |          |                      |       |    |          |                                       |       |    |          |                             |       |    |
| GN1181A0  | INTERNAL GLASS HINGE SEAL                 | 2.000   | PC         |   |  |      |             |     |     |          |                            |       |    |          |                            |       |    |          |                                     |       |    |          |                                |       |    |          |                        |       |    |          |                                     |       |    |          |   |       |    |          |                      |       |    |          |                                       |       |    |          |                             |       |    |
| VI1220A1  | 4,2x12 TCB SELF-TAPPIN G SCREW            | 5.000   | PC         |   |  |      |             |     |     |          |                            |       |    |          |                            |       |    |          |                                     |       |    |          |                                |       |    |          |                        |       |    |          |                                     |       |    |          |   |       |    |          |                      |       |    |          |                                       |       |    |          |                             |       |    |
| VI1300A0  | SCREW M6X12 T1/2T+INOX                    | 4.000   | PC         |   |  |      |             |     |     |          |                            |       |    |          |                            |       |    |          |                                     |       |    |          |                                |       |    |          |                        |       |    |          |                                     |       |    |          |   |       |    |          |                      |       |    |          |                                       |       |    |          |                             |       |    |
| VI1810A0  | M6X6 STAINLESS STEEL FLATHEAD SCREW       | 6.000   | PC         |   |  |      |             |     |     |          |                            |       |    |          |                            |       |    |          |                                     |       |    |          |                                |       |    |          |                        |       |    |          |                                     |       |    |          |   |       |    |          |                      |       |    |          |                                       |       |    |          |                             |       |    |
| VI1950A0  | ST. STEEL 4,2X13 TCB SELF-DRILLIN G SCREW | 6.000   | PC         |   |  |      |             |     |     |          |                            |       |    |          |                            |       |    |          |                                     |       |    |          |                                |       |    |          |                        |       |    |          |                                     |       |    |          |   |       |    |          |                      |       |    |          |                                       |       |    |          |                             |       |    |
| VM1680A0  | INTERNAL GLASS HINGE                      | 2.000   | PC         |   |  |      |             |     |     |          |                            |       |    |          |                            |       |    |          |                                     |       |    |          |                                |       |    |          |                        |       |    |          |                                     |       |    |          |   |       |    |          |                      |       |    |          |                                       |       |    |          |                             |       |    |
| VM2042A0  | INTERNAL GLASS LATERAL LOCKING SYSTEM     | 2.000   | PC         |   |  |      |             |     |     |          |                            |       |    |          |                            |       |    |          |                                     |       |    |          |                                |       |    |          |                        |       |    |          |                                     |       |    |          |   |       |    |          |                      |       |    |          |                                       |       |    |          |                             |       |    |
| VM2043A0  | UPPER - LOWER GLASS SUPPORT               | 2.000   | PC         |   |  |      |             |     |     |          |                            |       |    |          |                            |       |    |          |                                     |       |    |          |                                |       |    |          |                        |       |    |          |                                     |       |    |          |   |       |    |          |                      |       |    |          |                                       |       |    |          |                             |       |    |
|           |   |   | KCR1085A   | INTERNAL GLASS UPPER HINGE KIT          | <table border="1"> <thead> <tr> <th>Code</th> <th>Description</th> <th>Qty</th> <th>UOM</th> </tr> </thead> <tbody> <tr> <td>CR1085A0</td> <td>INTERNAL GLASS UPPER HINGE</td> <td>1.000</td> <td>PC</td> </tr> <tr> <td>GN1181A0</td> <td>INTERNAL GLASS HINGE SEAL</td> <td>1.000</td> <td>PC</td> </tr> <tr> <td>VI1810A0</td> <td>M6X6 STAINLESS STEEL FLATHEAD SCREW</td> <td>3.000</td> <td>PC</td> </tr> </tbody> </table>  | Code | Description | Qty | UOM | CR1085A0 | INTERNAL GLASS UPPER HINGE | 1.000 | PC | GN1181A0 | INTERNAL GLASS HINGE SEAL  | 1.000 | PC | VI1810A0 | M6X6 STAINLESS STEEL FLATHEAD SCREW | 3.000 | PC |          |                                |       |    |          |                        |       |    |          |                                     |       |    |          |   |       |    |          |                      |       |    |          |                                       |       |    |          |                             |       |    |
| Code      | Description                               | Qty   | UOM        |   |  |      |             |     |     |          |                            |       |    |          |                            |       |    |          |                                     |       |    |          |                                |       |    |          |                        |       |    |          |                                     |       |    |          |   |       |    |          |                      |       |    |          |                                       |       |    |          |                             |       |    |
| CR1085A0  | INTERNAL GLASS UPPER HINGE                | 1.000   | PC         |   |  |      |             |     |     |          |                            |       |    |          |                            |       |    |          |                                     |       |    |          |                                |       |    |          |                        |       |    |          |                                     |       |    |          |   |       |    |          |                      |       |    |          |                                       |       |    |          |                             |       |    |
| GN1181A0  | INTERNAL GLASS HINGE SEAL                 | 1.000   | PC         |   |  |      |             |     |     |          |                            |       |    |          |                            |       |    |          |                                     |       |    |          |                                |       |    |          |                        |       |    |          |                                     |       |    |          |   |       |    |          |                      |       |    |          |                                       |       |    |          |                             |       |    |
| VI1810A0  | M6X6 STAINLESS STEEL FLATHEAD SCREW       | 3.000   | PC         |   |  |      |             |     |     |          |                            |       |    |          |                            |       |    |          |                                     |       |    |          |                                |       |    |          |                        |       |    |          |                                     |       |    |          |   |       |    |          |                      |       |    |          |                                       |       |    |          |                             |       |    |



| COMPONENT |  |   | SPARE PART |   |  |      |             |     |     |          |                            |       |    |          |                            |       |    |          |                                     |       |    |          |                               |       |    |          |                        |       |    |          |                                     |       |    |          |  |       |    |          |                      |       |    |          |                                       |       |    |          |                             |       |    |
|-----------|--|---|------------|---|--|------|-------------|-----|-----|----------|----------------------------|-------|----|----------|----------------------------|-------|----|----------|-------------------------------------|-------|----|----------|-------------------------------|-------|----|----------|------------------------|-------|----|----------|-------------------------------------|-------|----|----------|--|-------|----|----------|----------------------|-------|----|----------|---------------------------------------|-------|----|----------|-----------------------------|-------|----|
| Code      | Description                              | Image   | Code       | Description                             | Kit components   |      |             |     |     |          |                            |       |    |          |                            |       |    |          |                                     |       |    |          |                               |       |    |          |                        |       |    |          |                                     |       |    |          |  |       |    |          |                      |       |    |          |                                       |       |    |          |                             |       |    |
| GN1181A   | INTERNAL GLASS HINGE SEAL                |  | KGN1181A   | INT. GLASS HINGE GASKET 2 PCS KIT       | <table border="1"> <thead> <tr> <th>Code</th> <th>Description</th> <th>Qty</th> <th>UOM</th> </tr> </thead> <tbody> <tr> <td>GN1181A0</td> <td>INTERNAL GLASS HINGE SEAL</td> <td>2.000</td> <td>PC</td> </tr> </tbody> </table>   | Code | Description | Qty | UOM | GN1181A0 | INTERNAL GLASS HINGE SEAL  | 2.000 | PC |          |                            |       |    |          |                                     |       |    |          |                               |       |    |          |                        |       |    |          |                                     |       |    |          |  |       |    |          |                      |       |    |          |                                       |       |    |          |                             |       |    |
| Code      | Description                              | Qty   | UOM        |   |  |      |             |     |     |          |                            |       |    |          |                            |       |    |          |                                     |       |    |          |                               |       |    |          |                        |       |    |          |                                     |       |    |          |  |       |    |          |                      |       |    |          |                                       |       |    |          |                             |       |    |
| GN1181A0  | INTERNAL GLASS HINGE SEAL                | 2.000   | PC         |   |  |      |             |     |     |          |                            |       |    |          |                            |       |    |          |                                     |       |    |          |                               |       |    |          |                        |       |    |          |                                     |       |    |          |  |       |    |          |                      |       |    |          |                                       |       |    |          |                             |       |    |
| CR1086A   | INTERNAL GLASS LOWER HINGE               |  | KVM0012A   | 4-5-5E S. INT. GLASS OPENING SYSTEM KIT | <table border="1"> <thead> <tr> <th>Code</th> <th>Description</th> <th>Qty</th> <th>UOM</th> </tr> </thead> <tbody> <tr> <td>CR1085A0</td> <td>INTERNAL GLASS UPPER HINGE</td> <td>1.000</td> <td>PC</td> </tr> <tr> <td>CR1086A0</td> <td>INTERNAL GLASS LOWER HINGE</td> <td>1.000</td> <td>PC</td> </tr> <tr> <td>GN1181A0</td> <td>INTERNAL GLASS HINGE SEAL</td> <td>2.000</td> <td>PC</td> </tr> <tr> <td>VI1220A1</td> <td>4,2x12 TCB SELF-TAPPING SCREW</td> <td>5.000</td> <td>PC</td> </tr> <tr> <td>VI1300A0</td> <td>SCREW M6X12 T1/2T+INOX</td> <td>4.000</td> <td>PC</td> </tr> <tr> <td>VI1810A0</td> <td>M6X6 STAINLESS STEEL FLATHEAD SCREW</td> <td>6.000</td> <td>PC</td> </tr> <tr> <td>VI1950A0</td> <td>ST. STEEL 4,2X13 TCB SELF-DRILLING SCREW</td> <td>6.000</td> <td>PC</td> </tr> <tr> <td>VM1680A0</td> <td>INTERNAL GLASS HINGE</td> <td>2.000</td> <td>PC</td> </tr> <tr> <td>VM2042A0</td> <td>INTERNAL GLASS LATERAL LOCKING SYSTEM</td> <td>2.000</td> <td>PC</td> </tr> <tr> <td>VM2043A0</td> <td>UPPER - LOWER GLASS SUPPORT</td> <td>2.000</td> <td>PC</td> </tr> </tbody> </table> | Code | Description | Qty | UOM | CR1085A0 | INTERNAL GLASS UPPER HINGE | 1.000 | PC | CR1086A0 | INTERNAL GLASS LOWER HINGE | 1.000 | PC | GN1181A0 | INTERNAL GLASS HINGE SEAL           | 2.000 | PC | VI1220A1 | 4,2x12 TCB SELF-TAPPING SCREW | 5.000 | PC | VI1300A0 | SCREW M6X12 T1/2T+INOX | 4.000 | PC | VI1810A0 | M6X6 STAINLESS STEEL FLATHEAD SCREW | 6.000 | PC | VI1950A0 | ST. STEEL 4,2X13 TCB SELF-DRILLING SCREW | 6.000 | PC | VM1680A0 | INTERNAL GLASS HINGE | 2.000 | PC | VM2042A0 | INTERNAL GLASS LATERAL LOCKING SYSTEM | 2.000 | PC | VM2043A0 | UPPER - LOWER GLASS SUPPORT | 2.000 | PC |
| Code      | Description                              | Qty   | UOM        |   |  |      |             |     |     |          |                            |       |    |          |                            |       |    |          |                                     |       |    |          |                               |       |    |          |                        |       |    |          |                                     |       |    |          |  |       |    |          |                      |       |    |          |                                       |       |    |          |                             |       |    |
| CR1085A0  | INTERNAL GLASS UPPER HINGE               | 1.000   | PC         |   |  |      |             |     |     |          |                            |       |    |          |                            |       |    |          |                                     |       |    |          |                               |       |    |          |                        |       |    |          |                                     |       |    |          |  |       |    |          |                      |       |    |          |                                       |       |    |          |                             |       |    |
| CR1086A0  | INTERNAL GLASS LOWER HINGE               | 1.000   | PC         |   |  |      |             |     |     |          |                            |       |    |          |                            |       |    |          |                                     |       |    |          |                               |       |    |          |                        |       |    |          |                                     |       |    |          |  |       |    |          |                      |       |    |          |                                       |       |    |          |                             |       |    |
| GN1181A0  | INTERNAL GLASS HINGE SEAL                | 2.000   | PC         |   |  |      |             |     |     |          |                            |       |    |          |                            |       |    |          |                                     |       |    |          |                               |       |    |          |                        |       |    |          |                                     |       |    |          |  |       |    |          |                      |       |    |          |                                       |       |    |          |                             |       |    |
| VI1220A1  | 4,2x12 TCB SELF-TAPPING SCREW            | 5.000   | PC         |   |  |      |             |     |     |          |                            |       |    |          |                            |       |    |          |                                     |       |    |          |                               |       |    |          |                        |       |    |          |                                     |       |    |          |  |       |    |          |                      |       |    |          |                                       |       |    |          |                             |       |    |
| VI1300A0  | SCREW M6X12 T1/2T+INOX                   | 4.000   | PC         |   |  |      |             |     |     |          |                            |       |    |          |                            |       |    |          |                                     |       |    |          |                               |       |    |          |                        |       |    |          |                                     |       |    |          |  |       |    |          |                      |       |    |          |                                       |       |    |          |                             |       |    |
| VI1810A0  | M6X6 STAINLESS STEEL FLATHEAD SCREW      | 6.000   | PC         |   |  |      |             |     |     |          |                            |       |    |          |                            |       |    |          |                                     |       |    |          |                               |       |    |          |                        |       |    |          |                                     |       |    |          |  |       |    |          |                      |       |    |          |                                       |       |    |          |                             |       |    |
| VI1950A0  | ST. STEEL 4,2X13 TCB SELF-DRILLING SCREW | 6.000   | PC         |   |  |      |             |     |     |          |                            |       |    |          |                            |       |    |          |                                     |       |    |          |                               |       |    |          |                        |       |    |          |                                     |       |    |          |  |       |    |          |                      |       |    |          |                                       |       |    |          |                             |       |    |
| VM1680A0  | INTERNAL GLASS HINGE                     | 2.000   | PC         |   |  |      |             |     |     |          |                            |       |    |          |                            |       |    |          |                                     |       |    |          |                               |       |    |          |                        |       |    |          |                                     |       |    |          |  |       |    |          |                      |       |    |          |                                       |       |    |          |                             |       |    |
| VM2042A0  | INTERNAL GLASS LATERAL LOCKING SYSTEM    | 2.000   | PC         |   |  |      |             |     |     |          |                            |       |    |          |                            |       |    |          |                                     |       |    |          |                               |       |    |          |                        |       |    |          |                                     |       |    |          |  |       |    |          |                      |       |    |          |                                       |       |    |          |                             |       |    |
| VM2043A0  | UPPER - LOWER GLASS SUPPORT              | 2.000   | PC         |   |  |      |             |     |     |          |                            |       |    |          |                            |       |    |          |                                     |       |    |          |                               |       |    |          |                        |       |    |          |                                     |       |    |          |  |       |    |          |                      |       |    |          |                                       |       |    |          |                             |       |    |
|           |  |   | KCR1086A   | INTERNAL GLASS LOWER HINGE KIT          | <table border="1"> <thead> <tr> <th>Code</th> <th>Description</th> <th>Qty</th> <th>UOM</th> </tr> </thead> <tbody> <tr> <td>CR1086A0</td> <td>INTERNAL GLASS LOWER HINGE</td> <td>1.000</td> <td>PC</td> </tr> <tr> <td>GN1181A0</td> <td>INTERNAL GLASS HINGE SEAL</td> <td>1.000</td> <td>PC</td> </tr> <tr> <td>VI1810A0</td> <td>M6X6 STAINLESS STEEL FLATHEAD SCREW</td> <td>3.000</td> <td>PC</td> </tr> </tbody> </table>  | Code | Description | Qty | UOM | CR1086A0 | INTERNAL GLASS LOWER HINGE | 1.000 | PC | GN1181A0 | INTERNAL GLASS HINGE SEAL  | 1.000 | PC | VI1810A0 | M6X6 STAINLESS STEEL FLATHEAD SCREW | 3.000 | PC |          |                               |       |    |          |                        |       |    |          |                                     |       |    |          |  |       |    |          |                      |       |    |          |                                       |       |    |          |                             |       |    |
| Code      | Description                              | Qty   | UOM        |   |  |      |             |     |     |          |                            |       |    |          |                            |       |    |          |                                     |       |    |          |                               |       |    |          |                        |       |    |          |                                     |       |    |          |  |       |    |          |                      |       |    |          |                                       |       |    |          |                             |       |    |
| CR1086A0  | INTERNAL GLASS LOWER HINGE               | 1.000   | PC         |   |  |      |             |     |     |          |                            |       |    |          |                            |       |    |          |                                     |       |    |          |                               |       |    |          |                        |       |    |          |                                     |       |    |          |  |       |    |          |                      |       |    |          |                                       |       |    |          |                             |       |    |
| GN1181A0  | INTERNAL GLASS HINGE SEAL                | 1.000   | PC         |   |  |      |             |     |     |          |                            |       |    |          |                            |       |    |          |                                     |       |    |          |                               |       |    |          |                        |       |    |          |                                     |       |    |          |  |       |    |          |                      |       |    |          |                                       |       |    |          |                             |       |    |
| VI1810A0  | M6X6 STAINLESS STEEL FLATHEAD SCREW      | 3.000   | PC         |   |  |      |             |     |     |          |                            |       |    |          |                            |       |    |          |                                     |       |    |          |                               |       |    |          |                        |       |    |          |                                     |       |    |          |  |       |    |          |                      |       |    |          |                                       |       |    |          |                             |       |    |

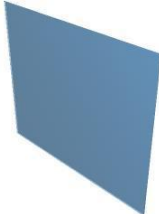

| COMPONENT |  |   | SPARE PART               |   |  |      |             |     |     |          |                                 |       |    |      |             |     |     |          |   |       |    |          |  |       |    |          |   |       |    |          |  |       |    |          |  |       |    |          |  |       |    |          |   |       |    |          |  |       |    |          |                                  |       |    |
|-----------|--|---|--------------------------|---|--|------|-------------|-----|-----|----------|---------------------------------|-------|----|------|-------------|-----|-----|----------|---|-------|----|----------|--|-------|----|----------|---|-------|----|----------|--|-------|----|----------|--|-------|----|----------|--|-------|----|----------|---|-------|----|----------|--|-------|----|----------|----------------------------------|-------|----|
| Code      | Description  | Image   | Code                     | Description   | Kit components   |      |             |     |     |          |                                 |       |    |      |             |     |     |          |   |       |    |          |  |       |    |          |   |       |    |          |  |       |    |          |  |       |    |          |  |       |    |          |   |       |    |          |  |       |    |          |                                  |       |    |
| GN1181A   | INTERNAL GLASS<br>HINGE SEAL                       |  | KG1181A                  | INT. GLASS HINGE<br>GASKET 2 PCS KIT  | <table border="1"> <thead> <tr> <th>Code</th> <th>Description</th> <th>Qty</th> <th>UOM</th> </tr> </thead> <tbody> <tr> <td>GN1181A0</td> <td>INTERNAL<br/>GLASS HINGE<br/>SEAL</td> <td>2.000</td> <td>PC</td> </tr> </tbody> </table>   | Code | Description | Qty | UOM | GN1181A0 | INTERNAL<br>GLASS HINGE<br>SEAL | 2.000 | PC |      |             |     |     |          |   |       |    |          |  |       |    |          |   |       |    |          |  |       |    |          |  |       |    |          |  |       |    |          |   |       |    |          |  |       |    |          |                                  |       |    |
| Code      | Description  | Qty   | UOM                      |   |  |      |             |     |     |          |                                 |       |    |      |             |     |     |          |   |       |    |          |  |       |    |          |   |       |    |          |  |       |    |          |  |       |    |          |  |       |    |          |   |       |    |          |  |       |    |          |                                  |       |    |
| GN1181A0  | INTERNAL<br>GLASS HINGE<br>SEAL                    | 2.000   | PC                       |   |  |      |             |     |     |          |                                 |       |    |      |             |     |     |          |   |       |    |          |  |       |    |          |   |       |    |          |  |       |    |          |  |       |    |          |  |       |    |          |   |       |    |          |  |       |    |          |                                  |       |    |
| VT1135A   | 743x620x6 INNER<br>GLASS                           |  | KVT1135A<br><br>KDR1136B | XB693/5 XBC605<br>XVC1205 INT.<br>GLASS KIT<br>XBC605/XVC1205P<br>COMPLETE DOOR | <table border="1"> <thead> <tr> <th>Code</th> <th>Description</th> <th>Qty</th> <th>UOM</th> </tr> </thead> <tbody> <tr> <td>VT1135A0</td> <td>743x620x6<br/>INNER GLASS</td> <td>1.000</td> <td>PC</td> </tr> </tbody> </table> <table border="1"> <thead> <tr> <th>Code</th> <th>Description</th> <th>Qty</th> <th>UOM</th> </tr> </thead> <tbody> <tr> <td>0H2650A0</td> <td>XBC/XVC ST.<br/>STEEL<br/>INTERNAL<br/>GLASS HINGE</td> <td>2.000</td> <td>PC</td> </tr> <tr> <td>0H2655A1</td> <td>STAINL.<br/>STEEL DRIP<br/>DRAIN TUBE<br/>INT-D-6</td> <td>1.000</td> <td>PC</td> </tr> <tr> <td>0H4277A0</td> <td>XVC505<br/>EXTERNAL<br/>GLASS<br/>HOLDING<br/>PROFILE</td> <td>2.000</td> <td>PC</td> </tr> <tr> <td>0H4310A0</td> <td>ST. STEEL<br/>HEAT-GUARD<br/>FOR<br/>CONTROL<br/>PANEL</td> <td>1.000</td> <td>PC</td> </tr> <tr> <td>CE1275A0</td> <td>3M POWER -<br/>CONTROL<br/>CONNECTION<br/>CABLE</td> <td>1.000</td> <td>PC</td> </tr> <tr> <td>CE1285A0</td> <td>EMI ROUND<br/>FERRITE<br/>MOD.26438015<br/>02</td> <td>2.000</td> <td>PC</td> </tr> <tr> <td>CE1290A0</td> <td>EXTRACTABL<br/>E FEMALE<br/>TERMINAL<br/>CPF 5/4</td> <td>2.000</td> <td>PC</td> </tr> <tr> <td>CE1310A1</td> <td>POWER -<br/>CONTROL<br/>BOARD<br/>CONNECTING<br/>CABLE</td> <td>1.000</td> <td>PC</td> </tr> <tr> <td>CE1665A0</td> <td>LED POWER<br/>SUPPLY 1 M<br/>CABLE</td> <td>1.000</td> <td>PC</td> </tr> </tbody> </table> | Code | Description | Qty | UOM | VT1135A0 | 743x620x6<br>INNER GLASS        | 1.000 | PC | Code | Description | Qty | UOM | 0H2650A0 | XBC/XVC ST.<br>STEEL<br>INTERNAL<br>GLASS HINGE | 2.000 | PC | 0H2655A1 | STAINL.<br>STEEL DRIP<br>DRAIN TUBE<br>INT-D-6 | 1.000 | PC | 0H4277A0 | XVC505<br>EXTERNAL<br>GLASS<br>HOLDING<br>PROFILE | 2.000 | PC | 0H4310A0 | ST. STEEL<br>HEAT-GUARD<br>FOR<br>CONTROL<br>PANEL | 1.000 | PC | CE1275A0 | 3M POWER -<br>CONTROL<br>CONNECTION<br>CABLE | 1.000 | PC | CE1285A0 | EMI ROUND<br>FERRITE<br>MOD.26438015<br>02 | 2.000 | PC | CE1290A0 | EXTRACTABL<br>E FEMALE<br>TERMINAL<br>CPF 5/4 | 2.000 | PC | CE1310A1 | POWER -<br>CONTROL<br>BOARD<br>CONNECTING<br>CABLE | 1.000 | PC | CE1665A0 | LED POWER<br>SUPPLY 1 M<br>CABLE | 1.000 | PC |
| Code      | Description  | Qty   | UOM                      |   |  |      |             |     |     |          |                                 |       |    |      |             |     |     |          |   |       |    |          |  |       |    |          |   |       |    |          |  |       |    |          |  |       |    |          |  |       |    |          |   |       |    |          |  |       |    |          |                                  |       |    |
| VT1135A0  | 743x620x6<br>INNER GLASS                           | 1.000   | PC                       |   |  |      |             |     |     |          |                                 |       |    |      |             |     |     |          |   |       |    |          |  |       |    |          |   |       |    |          |  |       |    |          |  |       |    |          |  |       |    |          |   |       |    |          |  |       |    |          |                                  |       |    |
| Code      | Description  | Qty   | UOM                      |   |  |      |             |     |     |          |                                 |       |    |      |             |     |     |          |   |       |    |          |  |       |    |          |   |       |    |          |  |       |    |          |  |       |    |          |  |       |    |          |   |       |    |          |  |       |    |          |                                  |       |    |
| 0H2650A0  | XBC/XVC ST.<br>STEEL<br>INTERNAL<br>GLASS HINGE    | 2.000   | PC                       |   |  |      |             |     |     |          |                                 |       |    |      |             |     |     |          |   |       |    |          |  |       |    |          |   |       |    |          |  |       |    |          |  |       |    |          |  |       |    |          |   |       |    |          |  |       |    |          |                                  |       |    |
| 0H2655A1  | STAINL.<br>STEEL DRIP<br>DRAIN TUBE<br>INT-D-6     | 1.000   | PC                       |   |  |      |             |     |     |          |                                 |       |    |      |             |     |     |          |   |       |    |          |  |       |    |          |   |       |    |          |  |       |    |          |  |       |    |          |  |       |    |          |   |       |    |          |  |       |    |          |                                  |       |    |
| 0H4277A0  | XVC505<br>EXTERNAL<br>GLASS<br>HOLDING<br>PROFILE  | 2.000   | PC                       |   |  |      |             |     |     |          |                                 |       |    |      |             |     |     |          |   |       |    |          |  |       |    |          |   |       |    |          |  |       |    |          |  |       |    |          |  |       |    |          |   |       |    |          |  |       |    |          |                                  |       |    |
| 0H4310A0  | ST. STEEL<br>HEAT-GUARD<br>FOR<br>CONTROL<br>PANEL | 1.000   | PC                       |   |  |      |             |     |     |          |                                 |       |    |      |             |     |     |          |   |       |    |          |  |       |    |          |   |       |    |          |  |       |    |          |  |       |    |          |  |       |    |          |   |       |    |          |  |       |    |          |                                  |       |    |
| CE1275A0  | 3M POWER -<br>CONTROL<br>CONNECTION<br>CABLE       | 1.000   | PC                       |   |  |      |             |     |     |          |                                 |       |    |      |             |     |     |          |   |       |    |          |  |       |    |          |   |       |    |          |  |       |    |          |  |       |    |          |  |       |    |          |   |       |    |          |  |       |    |          |                                  |       |    |
| CE1285A0  | EMI ROUND<br>FERRITE<br>MOD.26438015<br>02         | 2.000   | PC                       |   |  |      |             |     |     |          |                                 |       |    |      |             |     |     |          |   |       |    |          |  |       |    |          |   |       |    |          |  |       |    |          |  |       |    |          |  |       |    |          |   |       |    |          |  |       |    |          |                                  |       |    |
| CE1290A0  | EXTRACTABL<br>E FEMALE<br>TERMINAL<br>CPF 5/4      | 2.000   | PC                       |   |  |      |             |     |     |          |                                 |       |    |      |             |     |     |          |   |       |    |          |  |       |    |          |   |       |    |          |  |       |    |          |  |       |    |          |  |       |    |          |   |       |    |          |  |       |    |          |                                  |       |    |
| CE1310A1  | POWER -<br>CONTROL<br>BOARD<br>CONNECTING<br>CABLE | 1.000   | PC                       |   |  |      |             |     |     |          |                                 |       |    |      |             |     |     |          |   |       |    |          |  |       |    |          |   |       |    |          |  |       |    |          |  |       |    |          |  |       |    |          |   |       |    |          |  |       |    |          |                                  |       |    |
| CE1665A0  | LED POWER<br>SUPPLY 1 M<br>CABLE                   | 1.000   | PC                       |   |  |      |             |     |     |          |                                 |       |    |      |             |     |     |          |   |       |    |          |  |       |    |          |   |       |    |          |  |       |    |          |  |       |    |          |  |       |    |          |   |       |    |          |  |       |    |          |                                  |       |    |



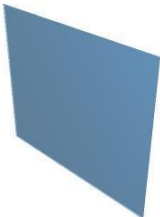

| COMPONENT |                              |   | SPARE PART |                               |  |                                       |             |     |     |          |                                     |       |    |          |                       |       |    |          |                   |       |    |          |                               |       |    |          |                              |        |    |          |                                |       |    |          |                               |       |    |          |                                   |       |    |          |                                  |       |    |          |                                   |       |    |          |                                       |       |    |          |                                      |       |    |          |                              |       |    |          |                         |       |    |          |                                |        |    |          |                        |        |    |          |                             |       |    |          |                              |       |    |
|-----------|------------------------------|---|------------|-------------------------------|--|---------------------------------------|-------------|-----|-----|----------|-------------------------------------|-------|----|----------|-----------------------|-------|----|----------|-------------------|-------|----|----------|-------------------------------|-------|----|----------|------------------------------|--------|----|----------|--------------------------------|-------|----|----------|-------------------------------|-------|----|----------|-----------------------------------|-------|----|----------|----------------------------------|-------|----|----------|-----------------------------------|-------|----|----------|---------------------------------------|-------|----|----------|--------------------------------------|-------|----|----------|------------------------------|-------|----|----------|-------------------------|-------|----|----------|--------------------------------|--------|----|----------|------------------------|--------|----|----------|-----------------------------|-------|----|----------|------------------------------|-------|----|
| Code      | Description                  | Image   | Code       | Description                   | Kit components   |                                       |             |     |     |          |                                     |       |    |          |                       |       |    |          |                   |       |    |          |                               |       |    |          |                              |        |    |          |                                |       |    |          |                               |       |    |          |                                   |       |    |          |                                  |       |    |          |                                   |       |    |          |                                       |       |    |          |                                      |       |    |          |                              |       |    |          |                         |       |    |          |                                |        |    |          |                        |        |    |          |                             |       |    |          |                              |       |    |
| VT1135A   | 743x620x6 INNER GLASS        |  | KDR1136B   | XBC605/XVC1205P COMPLETE DOOR | <table border="1"> <thead> <tr> <th>Code</th> <th>Description</th> <th>Qty</th> <th>UOM</th> </tr> </thead> <tbody> <tr> <td>GN1180A0</td> <td>INTERNAL GLASS HINGE CARBOGRAPH ITE</td> <td>4.000</td> <td>PC</td> </tr> <tr> <td>LP1002B0</td> <td>LED LIGHTING BAR L400</td> <td>1.000</td> <td>PC</td> </tr> <tr> <td>MG1030B2</td> <td>CT-BT DOOR HANDLE</td> <td>1.000</td> <td>PC</td> </tr> <tr> <td>SL1110A0</td> <td>BIADHESIVE PIN 3M VHB 9473-PC</td> <td>1.000</td> <td>PC</td> </tr> <tr> <td>SL1155A1</td> <td>LOCTITE BICOMPONEN T SILICON</td> <td>24.000</td> <td>ML</td> </tr> <tr> <td>TB1190A0</td> <td>XVC505 XBC605 RIGHT DOOR COLUM</td> <td>1.000</td> <td>PC</td> </tr> <tr> <td>TB1191A1</td> <td>XVC505 XBC605 LEFT DOOR COLUM</td> <td>1.000</td> <td>PC</td> </tr> <tr> <td>TB1225A0</td> <td>XBC405/605/80 5 DOOR UPPER LISTEL</td> <td>1.000</td> <td>PC</td> </tr> <tr> <td>TB1226A0</td> <td>XBC405/605/80 5 DOOR LOWER LISTE</td> <td>1.000</td> <td>PC</td> </tr> <tr> <td>TF1010A0</td> <td>TEFLON BUSHING FOR INTERNAL GLASS</td> <td>2.000</td> <td>PC</td> </tr> <tr> <td>VE1030A1</td> <td>MAGNET FOR DOOR MICROSWITC H D=22,9mm</td> <td>2.000</td> <td>PC</td> </tr> <tr> <td>VI0239A1</td> <td>SELF-TAPPIN G SCREW 4.2X25 TCB+ INOX</td> <td>4.000</td> <td>PC</td> </tr> <tr> <td>VI1070A0</td> <td>SCREW M4x16 TSP/UNI7688 INOX</td> <td>2.000</td> <td>PC</td> </tr> <tr> <td>VI1075A0</td> <td>NUT M4 H=4 UNI5587 INOX</td> <td>2.000</td> <td>PC</td> </tr> <tr> <td>VI1220A1</td> <td>4,2x12 TCB SELF-TAPPIN G SCREW</td> <td>19.000</td> <td>PC</td> </tr> <tr> <td>VI1300A0</td> <td>SCREW M6X12 T1/2T+INOX</td> <td>12.000</td> <td>PC</td> </tr> <tr> <td>VI1310A0</td> <td>ZINC THREAD INSERT M6 FTR/E</td> <td>8.000</td> <td>PC</td> </tr> <tr> <td>VI1340A0</td> <td>M6 ST. STEEL THREADED INSERT</td> <td>4.000</td> <td>PC</td> </tr> </tbody> </table> | Code                                  | Description | Qty | UOM | GN1180A0 | INTERNAL GLASS HINGE CARBOGRAPH ITE | 4.000 | PC | LP1002B0 | LED LIGHTING BAR L400 | 1.000 | PC | MG1030B2 | CT-BT DOOR HANDLE | 1.000 | PC | SL1110A0 | BIADHESIVE PIN 3M VHB 9473-PC | 1.000 | PC | SL1155A1 | LOCTITE BICOMPONEN T SILICON | 24.000 | ML | TB1190A0 | XVC505 XBC605 RIGHT DOOR COLUM | 1.000 | PC | TB1191A1 | XVC505 XBC605 LEFT DOOR COLUM | 1.000 | PC | TB1225A0 | XBC405/605/80 5 DOOR UPPER LISTEL | 1.000 | PC | TB1226A0 | XBC405/605/80 5 DOOR LOWER LISTE | 1.000 | PC | TF1010A0 | TEFLON BUSHING FOR INTERNAL GLASS | 2.000 | PC | VE1030A1 | MAGNET FOR DOOR MICROSWITC H D=22,9mm | 2.000 | PC | VI0239A1 | SELF-TAPPIN G SCREW 4.2X25 TCB+ INOX | 4.000 | PC | VI1070A0 | SCREW M4x16 TSP/UNI7688 INOX | 2.000 | PC | VI1075A0 | NUT M4 H=4 UNI5587 INOX | 2.000 | PC | VI1220A1 | 4,2x12 TCB SELF-TAPPIN G SCREW | 19.000 | PC | VI1300A0 | SCREW M6X12 T1/2T+INOX | 12.000 | PC | VI1310A0 | ZINC THREAD INSERT M6 FTR/E | 8.000 | PC | VI1340A0 | M6 ST. STEEL THREADED INSERT | 4.000 | PC |
|           |                              |   |            |                               | Code   | Description                           | Qty         | UOM |     |          |                                     |       |    |          |                       |       |    |          |                   |       |    |          |                               |       |    |          |                              |        |    |          |                                |       |    |          |                               |       |    |          |                                   |       |    |          |                                  |       |    |          |                                   |       |    |          |                                       |       |    |          |                                      |       |    |          |                              |       |    |          |                         |       |    |          |                                |        |    |          |                        |        |    |          |                             |       |    |          |                              |       |    |
|           |                              |   |            |                               | GN1180A0   | INTERNAL GLASS HINGE CARBOGRAPH ITE   | 4.000       | PC  |     |          |                                     |       |    |          |                       |       |    |          |                   |       |    |          |                               |       |    |          |                              |        |    |          |                                |       |    |          |                               |       |    |          |                                   |       |    |          |                                  |       |    |          |                                   |       |    |          |                                       |       |    |          |                                      |       |    |          |                              |       |    |          |                         |       |    |          |                                |        |    |          |                        |        |    |          |                             |       |    |          |                              |       |    |
|           |                              |   |            |                               | LP1002B0   | LED LIGHTING BAR L400                 | 1.000       | PC  |     |          |                                     |       |    |          |                       |       |    |          |                   |       |    |          |                               |       |    |          |                              |        |    |          |                                |       |    |          |                               |       |    |          |                                   |       |    |          |                                  |       |    |          |                                   |       |    |          |                                       |       |    |          |                                      |       |    |          |                              |       |    |          |                         |       |    |          |                                |        |    |          |                        |        |    |          |                             |       |    |          |                              |       |    |
|           |                              |   |            |                               | MG1030B2   | CT-BT DOOR HANDLE                     | 1.000       | PC  |     |          |                                     |       |    |          |                       |       |    |          |                   |       |    |          |                               |       |    |          |                              |        |    |          |                                |       |    |          |                               |       |    |          |                                   |       |    |          |                                  |       |    |          |                                   |       |    |          |                                       |       |    |          |                                      |       |    |          |                              |       |    |          |                         |       |    |          |                                |        |    |          |                        |        |    |          |                             |       |    |          |                              |       |    |
|           |                              |   |            |                               | SL1110A0   | BIADHESIVE PIN 3M VHB 9473-PC         | 1.000       | PC  |     |          |                                     |       |    |          |                       |       |    |          |                   |       |    |          |                               |       |    |          |                              |        |    |          |                                |       |    |          |                               |       |    |          |                                   |       |    |          |                                  |       |    |          |                                   |       |    |          |                                       |       |    |          |                                      |       |    |          |                              |       |    |          |                         |       |    |          |                                |        |    |          |                        |        |    |          |                             |       |    |          |                              |       |    |
|           |                              |   |            |                               | SL1155A1   | LOCTITE BICOMPONEN T SILICON          | 24.000      | ML  |     |          |                                     |       |    |          |                       |       |    |          |                   |       |    |          |                               |       |    |          |                              |        |    |          |                                |       |    |          |                               |       |    |          |                                   |       |    |          |                                  |       |    |          |                                   |       |    |          |                                       |       |    |          |                                      |       |    |          |                              |       |    |          |                         |       |    |          |                                |        |    |          |                        |        |    |          |                             |       |    |          |                              |       |    |
|           |                              |   |            |                               | TB1190A0   | XVC505 XBC605 RIGHT DOOR COLUM        | 1.000       | PC  |     |          |                                     |       |    |          |                       |       |    |          |                   |       |    |          |                               |       |    |          |                              |        |    |          |                                |       |    |          |                               |       |    |          |                                   |       |    |          |                                  |       |    |          |                                   |       |    |          |                                       |       |    |          |                                      |       |    |          |                              |       |    |          |                         |       |    |          |                                |        |    |          |                        |        |    |          |                             |       |    |          |                              |       |    |
|           |                              |   |            |                               | TB1191A1   | XVC505 XBC605 LEFT DOOR COLUM         | 1.000       | PC  |     |          |                                     |       |    |          |                       |       |    |          |                   |       |    |          |                               |       |    |          |                              |        |    |          |                                |       |    |          |                               |       |    |          |                                   |       |    |          |                                  |       |    |          |                                   |       |    |          |                                       |       |    |          |                                      |       |    |          |                              |       |    |          |                         |       |    |          |                                |        |    |          |                        |        |    |          |                             |       |    |          |                              |       |    |
|           |                              |   |            |                               | TB1225A0   | XBC405/605/80 5 DOOR UPPER LISTEL     | 1.000       | PC  |     |          |                                     |       |    |          |                       |       |    |          |                   |       |    |          |                               |       |    |          |                              |        |    |          |                                |       |    |          |                               |       |    |          |                                   |       |    |          |                                  |       |    |          |                                   |       |    |          |                                       |       |    |          |                                      |       |    |          |                              |       |    |          |                         |       |    |          |                                |        |    |          |                        |        |    |          |                             |       |    |          |                              |       |    |
|           |                              |   |            |                               | TB1226A0   | XBC405/605/80 5 DOOR LOWER LISTE      | 1.000       | PC  |     |          |                                     |       |    |          |                       |       |    |          |                   |       |    |          |                               |       |    |          |                              |        |    |          |                                |       |    |          |                               |       |    |          |                                   |       |    |          |                                  |       |    |          |                                   |       |    |          |                                       |       |    |          |                                      |       |    |          |                              |       |    |          |                         |       |    |          |                                |        |    |          |                        |        |    |          |                             |       |    |          |                              |       |    |
|           |                              |   |            |                               | TF1010A0   | TEFLON BUSHING FOR INTERNAL GLASS     | 2.000       | PC  |     |          |                                     |       |    |          |                       |       |    |          |                   |       |    |          |                               |       |    |          |                              |        |    |          |                                |       |    |          |                               |       |    |          |                                   |       |    |          |                                  |       |    |          |                                   |       |    |          |                                       |       |    |          |                                      |       |    |          |                              |       |    |          |                         |       |    |          |                                |        |    |          |                        |        |    |          |                             |       |    |          |                              |       |    |
|           |                              |   |            |                               | VE1030A1   | MAGNET FOR DOOR MICROSWITC H D=22,9mm | 2.000       | PC  |     |          |                                     |       |    |          |                       |       |    |          |                   |       |    |          |                               |       |    |          |                              |        |    |          |                                |       |    |          |                               |       |    |          |                                   |       |    |          |                                  |       |    |          |                                   |       |    |          |                                       |       |    |          |                                      |       |    |          |                              |       |    |          |                         |       |    |          |                                |        |    |          |                        |        |    |          |                             |       |    |          |                              |       |    |
|           |                              |   |            |                               | VI0239A1   | SELF-TAPPIN G SCREW 4.2X25 TCB+ INOX  | 4.000       | PC  |     |          |                                     |       |    |          |                       |       |    |          |                   |       |    |          |                               |       |    |          |                              |        |    |          |                                |       |    |          |                               |       |    |          |                                   |       |    |          |                                  |       |    |          |                                   |       |    |          |                                       |       |    |          |                                      |       |    |          |                              |       |    |          |                         |       |    |          |                                |        |    |          |                        |        |    |          |                             |       |    |          |                              |       |    |
|           |                              |   |            |                               | VI1070A0   | SCREW M4x16 TSP/UNI7688 INOX          | 2.000       | PC  |     |          |                                     |       |    |          |                       |       |    |          |                   |       |    |          |                               |       |    |          |                              |        |    |          |                                |       |    |          |                               |       |    |          |                                   |       |    |          |                                  |       |    |          |                                   |       |    |          |                                       |       |    |          |                                      |       |    |          |                              |       |    |          |                         |       |    |          |                                |        |    |          |                        |        |    |          |                             |       |    |          |                              |       |    |
|           |                              |   |            |                               | VI1075A0   | NUT M4 H=4 UNI5587 INOX               | 2.000       | PC  |     |          |                                     |       |    |          |                       |       |    |          |                   |       |    |          |                               |       |    |          |                              |        |    |          |                                |       |    |          |                               |       |    |          |                                   |       |    |          |                                  |       |    |          |                                   |       |    |          |                                       |       |    |          |                                      |       |    |          |                              |       |    |          |                         |       |    |          |                                |        |    |          |                        |        |    |          |                             |       |    |          |                              |       |    |
|           |                              |   |            |                               | VI1220A1   | 4,2x12 TCB SELF-TAPPIN G SCREW        | 19.000      | PC  |     |          |                                     |       |    |          |                       |       |    |          |                   |       |    |          |                               |       |    |          |                              |        |    |          |                                |       |    |          |                               |       |    |          |                                   |       |    |          |                                  |       |    |          |                                   |       |    |          |                                       |       |    |          |                                      |       |    |          |                              |       |    |          |                         |       |    |          |                                |        |    |          |                        |        |    |          |                             |       |    |          |                              |       |    |
| VI1300A0  | SCREW M6X12 T1/2T+INOX       | 12.000  | PC         |                               |  |                                       |             |     |     |          |                                     |       |    |          |                       |       |    |          |                   |       |    |          |                               |       |    |          |                              |        |    |          |                                |       |    |          |                               |       |    |          |                                   |       |    |          |                                  |       |    |          |                                   |       |    |          |                                       |       |    |          |                                      |       |    |          |                              |       |    |          |                         |       |    |          |                                |        |    |          |                        |        |    |          |                             |       |    |          |                              |       |    |
| VI1310A0  | ZINC THREAD INSERT M6 FTR/E  | 8.000   | PC         |                               |  |                                       |             |     |     |          |                                     |       |    |          |                       |       |    |          |                   |       |    |          |                               |       |    |          |                              |        |    |          |                                |       |    |          |                               |       |    |          |                                   |       |    |          |                                  |       |    |          |                                   |       |    |          |                                       |       |    |          |                                      |       |    |          |                              |       |    |          |                         |       |    |          |                                |        |    |          |                        |        |    |          |                             |       |    |          |                              |       |    |
| VI1340A0  | M6 ST. STEEL THREADED INSERT | 4.000   | PC         |                               |  |                                       |             |     |     |          |                                     |       |    |          |                       |       |    |          |                   |       |    |          |                               |       |    |          |                              |        |    |          |                                |       |    |          |                               |       |    |          |                                   |       |    |          |                                  |       |    |          |                                   |       |    |          |                                       |       |    |          |                                      |       |    |          |                              |       |    |          |                         |       |    |          |                                |        |    |          |                        |        |    |          |                             |       |    |          |                              |       |    |

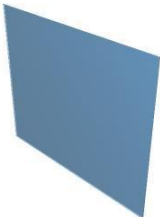

| COMPONENT |  |   | SPARE PART |                               |  |      |             |     |     |          |                                     |        |    |          |                                      |       |    |          |                          |       |    |          |                  |       |    |          |                       |       |    |          |                       |       |    |          |                         |       |    |          |  |       |    |          |                                    |       |    |          |                                    |       |    |          |                                |       |    |          |                                |       |    |          |                                       |       |    |          |                                  |       |    |          |                                |       |    |          |                       |       |    |
|-----------|--|---|------------|-------------------------------|--|------|-------------|-----|-----|----------|-------------------------------------|--------|----|----------|--------------------------------------|-------|----|----------|--------------------------|-------|----|----------|------------------|-------|----|----------|-----------------------|-------|----|----------|-----------------------|-------|----|----------|-------------------------|-------|----|----------|--|-------|----|----------|------------------------------------|-------|----|----------|------------------------------------|-------|----|----------|--------------------------------|-------|----|----------|--------------------------------|-------|----|----------|---------------------------------------|-------|----|----------|----------------------------------|-------|----|----------|--------------------------------|-------|----|----------|-----------------------|-------|----|
| Code      | Description                            | Image   | Code       | Description                   | Kit components   |      |             |     |     |          |                                     |        |    |          |                                      |       |    |          |                          |       |    |          |                  |       |    |          |                       |       |    |          |                       |       |    |          |                         |       |    |          |  |       |    |          |                                    |       |    |          |                                    |       |    |          |                                |       |    |          |                                |       |    |          |                                       |       |    |          |                                  |       |    |          |                                |       |    |          |                       |       |    |
| VT1135A   | 743x620x6 INNER GLASS                  |  | KDR1136B   | XBC605/XVC1205P COMPLETE DOOR | <table border="1"> <thead> <tr> <th>Code</th> <th>Description</th> <th>Qty</th> <th>UOM</th> </tr> </thead> <tbody> <tr> <td>VI1810A0</td> <td>M6X6 STAINLESS STEEL FLATHEAD SCREW</td> <td>12.000</td> <td>PC</td> </tr> <tr> <td>VI1895A0</td> <td>BLIND NUT M4 STAINLESS STEEL DIN 917</td> <td>6.000</td> <td>PC</td> </tr> <tr> <td>VI1945A0</td> <td>ENG-VITE M4x20 TCB+ INOX</td> <td>6.000</td> <td>PC</td> </tr> <tr> <td>VM1145A1</td> <td>C.T. BOARD FRAME</td> <td>1.000</td> <td>PC</td> </tr> <tr> <td>VM1170B0</td> <td>UPPER DOOR FULCRUM CA</td> <td>1.000</td> <td>PC</td> </tr> <tr> <td>VM1171B0</td> <td>DOOR LOWER FULCRUM CA</td> <td>1.000</td> <td>PC</td> </tr> <tr> <td>VM1175A0</td> <td>DOOR COLUMN BLANKING CA</td> <td>2.000</td> <td>PC</td> </tr> <tr> <td>VM1207A0</td> <td>DOOR DROP PRESERVER FORM XBC404/604/80</td> <td>1.000</td> <td>PC</td> </tr> <tr> <td>VM1230A0</td> <td>UPPER ALUMINIUM HINGE FOR INTERNAL</td> <td>2.000</td> <td>PC</td> </tr> <tr> <td>VM1231A0</td> <td>LOWER ALUMINIUM HINGE FOR INTERNAL</td> <td>2.000</td> <td>PC</td> </tr> <tr> <td>VM1235A0</td> <td>UPPER HOOK TO STOP INNER GLASS</td> <td>1.000</td> <td>PC</td> </tr> <tr> <td>VM1236A0</td> <td>LOWER HOOK TO STOP INNER GLASS</td> <td>1.000</td> <td>PC</td> </tr> <tr> <td>VM1490A0</td> <td>CHEFTOP/BAK ERTOP HANDLE SCREWS COVER</td> <td>2.000</td> <td>PC</td> </tr> <tr> <td>VM1510A0</td> <td>XBC/XVC GROOVED DOOR PIN BUSHING</td> <td>1.000</td> <td>PC</td> </tr> <tr> <td>VM1511A0</td> <td>XBC/XVC SLEEK DOOR PIN BUSHING</td> <td>1.000</td> <td>PC</td> </tr> <tr> <td>VM1620A0</td> <td>LED BAR LOWER SUPPORT</td> <td>1.000</td> <td>PC</td> </tr> </tbody> </table> | Code | Description | Qty | UOM | VI1810A0 | M6X6 STAINLESS STEEL FLATHEAD SCREW | 12.000 | PC | VI1895A0 | BLIND NUT M4 STAINLESS STEEL DIN 917 | 6.000 | PC | VI1945A0 | ENG-VITE M4x20 TCB+ INOX | 6.000 | PC | VM1145A1 | C.T. BOARD FRAME | 1.000 | PC | VM1170B0 | UPPER DOOR FULCRUM CA | 1.000 | PC | VM1171B0 | DOOR LOWER FULCRUM CA | 1.000 | PC | VM1175A0 | DOOR COLUMN BLANKING CA | 2.000 | PC | VM1207A0 | DOOR DROP PRESERVER FORM XBC404/604/80 | 1.000 | PC | VM1230A0 | UPPER ALUMINIUM HINGE FOR INTERNAL | 2.000 | PC | VM1231A0 | LOWER ALUMINIUM HINGE FOR INTERNAL | 2.000 | PC | VM1235A0 | UPPER HOOK TO STOP INNER GLASS | 1.000 | PC | VM1236A0 | LOWER HOOK TO STOP INNER GLASS | 1.000 | PC | VM1490A0 | CHEFTOP/BAK ERTOP HANDLE SCREWS COVER | 2.000 | PC | VM1510A0 | XBC/XVC GROOVED DOOR PIN BUSHING | 1.000 | PC | VM1511A0 | XBC/XVC SLEEK DOOR PIN BUSHING | 1.000 | PC | VM1620A0 | LED BAR LOWER SUPPORT | 1.000 | PC |
| Code      | Description                            | Qty   | UOM        |                               |  |      |             |     |     |          |                                     |        |    |          |                                      |       |    |          |                          |       |    |          |                  |       |    |          |                       |       |    |          |                       |       |    |          |                         |       |    |          |  |       |    |          |                                    |       |    |          |                                    |       |    |          |                                |       |    |          |                                |       |    |          |                                       |       |    |          |                                  |       |    |          |                                |       |    |          |                       |       |    |
| VI1810A0  | M6X6 STAINLESS STEEL FLATHEAD SCREW    | 12.000  | PC         |                               |  |      |             |     |     |          |                                     |        |    |          |                                      |       |    |          |                          |       |    |          |                  |       |    |          |                       |       |    |          |                       |       |    |          |                         |       |    |          |  |       |    |          |                                    |       |    |          |                                    |       |    |          |                                |       |    |          |                                |       |    |          |                                       |       |    |          |                                  |       |    |          |                                |       |    |          |                       |       |    |
| VI1895A0  | BLIND NUT M4 STAINLESS STEEL DIN 917   | 6.000   | PC         |                               |  |      |             |     |     |          |                                     |        |    |          |                                      |       |    |          |                          |       |    |          |                  |       |    |          |                       |       |    |          |                       |       |    |          |                         |       |    |          |  |       |    |          |                                    |       |    |          |                                    |       |    |          |                                |       |    |          |                                |       |    |          |                                       |       |    |          |                                  |       |    |          |                                |       |    |          |                       |       |    |
| VI1945A0  | ENG-VITE M4x20 TCB+ INOX               | 6.000   | PC         |                               |  |      |             |     |     |          |                                     |        |    |          |                                      |       |    |          |                          |       |    |          |                  |       |    |          |                       |       |    |          |                       |       |    |          |                         |       |    |          |  |       |    |          |                                    |       |    |          |                                    |       |    |          |                                |       |    |          |                                |       |    |          |                                       |       |    |          |                                  |       |    |          |                                |       |    |          |                       |       |    |
| VM1145A1  | C.T. BOARD FRAME                       | 1.000   | PC         |                               |  |      |             |     |     |          |                                     |        |    |          |                                      |       |    |          |                          |       |    |          |                  |       |    |          |                       |       |    |          |                       |       |    |          |                         |       |    |          |  |       |    |          |                                    |       |    |          |                                    |       |    |          |                                |       |    |          |                                |       |    |          |                                       |       |    |          |                                  |       |    |          |                                |       |    |          |                       |       |    |
| VM1170B0  | UPPER DOOR FULCRUM CA                  | 1.000   | PC         |                               |  |      |             |     |     |          |                                     |        |    |          |                                      |       |    |          |                          |       |    |          |                  |       |    |          |                       |       |    |          |                       |       |    |          |                         |       |    |          |  |       |    |          |                                    |       |    |          |                                    |       |    |          |                                |       |    |          |                                |       |    |          |                                       |       |    |          |                                  |       |    |          |                                |       |    |          |                       |       |    |
| VM1171B0  | DOOR LOWER FULCRUM CA                  | 1.000   | PC         |                               |  |      |             |     |     |          |                                     |        |    |          |                                      |       |    |          |                          |       |    |          |                  |       |    |          |                       |       |    |          |                       |       |    |          |                         |       |    |          |  |       |    |          |                                    |       |    |          |                                    |       |    |          |                                |       |    |          |                                |       |    |          |                                       |       |    |          |                                  |       |    |          |                                |       |    |          |                       |       |    |
| VM1175A0  | DOOR COLUMN BLANKING CA                | 2.000   | PC         |                               |  |      |             |     |     |          |                                     |        |    |          |                                      |       |    |          |                          |       |    |          |                  |       |    |          |                       |       |    |          |                       |       |    |          |                         |       |    |          |  |       |    |          |                                    |       |    |          |                                    |       |    |          |                                |       |    |          |                                |       |    |          |                                       |       |    |          |                                  |       |    |          |                                |       |    |          |                       |       |    |
| VM1207A0  | DOOR DROP PRESERVER FORM XBC404/604/80 | 1.000   | PC         |                               |  |      |             |     |     |          |                                     |        |    |          |                                      |       |    |          |                          |       |    |          |                  |       |    |          |                       |       |    |          |                       |       |    |          |                         |       |    |          |  |       |    |          |                                    |       |    |          |                                    |       |    |          |                                |       |    |          |                                |       |    |          |                                       |       |    |          |                                  |       |    |          |                                |       |    |          |                       |       |    |
| VM1230A0  | UPPER ALUMINIUM HINGE FOR INTERNAL     | 2.000   | PC         |                               |  |      |             |     |     |          |                                     |        |    |          |                                      |       |    |          |                          |       |    |          |                  |       |    |          |                       |       |    |          |                       |       |    |          |                         |       |    |          |  |       |    |          |                                    |       |    |          |                                    |       |    |          |                                |       |    |          |                                |       |    |          |                                       |       |    |          |                                  |       |    |          |                                |       |    |          |                       |       |    |
| VM1231A0  | LOWER ALUMINIUM HINGE FOR INTERNAL     | 2.000   | PC         |                               |  |      |             |     |     |          |                                     |        |    |          |                                      |       |    |          |                          |       |    |          |                  |       |    |          |                       |       |    |          |                       |       |    |          |                         |       |    |          |  |       |    |          |                                    |       |    |          |                                    |       |    |          |                                |       |    |          |                                |       |    |          |                                       |       |    |          |                                  |       |    |          |                                |       |    |          |                       |       |    |
| VM1235A0  | UPPER HOOK TO STOP INNER GLASS         | 1.000   | PC         |                               |  |      |             |     |     |          |                                     |        |    |          |                                      |       |    |          |                          |       |    |          |                  |       |    |          |                       |       |    |          |                       |       |    |          |                         |       |    |          |  |       |    |          |                                    |       |    |          |                                    |       |    |          |                                |       |    |          |                                |       |    |          |                                       |       |    |          |                                  |       |    |          |                                |       |    |          |                       |       |    |
| VM1236A0  | LOWER HOOK TO STOP INNER GLASS         | 1.000   | PC         |                               |  |      |             |     |     |          |                                     |        |    |          |                                      |       |    |          |                          |       |    |          |                  |       |    |          |                       |       |    |          |                       |       |    |          |                         |       |    |          |  |       |    |          |                                    |       |    |          |                                    |       |    |          |                                |       |    |          |                                |       |    |          |                                       |       |    |          |                                  |       |    |          |                                |       |    |          |                       |       |    |
| VM1490A0  | CHEFTOP/BAK ERTOP HANDLE SCREWS COVER  | 2.000   | PC         |                               |  |      |             |     |     |          |                                     |        |    |          |                                      |       |    |          |                          |       |    |          |                  |       |    |          |                       |       |    |          |                       |       |    |          |                         |       |    |          |  |       |    |          |                                    |       |    |          |                                    |       |    |          |                                |       |    |          |                                |       |    |          |                                       |       |    |          |                                  |       |    |          |                                |       |    |          |                       |       |    |
| VM1510A0  | XBC/XVC GROOVED DOOR PIN BUSHING       | 1.000   | PC         |                               |  |      |             |     |     |          |                                     |        |    |          |                                      |       |    |          |                          |       |    |          |                  |       |    |          |                       |       |    |          |                       |       |    |          |                         |       |    |          |  |       |    |          |                                    |       |    |          |                                    |       |    |          |                                |       |    |          |                                |       |    |          |                                       |       |    |          |                                  |       |    |          |                                |       |    |          |                       |       |    |
| VM1511A0  | XBC/XVC SLEEK DOOR PIN BUSHING         | 1.000   | PC         |                               |  |      |             |     |     |          |                                     |        |    |          |                                      |       |    |          |                          |       |    |          |                  |       |    |          |                       |       |    |          |                       |       |    |          |                         |       |    |          |  |       |    |          |                                    |       |    |          |                                    |       |    |          |                                |       |    |          |                                |       |    |          |                                       |       |    |          |                                  |       |    |          |                                |       |    |          |                       |       |    |
| VM1620A0  | LED BAR LOWER SUPPORT                  | 1.000   | PC         |                               |  |      |             |     |     |          |                                     |        |    |          |                                      |       |    |          |                          |       |    |          |                  |       |    |          |                       |       |    |          |                       |       |    |          |                         |       |    |          |  |       |    |          |                                    |       |    |          |                                    |       |    |          |                                |       |    |          |                                |       |    |          |                                       |       |    |          |                                  |       |    |          |                                |       |    |          |                       |       |    |

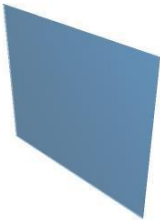

| COMPONENT |  |   | SPARE PART |                               |   |      |             |     |     |          |                       |       |    |          |                                   |       |    |          |  |       |    |          |                          |       |    |          |                                 |       |    |          |                               |       |    |          |             |       |    |          |                       |       |    |          |                       |       |    |
|-----------|--|---|------------|-------------------------------|---|------|-------------|-----|-----|----------|-----------------------|-------|----|----------|-----------------------------------|-------|----|----------|--|-------|----|----------|--------------------------|-------|----|----------|---------------------------------|-------|----|----------|-------------------------------|-------|----|----------|-------------|-------|----|----------|-----------------------|-------|----|----------|-----------------------|-------|----|
| Code      | Description                            | Image   | Code       | Description                   | Kit components  |      |             |     |     |          |                       |       |    |          |                                   |       |    |          |  |       |    |          |                          |       |    |          |                                 |       |    |          |                               |       |    |          |             |       |    |          |                       |       |    |          |                       |       |    |
| VT1135A   | 743x620x6 INNER GLASS                  |    | KDR1136B   | XBC605/XVC1205P COMPLETE DOOR | <table border="1"> <thead> <tr> <th>Code</th> <th>Description</th> <th>Qty</th> <th>UOM</th> </tr> </thead> <tbody> <tr> <td>VM1621A0</td> <td>LED BAR UPPER SUPPORT</td> <td>1.000</td> <td>PC</td> </tr> <tr> <td>VT1135A0</td> <td>743x620x6 INNER GLASS</td> <td>1.000</td> <td>PC</td> </tr> <tr> <td>VT1136B0</td> <td>SILKSCREENE D EXTERNAL GLASS 757X743X4</td> <td>1.000</td> <td>PC</td> </tr> </tbody> </table>   | Code | Description | Qty | UOM | VM1621A0 | LED BAR UPPER SUPPORT | 1.000 | PC | VT1135A0 | 743x620x6 INNER GLASS             | 1.000 | PC | VT1136B0 | SILKSCREENE D EXTERNAL GLASS 757X743X4 | 1.000 | PC |          |                          |       |    |          |                                 |       |    |          |                               |       |    |          |             |       |    |          |                       |       |    |          |                       |       |    |
| Code      | Description                            | Qty   | UOM        |                               |   |      |             |     |     |          |                       |       |    |          |                                   |       |    |          |  |       |    |          |                          |       |    |          |                                 |       |    |          |                               |       |    |          |             |       |    |          |                       |       |    |          |                       |       |    |
| VM1621A0  | LED BAR UPPER SUPPORT                  | 1.000   | PC         |                               |   |      |             |     |     |          |                       |       |    |          |                                   |       |    |          |  |       |    |          |                          |       |    |          |                                 |       |    |          |                               |       |    |          |             |       |    |          |                       |       |    |          |                       |       |    |
| VT1135A0  | 743x620x6 INNER GLASS                  | 1.000   | PC         |                               |   |      |             |     |     |          |                       |       |    |          |                                   |       |    |          |  |       |    |          |                          |       |    |          |                                 |       |    |          |                               |       |    |          |             |       |    |          |                       |       |    |          |                       |       |    |
| VT1136B0  | SILKSCREENE D EXTERNAL GLASS 757X743X4 | 1.000   | PC         |                               |   |      |             |     |     |          |                       |       |    |          |                                   |       |    |          |  |       |    |          |                          |       |    |          |                                 |       |    |          |                               |       |    |          |             |       |    |          |                       |       |    |          |                       |       |    |
| LP1044A   | LUX LED BAR                            |   | KLP1044A   | LUX LED BAR KIT               | <table border="1"> <thead> <tr> <th>Code</th> <th>Description</th> <th>Qty</th> <th>UOM</th> </tr> </thead> <tbody> <tr> <td>CE1455A0</td> <td>TIP END FITTING</td> <td>2.000</td> <td>PC</td> </tr> <tr> <td>CE1730A0</td> <td>PVC CABLE NP 2 X AWG22 STYLE 2095</td> <td>1.000</td> <td>M</td> </tr> <tr> <td>CE1735A0</td> <td>MINIFIT FEMALE END FITTING</td> <td>2.000</td> <td>PC</td> </tr> <tr> <td>CE1740A0</td> <td>MINIFIT MALE END FITTING</td> <td>2.000</td> <td>PC</td> </tr> <tr> <td>CE1745A0</td> <td>2 WAYS FEMALE MINIFIT CONNECTOR</td> <td>1.000</td> <td>PC</td> </tr> <tr> <td>CE1750A0</td> <td>3 WAYS MALE MINIFIT CONNECTOR</td> <td>1.000</td> <td>PC</td> </tr> <tr> <td>LP1044A0</td> <td>LUX LED BAR</td> <td>1.000</td> <td>PC</td> </tr> <tr> <td>VM1620A0</td> <td>LED BAR LOWER SUPPORT</td> <td>1.000</td> <td>PC</td> </tr> <tr> <td>VM1621A0</td> <td>LED BAR UPPER SUPPORT</td> <td>1.000</td> <td>PC</td> </tr> </tbody> </table> | Code | Description | Qty | UOM | CE1455A0 | TIP END FITTING       | 2.000 | PC | CE1730A0 | PVC CABLE NP 2 X AWG22 STYLE 2095 | 1.000 | M  | CE1735A0 | MINIFIT FEMALE END FITTING             | 2.000 | PC | CE1740A0 | MINIFIT MALE END FITTING | 2.000 | PC | CE1745A0 | 2 WAYS FEMALE MINIFIT CONNECTOR | 1.000 | PC | CE1750A0 | 3 WAYS MALE MINIFIT CONNECTOR | 1.000 | PC | LP1044A0 | LUX LED BAR | 1.000 | PC | VM1620A0 | LED BAR LOWER SUPPORT | 1.000 | PC | VM1621A0 | LED BAR UPPER SUPPORT | 1.000 | PC |
| Code      | Description                            | Qty   | UOM        |                               |   |      |             |     |     |          |                       |       |    |          |                                   |       |    |          |  |       |    |          |                          |       |    |          |                                 |       |    |          |                               |       |    |          |             |       |    |          |                       |       |    |          |                       |       |    |
| CE1455A0  | TIP END FITTING                        | 2.000   | PC         |                               |   |      |             |     |     |          |                       |       |    |          |                                   |       |    |          |  |       |    |          |                          |       |    |          |                                 |       |    |          |                               |       |    |          |             |       |    |          |                       |       |    |          |                       |       |    |
| CE1730A0  | PVC CABLE NP 2 X AWG22 STYLE 2095      | 1.000   | M          |                               |   |      |             |     |     |          |                       |       |    |          |                                   |       |    |          |  |       |    |          |                          |       |    |          |                                 |       |    |          |                               |       |    |          |             |       |    |          |                       |       |    |          |                       |       |    |
| CE1735A0  | MINIFIT FEMALE END FITTING             | 2.000   | PC         |                               |   |      |             |     |     |          |                       |       |    |          |                                   |       |    |          |  |       |    |          |                          |       |    |          |                                 |       |    |          |                               |       |    |          |             |       |    |          |                       |       |    |          |                       |       |    |
| CE1740A0  | MINIFIT MALE END FITTING               | 2.000   | PC         |                               |   |      |             |     |     |          |                       |       |    |          |                                   |       |    |          |  |       |    |          |                          |       |    |          |                                 |       |    |          |                               |       |    |          |             |       |    |          |                       |       |    |          |                       |       |    |
| CE1745A0  | 2 WAYS FEMALE MINIFIT CONNECTOR        | 1.000   | PC         |                               |   |      |             |     |     |          |                       |       |    |          |                                   |       |    |          |  |       |    |          |                          |       |    |          |                                 |       |    |          |                               |       |    |          |             |       |    |          |                       |       |    |          |                       |       |    |
| CE1750A0  | 3 WAYS MALE MINIFIT CONNECTOR          | 1.000   | PC         |                               |   |      |             |     |     |          |                       |       |    |          |                                   |       |    |          |  |       |    |          |                          |       |    |          |                                 |       |    |          |                               |       |    |          |             |       |    |          |                       |       |    |          |                       |       |    |
| LP1044A0  | LUX LED BAR                            | 1.000   | PC         |                               |   |      |             |     |     |          |                       |       |    |          |                                   |       |    |          |  |       |    |          |                          |       |    |          |                                 |       |    |          |                               |       |    |          |             |       |    |          |                       |       |    |          |                       |       |    |
| VM1620A0  | LED BAR LOWER SUPPORT                  | 1.000   | PC         |                               |   |      |             |     |     |          |                       |       |    |          |                                   |       |    |          |  |       |    |          |                          |       |    |          |                                 |       |    |          |                               |       |    |          |             |       |    |          |                       |       |    |          |                       |       |    |
| VM1621A0  | LED BAR UPPER SUPPORT                  | 1.000   | PC         |                               |   |      |             |     |     |          |                       |       |    |          |                                   |       |    |          |  |       |    |          |                          |       |    |          |                                 |       |    |          |                               |       |    |          |             |       |    |          |                       |       |    |          |                       |       |    |
| VM1620A   | LED BAR LOWER SUPPORT                  |  | KLP1044A   | LUX LED BAR KIT               | <table border="1"> <thead> <tr> <th>Code</th> <th>Description</th> <th>Qty</th> <th>UOM</th> </tr> </thead> <tbody> <tr> <td>CE1455A0</td> <td>TIP END FITTING</td> <td>2.000</td> <td>PC</td> </tr> <tr> <td>CE1730A0</td> <td>PVC CABLE NP 2 X AWG22 STYLE 2095</td> <td>1.000</td> <td>M</td> </tr> <tr> <td>CE1735A0</td> <td>MINIFIT FEMALE END FITTING</td> <td>2.000</td> <td>PC</td> </tr> <tr> <td>CE1740A0</td> <td>MINIFIT MALE END FITTING</td> <td>2.000</td> <td>PC</td> </tr> <tr> <td>CE1745A0</td> <td>2 WAYS FEMALE MINIFIT CONNECTOR</td> <td>1.000</td> <td>PC</td> </tr> <tr> <td>CE1750A0</td> <td>3 WAYS MALE MINIFIT CONNECTOR</td> <td>1.000</td> <td>PC</td> </tr> <tr> <td>LP1044A0</td> <td>LUX LED BAR</td> <td>1.000</td> <td>PC</td> </tr> </tbody> </table>   | Code | Description | Qty | UOM | CE1455A0 | TIP END FITTING       | 2.000 | PC | CE1730A0 | PVC CABLE NP 2 X AWG22 STYLE 2095 | 1.000 | M  | CE1735A0 | MINIFIT FEMALE END FITTING             | 2.000 | PC | CE1740A0 | MINIFIT MALE END FITTING | 2.000 | PC | CE1745A0 | 2 WAYS FEMALE MINIFIT CONNECTOR | 1.000 | PC | CE1750A0 | 3 WAYS MALE MINIFIT CONNECTOR | 1.000 | PC | LP1044A0 | LUX LED BAR | 1.000 | PC |          |                       |       |    |          |                       |       |    |
| Code      | Description                            | Qty   | UOM        |                               |   |      |             |     |     |          |                       |       |    |          |                                   |       |    |          |  |       |    |          |                          |       |    |          |                                 |       |    |          |                               |       |    |          |             |       |    |          |                       |       |    |          |                       |       |    |
| CE1455A0  | TIP END FITTING                        | 2.000   | PC         |                               |   |      |             |     |     |          |                       |       |    |          |                                   |       |    |          |  |       |    |          |                          |       |    |          |                                 |       |    |          |                               |       |    |          |             |       |    |          |                       |       |    |          |                       |       |    |
| CE1730A0  | PVC CABLE NP 2 X AWG22 STYLE 2095      | 1.000   | M          |                               |   |      |             |     |     |          |                       |       |    |          |                                   |       |    |          |  |       |    |          |                          |       |    |          |                                 |       |    |          |                               |       |    |          |             |       |    |          |                       |       |    |          |                       |       |    |
| CE1735A0  | MINIFIT FEMALE END FITTING             | 2.000   | PC         |                               |   |      |             |     |     |          |                       |       |    |          |                                   |       |    |          |  |       |    |          |                          |       |    |          |                                 |       |    |          |                               |       |    |          |             |       |    |          |                       |       |    |          |                       |       |    |
| CE1740A0  | MINIFIT MALE END FITTING               | 2.000   | PC         |                               |   |      |             |     |     |          |                       |       |    |          |                                   |       |    |          |  |       |    |          |                          |       |    |          |                                 |       |    |          |                               |       |    |          |             |       |    |          |                       |       |    |          |                       |       |    |
| CE1745A0  | 2 WAYS FEMALE MINIFIT CONNECTOR        | 1.000   | PC         |                               |   |      |             |     |     |          |                       |       |    |          |                                   |       |    |          |  |       |    |          |                          |       |    |          |                                 |       |    |          |                               |       |    |          |             |       |    |          |                       |       |    |          |                       |       |    |
| CE1750A0  | 3 WAYS MALE MINIFIT CONNECTOR          | 1.000   | PC         |                               |   |      |             |     |     |          |                       |       |    |          |                                   |       |    |          |  |       |    |          |                          |       |    |          |                                 |       |    |          |                               |       |    |          |             |       |    |          |                       |       |    |          |                       |       |    |
| LP1044A0  | LUX LED BAR                            | 1.000   | PC         |                               |   |      |             |     |     |          |                       |       |    |          |                                   |       |    |          |  |       |    |          |                          |       |    |          |                                 |       |    |          |                               |       |    |          |             |       |    |          |                       |       |    |          |                       |       |    |



| COMPONENT |                                   |  | SPARE PART |                       |   |      |             |                                   |       |          |                       |                                   |       |          |                       |                            |       |    |          |                                 |       |    |          |                                 |       |    |          |                               |       |    |          |                       |       |    |          |                       |       |    |          |                       |       |    |
|-----------|-----------------------------------|--|------------|-----------------------|---|------|-------------|-----------------------------------|-------|----------|-----------------------|-----------------------------------|-------|----------|-----------------------|----------------------------|-------|----|----------|---------------------------------|-------|----|----------|---------------------------------|-------|----|----------|-------------------------------|-------|----|----------|-----------------------|-------|----|----------|-----------------------|-------|----|----------|-----------------------|-------|----|
| Code      | Description                       | Image  | Code       | Description           | Kit components  |      |             |                                   |       |          |                       |                                   |       |          |                       |                            |       |    |          |                                 |       |    |          |                                 |       |    |          |                               |       |    |          |                       |       |    |          |                       |       |    |          |                       |       |    |
| VM1620A   | LED BAR LOWER SUPPORT             |   | KLP1044A   | LUX LED BAR KIT       | <table border="1"> <thead> <tr> <th>Code</th> <th>Description</th> <th>Qty</th> <th>UOM</th> </tr> </thead> <tbody> <tr> <td>VM1620A0</td> <td>LED BAR LOWER SUPPORT</td> <td>1.000</td> <td>PC</td> </tr> <tr> <td>VM1621A0</td> <td>LED BAR UPPER SUPPORT</td> <td>1.000</td> <td>PC</td> </tr> </tbody> </table> | Code | Description | Qty                               | UOM   | VM1620A0 | LED BAR LOWER SUPPORT | 1.000                             | PC    | VM1621A0 | LED BAR UPPER SUPPORT | 1.000                      | PC    |    |          |                                 |       |    |          |                                 |       |    |          |                               |       |    |          |                       |       |    |          |                       |       |    |          |                       |       |    |
|           |                                   |  | Code       | Description           | Qty   | UOM  |             |                                   |       |          |                       |                                   |       |          |                       |                            |       |    |          |                                 |       |    |          |                                 |       |    |          |                               |       |    |          |                       |       |    |          |                       |       |    |          |                       |       |    |
|           |                                   |  | VM1620A0   | LED BAR LOWER SUPPORT | 1.000   | PC   |             |                                   |       |          |                       |                                   |       |          |                       |                            |       |    |          |                                 |       |    |          |                                 |       |    |          |                               |       |    |          |                       |       |    |          |                       |       |    |          |                       |       |    |
| VM1621A0  | LED BAR UPPER SUPPORT             | 1.000  | PC         |                       |   |      |             |                                   |       |          |                       |                                   |       |          |                       |                            |       |    |          |                                 |       |    |          |                                 |       |    |          |                               |       |    |          |                       |       |    |          |                       |       |    |          |                       |       |    |
| KLP1007A  | L200 LED BAR KIT                  | <table border="1"> <thead> <tr> <th>Code</th> <th>Description</th> <th>Qty</th> <th>UOM</th> </tr> </thead> <tbody> <tr> <td>CE1455A0</td> <td>TIP END FITTING</td> <td>2.000</td> <td>PC</td> </tr> <tr> <td>CE1730A0</td> <td>PVC CABLE NP 2 X AWG22 STYLE 2095</td> <td>1.000</td> <td>M</td> </tr> <tr> <td>CE1735A0</td> <td>MINIFIT FEMALE END FITTING</td> <td>2.000</td> <td>PC</td> </tr> <tr> <td>CE1740A0</td> <td>MINIFIT MALE END FITTING</td> <td>2.000</td> <td>PC</td> </tr> <tr> <td>CE1745A0</td> <td>2 WAYS FEMALE MINIFIT CONNECTOR</td> <td>1.000</td> <td>PC</td> </tr> <tr> <td>CE1750A0</td> <td>3 WAYS MALE MINIFIT CONNECTOR</td> <td>1.000</td> <td>PC</td> </tr> <tr> <td>LP1007A0</td> <td>LED LIGHT BAR L200</td> <td>1.000</td> <td>PC</td> </tr> <tr> <td>VM1620A0</td> <td>LED BAR LOWER SUPPORT</td> <td>1.000</td> <td>PC</td> </tr> <tr> <td>VM1621A0</td> <td>LED BAR UPPER SUPPORT</td> <td>1.000</td> <td>PC</td> </tr> </tbody> </table> | Code       | Description           | Qty   | UOM  | CE1455A0    | TIP END FITTING                   | 2.000 | PC       | CE1730A0              | PVC CABLE NP 2 X AWG22 STYLE 2095 | 1.000 | M        | CE1735A0              | MINIFIT FEMALE END FITTING | 2.000 | PC | CE1740A0 | MINIFIT MALE END FITTING        | 2.000 | PC | CE1745A0 | 2 WAYS FEMALE MINIFIT CONNECTOR | 1.000 | PC | CE1750A0 | 3 WAYS MALE MINIFIT CONNECTOR | 1.000 | PC | LP1007A0 | LED LIGHT BAR L200    | 1.000 | PC | VM1620A0 | LED BAR LOWER SUPPORT | 1.000 | PC | VM1621A0 | LED BAR UPPER SUPPORT | 1.000 | PC |
| Code      | Description                       | Qty  | UOM        |                       |   |      |             |                                   |       |          |                       |                                   |       |          |                       |                            |       |    |          |                                 |       |    |          |                                 |       |    |          |                               |       |    |          |                       |       |    |          |                       |       |    |          |                       |       |    |
| CE1455A0  | TIP END FITTING                   | 2.000  | PC         |                       |   |      |             |                                   |       |          |                       |                                   |       |          |                       |                            |       |    |          |                                 |       |    |          |                                 |       |    |          |                               |       |    |          |                       |       |    |          |                       |       |    |          |                       |       |    |
| CE1730A0  | PVC CABLE NP 2 X AWG22 STYLE 2095 | 1.000  | M          |                       |   |      |             |                                   |       |          |                       |                                   |       |          |                       |                            |       |    |          |                                 |       |    |          |                                 |       |    |          |                               |       |    |          |                       |       |    |          |                       |       |    |          |                       |       |    |
| CE1735A0  | MINIFIT FEMALE END FITTING        | 2.000  | PC         |                       |   |      |             |                                   |       |          |                       |                                   |       |          |                       |                            |       |    |          |                                 |       |    |          |                                 |       |    |          |                               |       |    |          |                       |       |    |          |                       |       |    |          |                       |       |    |
| CE1740A0  | MINIFIT MALE END FITTING          | 2.000  | PC         |                       |   |      |             |                                   |       |          |                       |                                   |       |          |                       |                            |       |    |          |                                 |       |    |          |                                 |       |    |          |                               |       |    |          |                       |       |    |          |                       |       |    |          |                       |       |    |
| CE1745A0  | 2 WAYS FEMALE MINIFIT CONNECTOR   | 1.000  | PC         |                       |   |      |             |                                   |       |          |                       |                                   |       |          |                       |                            |       |    |          |                                 |       |    |          |                                 |       |    |          |                               |       |    |          |                       |       |    |          |                       |       |    |          |                       |       |    |
| CE1750A0  | 3 WAYS MALE MINIFIT CONNECTOR     | 1.000  | PC         |                       |   |      |             |                                   |       |          |                       |                                   |       |          |                       |                            |       |    |          |                                 |       |    |          |                                 |       |    |          |                               |       |    |          |                       |       |    |          |                       |       |    |          |                       |       |    |
| LP1007A0  | LED LIGHT BAR L200                | 1.000  | PC         |                       |   |      |             |                                   |       |          |                       |                                   |       |          |                       |                            |       |    |          |                                 |       |    |          |                                 |       |    |          |                               |       |    |          |                       |       |    |          |                       |       |    |          |                       |       |    |
| VM1620A0  | LED BAR LOWER SUPPORT             | 1.000  | PC         |                       |   |      |             |                                   |       |          |                       |                                   |       |          |                       |                            |       |    |          |                                 |       |    |          |                                 |       |    |          |                               |       |    |          |                       |       |    |          |                       |       |    |          |                       |       |    |
| VM1621A0  | LED BAR UPPER SUPPORT             | 1.000  | PC         |                       |   |      |             |                                   |       |          |                       |                                   |       |          |                       |                            |       |    |          |                                 |       |    |          |                                 |       |    |          |                               |       |    |          |                       |       |    |          |                       |       |    |          |                       |       |    |
| KLP1004B  | L1000 LED BAR KIT                 | <table border="1"> <thead> <tr> <th>Code</th> <th>Description</th> <th>Qty</th> <th>UOM</th> </tr> </thead> <tbody> <tr> <td>CE1730A0</td> <td>PVC CABLE NP 2 X AWG22 STYLE 2095</td> <td>1.000</td> <td>M</td> </tr> <tr> <td>CE1735A0</td> <td>MINIFIT FEMALE END FITTING</td> <td>2.000</td> <td>PC</td> </tr> <tr> <td>CE1740A0</td> <td>MINIFIT MALE END FITTING</td> <td>2.000</td> <td>PC</td> </tr> <tr> <td>CE1745A0</td> <td>2 WAYS FEMALE MINIFIT CONNECTOR</td> <td>1.000</td> <td>PC</td> </tr> <tr> <td>CE1750A0</td> <td>3 WAYS MALE MINIFIT CONNECTOR</td> <td>1.000</td> <td>PC</td> </tr> <tr> <td>LP1004B0</td> <td>LEB LIGHTING BAR L1000</td> <td>1.000</td> <td>PC</td> </tr> <tr> <td>VM1620A0</td> <td>LED BAR LOWER SUPPORT</td> <td>1.000</td> <td>PC</td> </tr> <tr> <td>VM1621A0</td> <td>LED BAR UPPER SUPPORT</td> <td>1.000</td> <td>PC</td> </tr> </tbody> </table>  | Code       | Description           | Qty   | UOM  | CE1730A0    | PVC CABLE NP 2 X AWG22 STYLE 2095 | 1.000 | M        | CE1735A0              | MINIFIT FEMALE END FITTING        | 2.000 | PC       | CE1740A0              | MINIFIT MALE END FITTING   | 2.000 | PC | CE1745A0 | 2 WAYS FEMALE MINIFIT CONNECTOR | 1.000 | PC | CE1750A0 | 3 WAYS MALE MINIFIT CONNECTOR   | 1.000 | PC | LP1004B0 | LEB LIGHTING BAR L1000        | 1.000 | PC | VM1620A0 | LED BAR LOWER SUPPORT | 1.000 | PC | VM1621A0 | LED BAR UPPER SUPPORT | 1.000 | PC |          |                       |       |    |
| Code      | Description                       | Qty  | UOM        |                       |   |      |             |                                   |       |          |                       |                                   |       |          |                       |                            |       |    |          |                                 |       |    |          |                                 |       |    |          |                               |       |    |          |                       |       |    |          |                       |       |    |          |                       |       |    |
| CE1730A0  | PVC CABLE NP 2 X AWG22 STYLE 2095 | 1.000  | M          |                       |   |      |             |                                   |       |          |                       |                                   |       |          |                       |                            |       |    |          |                                 |       |    |          |                                 |       |    |          |                               |       |    |          |                       |       |    |          |                       |       |    |          |                       |       |    |
| CE1735A0  | MINIFIT FEMALE END FITTING        | 2.000  | PC         |                       |   |      |             |                                   |       |          |                       |                                   |       |          |                       |                            |       |    |          |                                 |       |    |          |                                 |       |    |          |                               |       |    |          |                       |       |    |          |                       |       |    |          |                       |       |    |
| CE1740A0  | MINIFIT MALE END FITTING          | 2.000  | PC         |                       |   |      |             |                                   |       |          |                       |                                   |       |          |                       |                            |       |    |          |                                 |       |    |          |                                 |       |    |          |                               |       |    |          |                       |       |    |          |                       |       |    |          |                       |       |    |
| CE1745A0  | 2 WAYS FEMALE MINIFIT CONNECTOR   | 1.000  | PC         |                       |   |      |             |                                   |       |          |                       |                                   |       |          |                       |                            |       |    |          |                                 |       |    |          |                                 |       |    |          |                               |       |    |          |                       |       |    |          |                       |       |    |          |                       |       |    |
| CE1750A0  | 3 WAYS MALE MINIFIT CONNECTOR     | 1.000  | PC         |                       |   |      |             |                                   |       |          |                       |                                   |       |          |                       |                            |       |    |          |                                 |       |    |          |                                 |       |    |          |                               |       |    |          |                       |       |    |          |                       |       |    |          |                       |       |    |
| LP1004B0  | LEB LIGHTING BAR L1000            | 1.000  | PC         |                       |   |      |             |                                   |       |          |                       |                                   |       |          |                       |                            |       |    |          |                                 |       |    |          |                                 |       |    |          |                               |       |    |          |                       |       |    |          |                       |       |    |          |                       |       |    |
| VM1620A0  | LED BAR LOWER SUPPORT             | 1.000  | PC         |                       |   |      |             |                                   |       |          |                       |                                   |       |          |                       |                            |       |    |          |                                 |       |    |          |                                 |       |    |          |                               |       |    |          |                       |       |    |          |                       |       |    |          |                       |       |    |
| VM1621A0  | LED BAR UPPER SUPPORT             | 1.000  | PC         |                       |   |      |             |                                   |       |          |                       |                                   |       |          |                       |                            |       |    |          |                                 |       |    |          |                                 |       |    |          |                               |       |    |          |                       |       |    |          |                       |       |    |          |                       |       |    |







| COMPONENT |  |   | SPARE PART |                  |   |      |             |                    |       |          |   |   |       |          |                                  |                                  |       |          |                             |                             |       |          |  |  |       |          |                                     |                                     |       |          |                       |                          |       |          |                             |                             |       |          |                             |                             |       |          |                             |       |    |          |            |       |    |
|-----------|--|---|------------|------------------|---|------|-------------|--------------------|-------|----------|---|---|-------|----------|----------------------------------|----------------------------------|-------|----------|-----------------------------|-----------------------------|-------|----------|--|--|-------|----------|-------------------------------------|-------------------------------------|-------|----------|-----------------------|--------------------------|-------|----------|-----------------------------|-----------------------------|-------|----------|-----------------------------|-----------------------------|-------|----------|-----------------------------|-------|----|----------|------------|-------|----|
| Code      | Description                              | Image   | Code       | Description      | Kit components  |      |             |                    |       |          |   |   |       |          |                                  |                                  |       |          |                             |                             |       |          |  |  |       |          |                                     |                                     |       |          |                       |                          |       |          |                             |                             |       |          |                             |                             |       |          |                             |       |    |          |            |       |    |
| VM1620A   | LED BAR LOWER SUPPORT                    |    | KLP1003B   | 2017 LED BAR KIT | <table border="1"> <thead> <tr> <th>Code</th> <th>Description</th> <th>Qty</th> <th>UOM</th> </tr> </thead> <tbody> <tr> <td>CE1730A0</td> <td>PVC CABLE NP<br/>2 X AWG22<br/>STYLE 2095</td> <td>1.000</td> <td>M</td> </tr> <tr> <td>CE1735A0</td> <td>MINIFIT<br/>FEMALE END<br/>FITTING</td> <td>2.000</td> <td>PC</td> </tr> <tr> <td>CE1740A0</td> <td>MINIFIT MALE<br/>END FITTING</td> <td>2.000</td> <td>PC</td> </tr> <tr> <td>CE1745A0</td> <td>2 WAYS<br/>FEMALE<br/>MINIFIT<br/>CONNECTOR</td> <td>1.000</td> <td>PC</td> </tr> <tr> <td>CE1750A0</td> <td>3 WAYS MALE<br/>MINIFIT<br/>CONNECTOR</td> <td>1.000</td> <td>PC</td> </tr> <tr> <td>LP1003B0</td> <td>LED LIGHT<br/>BAR L600</td> <td>1.000</td> <td>PC</td> </tr> <tr> <td>VM1620A0</td> <td>LED BAR<br/>LOWER<br/>SUPPORT</td> <td>1.000</td> <td>PC</td> </tr> <tr> <td>VM1621A0</td> <td>LED BAR<br/>UPPER<br/>SUPPORT</td> <td>1.000</td> <td>PC</td> </tr> <tr> <td>VM1794A0</td> <td>250x4.8 PA66<br/>BLACK CLAMP</td> <td>2.000</td> <td>PC</td> </tr> <tr> <td>VM2103A0</td> <td>CLAMP LOCK</td> <td>2.000</td> <td>PC</td> </tr> </tbody> </table> | Code | Description | Qty                | UOM   | CE1730A0 | PVC CABLE NP<br>2 X AWG22<br>STYLE 2095 | 1.000                                   | M     | CE1735A0 | MINIFIT<br>FEMALE END<br>FITTING | 2.000                            | PC    | CE1740A0 | MINIFIT MALE<br>END FITTING | 2.000                       | PC    | CE1745A0 | 2 WAYS<br>FEMALE<br>MINIFIT<br>CONNECTOR | 1.000                                    | PC    | CE1750A0 | 3 WAYS MALE<br>MINIFIT<br>CONNECTOR | 1.000                               | PC    | LP1003B0 | LED LIGHT<br>BAR L600 | 1.000                    | PC    | VM1620A0 | LED BAR<br>LOWER<br>SUPPORT | 1.000                       | PC    | VM1621A0 | LED BAR<br>UPPER<br>SUPPORT | 1.000                       | PC    | VM1794A0 | 250x4.8 PA66<br>BLACK CLAMP | 2.000 | PC | VM2103A0 | CLAMP LOCK | 2.000 | PC |
|           |  |   | Code       | Description      | Qty   | UOM  |             |                    |       |          |   |   |       |          |                                  |                                  |       |          |                             |                             |       |          |  |  |       |          |                                     |                                     |       |          |                       |                          |       |          |                             |                             |       |          |                             |                             |       |          |                             |       |    |          |            |       |    |
| CE1730A0  | PVC CABLE NP<br>2 X AWG22<br>STYLE 2095  | 1.000   | M          |                  |   |      |             |                    |       |          |   |   |       |          |                                  |                                  |       |          |                             |                             |       |          |  |  |       |          |                                     |                                     |       |          |                       |                          |       |          |                             |                             |       |          |                             |                             |       |          |                             |       |    |          |            |       |    |
| CE1735A0  | MINIFIT<br>FEMALE END<br>FITTING         | 2.000   | PC         |                  |   |      |             |                    |       |          |   |   |       |          |                                  |                                  |       |          |                             |                             |       |          |  |  |       |          |                                     |                                     |       |          |                       |                          |       |          |                             |                             |       |          |                             |                             |       |          |                             |       |    |          |            |       |    |
| CE1740A0  | MINIFIT MALE<br>END FITTING              | 2.000   | PC         |                  |   |      |             |                    |       |          |   |   |       |          |                                  |                                  |       |          |                             |                             |       |          |  |  |       |          |                                     |                                     |       |          |                       |                          |       |          |                             |                             |       |          |                             |                             |       |          |                             |       |    |          |            |       |    |
| CE1745A0  | 2 WAYS<br>FEMALE<br>MINIFIT<br>CONNECTOR | 1.000   | PC         |                  |   |      |             |                    |       |          |   |   |       |          |                                  |                                  |       |          |                             |                             |       |          |  |  |       |          |                                     |                                     |       |          |                       |                          |       |          |                             |                             |       |          |                             |                             |       |          |                             |       |    |          |            |       |    |
| CE1750A0  | 3 WAYS MALE<br>MINIFIT<br>CONNECTOR      | 1.000   | PC         |                  |   |      |             |                    |       |          |   |   |       |          |                                  |                                  |       |          |                             |                             |       |          |  |  |       |          |                                     |                                     |       |          |                       |                          |       |          |                             |                             |       |          |                             |                             |       |          |                             |       |    |          |            |       |    |
| LP1003B0  | LED LIGHT<br>BAR L600                    | 1.000   | PC         |                  |   |      |             |                    |       |          |   |   |       |          |                                  |                                  |       |          |                             |                             |       |          |  |  |       |          |                                     |                                     |       |          |                       |                          |       |          |                             |                             |       |          |                             |                             |       |          |                             |       |    |          |            |       |    |
| VM1620A0  | LED BAR<br>LOWER<br>SUPPORT              | 1.000   | PC         |                  |   |      |             |                    |       |          |   |   |       |          |                                  |                                  |       |          |                             |                             |       |          |  |  |       |          |                                     |                                     |       |          |                       |                          |       |          |                             |                             |       |          |                             |                             |       |          |                             |       |    |          |            |       |    |
| VM1621A0  | LED BAR<br>UPPER<br>SUPPORT              | 1.000   | PC         |                  |   |      |             |                    |       |          |   |   |       |          |                                  |                                  |       |          |                             |                             |       |          |  |  |       |          |                                     |                                     |       |          |                       |                          |       |          |                             |                             |       |          |                             |                             |       |          |                             |       |    |          |            |       |    |
| VM1794A0  | 250x4.8 PA66<br>BLACK CLAMP              | 2.000   | PC         |                  |   |      |             |                    |       |          |   |   |       |          |                                  |                                  |       |          |                             |                             |       |          |  |  |       |          |                                     |                                     |       |          |                       |                          |       |          |                             |                             |       |          |                             |                             |       |          |                             |       |    |          |            |       |    |
| VM2103A0  | CLAMP LOCK                               | 2.000   | PC         |                  |   |      |             |                    |       |          |   |   |       |          |                                  |                                  |       |          |                             |                             |       |          |  |  |       |          |                                     |                                     |       |          |                       |                          |       |          |                             |                             |       |          |                             |                             |       |          |                             |       |    |          |            |       |    |
| KLP1002B  | L400 LED BAR KIT                         | <table border="1"> <thead> <tr> <th>Code</th> <th>Description</th> <th>Qty</th> <th>UOM</th> </tr> </thead> <tbody> <tr> <td>CE1455A0</td> <td>TIP END<br/>FITTING</td> <td>2.000</td> <td>PC</td> </tr> <tr> <td>CE1730A0</td> <td>PVC CABLE NP<br/>2 X AWG22<br/>STYLE 2095</td> <td>1.000</td> <td>M</td> </tr> <tr> <td>CE1735A0</td> <td>MINIFIT<br/>FEMALE END<br/>FITTING</td> <td>2.000</td> <td>PC</td> </tr> <tr> <td>CE1740A0</td> <td>MINIFIT MALE<br/>END FITTING</td> <td>2.000</td> <td>PC</td> </tr> <tr> <td>CE1745A0</td> <td>2 WAYS<br/>FEMALE<br/>MINIFIT<br/>CONNECTOR</td> <td>1.000</td> <td>PC</td> </tr> <tr> <td>CE1750A0</td> <td>3 WAYS MALE<br/>MINIFIT<br/>CONNECTOR</td> <td>1.000</td> <td>PC</td> </tr> <tr> <td>LP1002B0</td> <td>LED LIGHTING<br/>BAR L400</td> <td>1.000</td> <td>PC</td> </tr> <tr> <td>VM1620A0</td> <td>LED BAR<br/>LOWER<br/>SUPPORT</td> <td>1.000</td> <td>PC</td> </tr> <tr> <td>VM1621A0</td> <td>LED BAR<br/>UPPER<br/>SUPPORT</td> <td>1.000</td> <td>PC</td> </tr> </tbody> </table> | Code       | Description      | Qty   | UOM  | CE1455A0    | TIP END<br>FITTING | 2.000 | PC       | CE1730A0                                | PVC CABLE NP<br>2 X AWG22<br>STYLE 2095 | 1.000 | M        | CE1735A0                         | MINIFIT<br>FEMALE END<br>FITTING | 2.000 | PC       | CE1740A0                    | MINIFIT MALE<br>END FITTING | 2.000 | PC       | CE1745A0                                 | 2 WAYS<br>FEMALE<br>MINIFIT<br>CONNECTOR | 1.000 | PC       | CE1750A0                            | 3 WAYS MALE<br>MINIFIT<br>CONNECTOR | 1.000 | PC       | LP1002B0              | LED LIGHTING<br>BAR L400 | 1.000 | PC       | VM1620A0                    | LED BAR<br>LOWER<br>SUPPORT | 1.000 | PC       | VM1621A0                    | LED BAR<br>UPPER<br>SUPPORT | 1.000 | PC       |                             |       |    |          |            |       |    |
| Code      | Description                              | Qty   | UOM        |                  |   |      |             |                    |       |          |   |   |       |          |                                  |                                  |       |          |                             |                             |       |          |  |  |       |          |                                     |                                     |       |          |                       |                          |       |          |                             |                             |       |          |                             |                             |       |          |                             |       |    |          |            |       |    |
| CE1455A0  | TIP END<br>FITTING                       | 2.000   | PC         |                  |   |      |             |                    |       |          |   |   |       |          |                                  |                                  |       |          |                             |                             |       |          |  |  |       |          |                                     |                                     |       |          |                       |                          |       |          |                             |                             |       |          |                             |                             |       |          |                             |       |    |          |            |       |    |
| CE1730A0  | PVC CABLE NP<br>2 X AWG22<br>STYLE 2095  | 1.000   | M          |                  |   |      |             |                    |       |          |   |   |       |          |                                  |                                  |       |          |                             |                             |       |          |  |  |       |          |                                     |                                     |       |          |                       |                          |       |          |                             |                             |       |          |                             |                             |       |          |                             |       |    |          |            |       |    |
| CE1735A0  | MINIFIT<br>FEMALE END<br>FITTING         | 2.000   | PC         |                  |   |      |             |                    |       |          |   |   |       |          |                                  |                                  |       |          |                             |                             |       |          |  |  |       |          |                                     |                                     |       |          |                       |                          |       |          |                             |                             |       |          |                             |                             |       |          |                             |       |    |          |            |       |    |
| CE1740A0  | MINIFIT MALE<br>END FITTING              | 2.000   | PC         |                  |   |      |             |                    |       |          |   |   |       |          |                                  |                                  |       |          |                             |                             |       |          |  |  |       |          |                                     |                                     |       |          |                       |                          |       |          |                             |                             |       |          |                             |                             |       |          |                             |       |    |          |            |       |    |
| CE1745A0  | 2 WAYS<br>FEMALE<br>MINIFIT<br>CONNECTOR | 1.000   | PC         |                  |   |      |             |                    |       |          |   |   |       |          |                                  |                                  |       |          |                             |                             |       |          |  |  |       |          |                                     |                                     |       |          |                       |                          |       |          |                             |                             |       |          |                             |                             |       |          |                             |       |    |          |            |       |    |
| CE1750A0  | 3 WAYS MALE<br>MINIFIT<br>CONNECTOR      | 1.000   | PC         |                  |   |      |             |                    |       |          |   |   |       |          |                                  |                                  |       |          |                             |                             |       |          |  |  |       |          |                                     |                                     |       |          |                       |                          |       |          |                             |                             |       |          |                             |                             |       |          |                             |       |    |          |            |       |    |
| LP1002B0  | LED LIGHTING<br>BAR L400                 | 1.000   | PC         |                  |   |      |             |                    |       |          |   |   |       |          |                                  |                                  |       |          |                             |                             |       |          |  |  |       |          |                                     |                                     |       |          |                       |                          |       |          |                             |                             |       |          |                             |                             |       |          |                             |       |    |          |            |       |    |
| VM1620A0  | LED BAR<br>LOWER<br>SUPPORT              | 1.000   | PC         |                  |   |      |             |                    |       |          |   |   |       |          |                                  |                                  |       |          |                             |                             |       |          |  |  |       |          |                                     |                                     |       |          |                       |                          |       |          |                             |                             |       |          |                             |                             |       |          |                             |       |    |          |            |       |    |
| VM1621A0  | LED BAR<br>UPPER<br>SUPPORT              | 1.000   | PC         |                  |   |      |             |                    |       |          |   |   |       |          |                                  |                                  |       |          |                             |                             |       |          |  |  |       |          |                                     |                                     |       |          |                       |                          |       |          |                             |                             |       |          |                             |                             |       |          |                             |       |    |          |            |       |    |

| COMPONENT |                                   |  | SPARE PART |                  |   |      |             |                       |       |          |                 |                       |       |          |                                   |                       |       |          |                            |       |    |          |                          |       |    |          |                                 |       |    |          |                               |       |    |          |                       |       |    |          |                       |       |    |          |                       |       |    |
|-----------|-----------------------------------|--|------------|------------------|---|------|-------------|-----------------------|-------|----------|-----------------|-----------------------|-------|----------|-----------------------------------|-----------------------|-------|----------|----------------------------|-------|----|----------|--------------------------|-------|----|----------|---------------------------------|-------|----|----------|-------------------------------|-------|----|----------|-----------------------|-------|----|----------|-----------------------|-------|----|----------|-----------------------|-------|----|
| Code      | Description                       | Image  | Code       | Description      | Kit components  |      |             |                       |       |          |                 |                       |       |          |                                   |                       |       |          |                            |       |    |          |                          |       |    |          |                                 |       |    |          |                               |       |    |          |                       |       |    |          |                       |       |    |          |                       |       |    |
| VM1620A   | LED BAR LOWER SUPPORT             |   | KLP1001B   | L300 LED BAR KIT | <table border="1"> <thead> <tr> <th>Code</th> <th>Description</th> <th>Qty</th> <th>UOM</th> </tr> </thead> <tbody> <tr> <td>CE1455A0</td> <td>TIP END FITTING</td> <td>2.000</td> <td>PC</td> </tr> <tr> <td>CE1730A0</td> <td>PVC CABLE NP 2 X AWG22 STYLE 2095</td> <td>1.000</td> <td>M</td> </tr> <tr> <td>CE1735A0</td> <td>MINIFIT FEMALE END FITTING</td> <td>2.000</td> <td>PC</td> </tr> <tr> <td>CE1740A0</td> <td>MINIFIT MALE END FITTING</td> <td>2.000</td> <td>PC</td> </tr> <tr> <td>CE1745A0</td> <td>2 WAYS FEMALE MINIFIT CONNECTOR</td> <td>1.000</td> <td>PC</td> </tr> <tr> <td>CE1750A0</td> <td>3 WAYS MALE MINIFIT CONNECTOR</td> <td>1.000</td> <td>PC</td> </tr> <tr> <td>LP1001B0</td> <td>LED LIGHTING BAR L300</td> <td>1.000</td> <td>PC</td> </tr> <tr> <td>VM1620A0</td> <td>LED BAR LOWER SUPPORT</td> <td>1.000</td> <td>PC</td> </tr> <tr> <td>VM1621A0</td> <td>LED BAR UPPER SUPPORT</td> <td>1.000</td> <td>PC</td> </tr> </tbody> </table> | Code | Description | Qty                   | UOM   | CE1455A0 | TIP END FITTING | 2.000                 | PC    | CE1730A0 | PVC CABLE NP 2 X AWG22 STYLE 2095 | 1.000                 | M     | CE1735A0 | MINIFIT FEMALE END FITTING | 2.000 | PC | CE1740A0 | MINIFIT MALE END FITTING | 2.000 | PC | CE1745A0 | 2 WAYS FEMALE MINIFIT CONNECTOR | 1.000 | PC | CE1750A0 | 3 WAYS MALE MINIFIT CONNECTOR | 1.000 | PC | LP1001B0 | LED LIGHTING BAR L300 | 1.000 | PC | VM1620A0 | LED BAR LOWER SUPPORT | 1.000 | PC | VM1621A0 | LED BAR UPPER SUPPORT | 1.000 | PC |
|           |                                   |  | Code       | Description      | Qty   | UOM  |             |                       |       |          |                 |                       |       |          |                                   |                       |       |          |                            |       |    |          |                          |       |    |          |                                 |       |    |          |                               |       |    |          |                       |       |    |          |                       |       |    |          |                       |       |    |
| CE1455A0  | TIP END FITTING                   | 2.000  | PC         |                  |   |      |             |                       |       |          |                 |                       |       |          |                                   |                       |       |          |                            |       |    |          |                          |       |    |          |                                 |       |    |          |                               |       |    |          |                       |       |    |          |                       |       |    |          |                       |       |    |
| CE1730A0  | PVC CABLE NP 2 X AWG22 STYLE 2095 | 1.000  | M          |                  |   |      |             |                       |       |          |                 |                       |       |          |                                   |                       |       |          |                            |       |    |          |                          |       |    |          |                                 |       |    |          |                               |       |    |          |                       |       |    |          |                       |       |    |          |                       |       |    |
| CE1735A0  | MINIFIT FEMALE END FITTING        | 2.000  | PC         |                  |   |      |             |                       |       |          |                 |                       |       |          |                                   |                       |       |          |                            |       |    |          |                          |       |    |          |                                 |       |    |          |                               |       |    |          |                       |       |    |          |                       |       |    |          |                       |       |    |
| CE1740A0  | MINIFIT MALE END FITTING          | 2.000  | PC         |                  |   |      |             |                       |       |          |                 |                       |       |          |                                   |                       |       |          |                            |       |    |          |                          |       |    |          |                                 |       |    |          |                               |       |    |          |                       |       |    |          |                       |       |    |          |                       |       |    |
| CE1745A0  | 2 WAYS FEMALE MINIFIT CONNECTOR   | 1.000  | PC         |                  |   |      |             |                       |       |          |                 |                       |       |          |                                   |                       |       |          |                            |       |    |          |                          |       |    |          |                                 |       |    |          |                               |       |    |          |                       |       |    |          |                       |       |    |          |                       |       |    |
| CE1750A0  | 3 WAYS MALE MINIFIT CONNECTOR     | 1.000  | PC         |                  |   |      |             |                       |       |          |                 |                       |       |          |                                   |                       |       |          |                            |       |    |          |                          |       |    |          |                                 |       |    |          |                               |       |    |          |                       |       |    |          |                       |       |    |          |                       |       |    |
| LP1001B0  | LED LIGHTING BAR L300             | 1.000  | PC         |                  |   |      |             |                       |       |          |                 |                       |       |          |                                   |                       |       |          |                            |       |    |          |                          |       |    |          |                                 |       |    |          |                               |       |    |          |                       |       |    |          |                       |       |    |          |                       |       |    |
| VM1620A0  | LED BAR LOWER SUPPORT             | 1.000  | PC         |                  |   |      |             |                       |       |          |                 |                       |       |          |                                   |                       |       |          |                            |       |    |          |                          |       |    |          |                                 |       |    |          |                               |       |    |          |                       |       |    |          |                       |       |    |          |                       |       |    |
| VM1621A0  | LED BAR UPPER SUPPORT             | 1.000  | PC         |                  |   |      |             |                       |       |          |                 |                       |       |          |                                   |                       |       |          |                            |       |    |          |                          |       |    |          |                                 |       |    |          |                               |       |    |          |                       |       |    |          |                       |       |    |          |                       |       |    |
| KLP1000A  | L100 LED BAR KIT                  | <table border="1"> <thead> <tr> <th>Code</th> <th>Description</th> <th>Qty</th> <th>UOM</th> </tr> </thead> <tbody> <tr> <td>LP1000A0</td> <td>LED LIGHTING BAR L100</td> <td>1.000</td> <td>PC</td> </tr> <tr> <td>VM1620A0</td> <td>LED BAR LOWER SUPPORT</td> <td>1.000</td> <td>PC</td> </tr> <tr> <td>VM1621A0</td> <td>LED BAR UPPER SUPPORT</td> <td>1.000</td> <td>PC</td> </tr> </tbody> </table> | Code       | Description      | Qty   | UOM  | LP1000A0    | LED LIGHTING BAR L100 | 1.000 | PC       | VM1620A0        | LED BAR LOWER SUPPORT | 1.000 | PC       | VM1621A0                          | LED BAR UPPER SUPPORT | 1.000 | PC       |                            |       |    |          |                          |       |    |          |                                 |       |    |          |                               |       |    |          |                       |       |    |          |                       |       |    |          |                       |       |    |
| Code      | Description                       | Qty  | UOM        |                  |   |      |             |                       |       |          |                 |                       |       |          |                                   |                       |       |          |                            |       |    |          |                          |       |    |          |                                 |       |    |          |                               |       |    |          |                       |       |    |          |                       |       |    |          |                       |       |    |
| LP1000A0  | LED LIGHTING BAR L100             | 1.000  | PC         |                  |   |      |             |                       |       |          |                 |                       |       |          |                                   |                       |       |          |                            |       |    |          |                          |       |    |          |                                 |       |    |          |                               |       |    |          |                       |       |    |          |                       |       |    |          |                       |       |    |
| VM1620A0  | LED BAR LOWER SUPPORT             | 1.000  | PC         |                  |   |      |             |                       |       |          |                 |                       |       |          |                                   |                       |       |          |                            |       |    |          |                          |       |    |          |                                 |       |    |          |                               |       |    |          |                       |       |    |          |                       |       |    |          |                       |       |    |
| VM1621A0  | LED BAR UPPER SUPPORT             | 1.000  | PC         |                  |   |      |             |                       |       |          |                 |                       |       |          |                                   |                       |       |          |                            |       |    |          |                          |       |    |          |                                 |       |    |          |                               |       |    |          |                       |       |    |          |                       |       |    |          |                       |       |    |
| VM1621A   | LED BAR UPPER SUPPORT             |   | KLP1044A   | LUX LED BAR KIT  | <table border="1"> <thead> <tr> <th>Code</th> <th>Description</th> <th>Qty</th> <th>UOM</th> </tr> </thead> <tbody> <tr> <td>CE1455A0</td> <td>TIP END FITTING</td> <td>2.000</td> <td>PC</td> </tr> <tr> <td>CE1730A0</td> <td>PVC CABLE NP 2 X AWG22 STYLE 2095</td> <td>1.000</td> <td>M</td> </tr> <tr> <td>CE1735A0</td> <td>MINIFIT FEMALE END FITTING</td> <td>2.000</td> <td>PC</td> </tr> <tr> <td>CE1740A0</td> <td>MINIFIT MALE END FITTING</td> <td>2.000</td> <td>PC</td> </tr> <tr> <td>CE1745A0</td> <td>2 WAYS FEMALE MINIFIT CONNECTOR</td> <td>1.000</td> <td>PC</td> </tr> <tr> <td>CE1750A0</td> <td>3 WAYS MALE MINIFIT CONNECTOR</td> <td>1.000</td> <td>PC</td> </tr> <tr> <td>LP1044A0</td> <td>LUX LED BAR</td> <td>1.000</td> <td>PC</td> </tr> </tbody> </table>   | Code | Description | Qty                   | UOM   | CE1455A0 | TIP END FITTING | 2.000                 | PC    | CE1730A0 | PVC CABLE NP 2 X AWG22 STYLE 2095 | 1.000                 | M     | CE1735A0 | MINIFIT FEMALE END FITTING | 2.000 | PC | CE1740A0 | MINIFIT MALE END FITTING | 2.000 | PC | CE1745A0 | 2 WAYS FEMALE MINIFIT CONNECTOR | 1.000 | PC | CE1750A0 | 3 WAYS MALE MINIFIT CONNECTOR | 1.000 | PC | LP1044A0 | LUX LED BAR           | 1.000 | PC |          |                       |       |    |          |                       |       |    |
|           |                                   |  | Code       | Description      | Qty   | UOM  |             |                       |       |          |                 |                       |       |          |                                   |                       |       |          |                            |       |    |          |                          |       |    |          |                                 |       |    |          |                               |       |    |          |                       |       |    |          |                       |       |    |          |                       |       |    |
| CE1455A0  | TIP END FITTING                   | 2.000  | PC         |                  |   |      |             |                       |       |          |                 |                       |       |          |                                   |                       |       |          |                            |       |    |          |                          |       |    |          |                                 |       |    |          |                               |       |    |          |                       |       |    |          |                       |       |    |          |                       |       |    |
| CE1730A0  | PVC CABLE NP 2 X AWG22 STYLE 2095 | 1.000  | M          |                  |   |      |             |                       |       |          |                 |                       |       |          |                                   |                       |       |          |                            |       |    |          |                          |       |    |          |                                 |       |    |          |                               |       |    |          |                       |       |    |          |                       |       |    |          |                       |       |    |
| CE1735A0  | MINIFIT FEMALE END FITTING        | 2.000  | PC         |                  |   |      |             |                       |       |          |                 |                       |       |          |                                   |                       |       |          |                            |       |    |          |                          |       |    |          |                                 |       |    |          |                               |       |    |          |                       |       |    |          |                       |       |    |          |                       |       |    |
| CE1740A0  | MINIFIT MALE END FITTING          | 2.000  | PC         |                  |   |      |             |                       |       |          |                 |                       |       |          |                                   |                       |       |          |                            |       |    |          |                          |       |    |          |                                 |       |    |          |                               |       |    |          |                       |       |    |          |                       |       |    |          |                       |       |    |
| CE1745A0  | 2 WAYS FEMALE MINIFIT CONNECTOR   | 1.000  | PC         |                  |   |      |             |                       |       |          |                 |                       |       |          |                                   |                       |       |          |                            |       |    |          |                          |       |    |          |                                 |       |    |          |                               |       |    |          |                       |       |    |          |                       |       |    |          |                       |       |    |
| CE1750A0  | 3 WAYS MALE MINIFIT CONNECTOR     | 1.000  | PC         |                  |   |      |             |                       |       |          |                 |                       |       |          |                                   |                       |       |          |                            |       |    |          |                          |       |    |          |                                 |       |    |          |                               |       |    |          |                       |       |    |          |                       |       |    |          |                       |       |    |
| LP1044A0  | LUX LED BAR                       | 1.000  | PC         |                  |   |      |             |                       |       |          |                 |                       |       |          |                                   |                       |       |          |                            |       |    |          |                          |       |    |          |                                 |       |    |          |                               |       |    |          |                       |       |    |          |                       |       |    |          |                       |       |    |







| COMPONENT |                                   |  | SPARE PART |                       |   |      |             |                                   |       |          |                       |                                   |       |          |                       |                            |       |    |          |                                 |       |    |          |                                 |       |    |          |                               |       |    |          |                       |       |    |          |                       |       |    |          |                       |       |    |
|-----------|-----------------------------------|--|------------|-----------------------|---|------|-------------|-----------------------------------|-------|----------|-----------------------|-----------------------------------|-------|----------|-----------------------|----------------------------|-------|----|----------|---------------------------------|-------|----|----------|---------------------------------|-------|----|----------|-------------------------------|-------|----|----------|-----------------------|-------|----|----------|-----------------------|-------|----|----------|-----------------------|-------|----|
| Code      | Description                       | Image  | Code       | Description           | Kit components  |      |             |                                   |       |          |                       |                                   |       |          |                       |                            |       |    |          |                                 |       |    |          |                                 |       |    |          |                               |       |    |          |                       |       |    |          |                       |       |    |          |                       |       |    |
| VM1621A   | LED BAR UPPER SUPPORT             |   | KLP1044A   | LUX LED BAR KIT       | <table border="1"> <thead> <tr> <th>Code</th> <th>Description</th> <th>Qty</th> <th>UOM</th> </tr> </thead> <tbody> <tr> <td>VM1620A0</td> <td>LED BAR LOWER SUPPORT</td> <td>1.000</td> <td>PC</td> </tr> <tr> <td>VM1621A0</td> <td>LED BAR UPPER SUPPORT</td> <td>1.000</td> <td>PC</td> </tr> </tbody> </table> | Code | Description | Qty                               | UOM   | VM1620A0 | LED BAR LOWER SUPPORT | 1.000                             | PC    | VM1621A0 | LED BAR UPPER SUPPORT | 1.000                      | PC    |    |          |                                 |       |    |          |                                 |       |    |          |                               |       |    |          |                       |       |    |          |                       |       |    |          |                       |       |    |
|           |                                   |  | Code       | Description           | Qty   | UOM  |             |                                   |       |          |                       |                                   |       |          |                       |                            |       |    |          |                                 |       |    |          |                                 |       |    |          |                               |       |    |          |                       |       |    |          |                       |       |    |          |                       |       |    |
|           |                                   |  | VM1620A0   | LED BAR LOWER SUPPORT | 1.000   | PC   |             |                                   |       |          |                       |                                   |       |          |                       |                            |       |    |          |                                 |       |    |          |                                 |       |    |          |                               |       |    |          |                       |       |    |          |                       |       |    |          |                       |       |    |
| VM1621A0  | LED BAR UPPER SUPPORT             | 1.000  | PC         |                       |   |      |             |                                   |       |          |                       |                                   |       |          |                       |                            |       |    |          |                                 |       |    |          |                                 |       |    |          |                               |       |    |          |                       |       |    |          |                       |       |    |          |                       |       |    |
| KLP1007A  | L200 LED BAR KIT                  | <table border="1"> <thead> <tr> <th>Code</th> <th>Description</th> <th>Qty</th> <th>UOM</th> </tr> </thead> <tbody> <tr> <td>CE1455A0</td> <td>TIP END FITTING</td> <td>2.000</td> <td>PC</td> </tr> <tr> <td>CE1730A0</td> <td>PVC CABLE NP 2 X AWG22 STYLE 2095</td> <td>1.000</td> <td>M</td> </tr> <tr> <td>CE1735A0</td> <td>MINIFIT FEMALE END FITTING</td> <td>2.000</td> <td>PC</td> </tr> <tr> <td>CE1740A0</td> <td>MINIFIT MALE END FITTING</td> <td>2.000</td> <td>PC</td> </tr> <tr> <td>CE1745A0</td> <td>2 WAYS FEMALE MINIFIT CONNECTOR</td> <td>1.000</td> <td>PC</td> </tr> <tr> <td>CE1750A0</td> <td>3 WAYS MALE MINIFIT CONNECTOR</td> <td>1.000</td> <td>PC</td> </tr> <tr> <td>LP1007A0</td> <td>LED LIGHT BAR L200</td> <td>1.000</td> <td>PC</td> </tr> <tr> <td>VM1620A0</td> <td>LED BAR LOWER SUPPORT</td> <td>1.000</td> <td>PC</td> </tr> <tr> <td>VM1621A0</td> <td>LED BAR UPPER SUPPORT</td> <td>1.000</td> <td>PC</td> </tr> </tbody> </table> | Code       | Description           | Qty   | UOM  | CE1455A0    | TIP END FITTING                   | 2.000 | PC       | CE1730A0              | PVC CABLE NP 2 X AWG22 STYLE 2095 | 1.000 | M        | CE1735A0              | MINIFIT FEMALE END FITTING | 2.000 | PC | CE1740A0 | MINIFIT MALE END FITTING        | 2.000 | PC | CE1745A0 | 2 WAYS FEMALE MINIFIT CONNECTOR | 1.000 | PC | CE1750A0 | 3 WAYS MALE MINIFIT CONNECTOR | 1.000 | PC | LP1007A0 | LED LIGHT BAR L200    | 1.000 | PC | VM1620A0 | LED BAR LOWER SUPPORT | 1.000 | PC | VM1621A0 | LED BAR UPPER SUPPORT | 1.000 | PC |
| Code      | Description                       | Qty  | UOM        |                       |   |      |             |                                   |       |          |                       |                                   |       |          |                       |                            |       |    |          |                                 |       |    |          |                                 |       |    |          |                               |       |    |          |                       |       |    |          |                       |       |    |          |                       |       |    |
| CE1455A0  | TIP END FITTING                   | 2.000  | PC         |                       |   |      |             |                                   |       |          |                       |                                   |       |          |                       |                            |       |    |          |                                 |       |    |          |                                 |       |    |          |                               |       |    |          |                       |       |    |          |                       |       |    |          |                       |       |    |
| CE1730A0  | PVC CABLE NP 2 X AWG22 STYLE 2095 | 1.000  | M          |                       |   |      |             |                                   |       |          |                       |                                   |       |          |                       |                            |       |    |          |                                 |       |    |          |                                 |       |    |          |                               |       |    |          |                       |       |    |          |                       |       |    |          |                       |       |    |
| CE1735A0  | MINIFIT FEMALE END FITTING        | 2.000  | PC         |                       |   |      |             |                                   |       |          |                       |                                   |       |          |                       |                            |       |    |          |                                 |       |    |          |                                 |       |    |          |                               |       |    |          |                       |       |    |          |                       |       |    |          |                       |       |    |
| CE1740A0  | MINIFIT MALE END FITTING          | 2.000  | PC         |                       |   |      |             |                                   |       |          |                       |                                   |       |          |                       |                            |       |    |          |                                 |       |    |          |                                 |       |    |          |                               |       |    |          |                       |       |    |          |                       |       |    |          |                       |       |    |
| CE1745A0  | 2 WAYS FEMALE MINIFIT CONNECTOR   | 1.000  | PC         |                       |   |      |             |                                   |       |          |                       |                                   |       |          |                       |                            |       |    |          |                                 |       |    |          |                                 |       |    |          |                               |       |    |          |                       |       |    |          |                       |       |    |          |                       |       |    |
| CE1750A0  | 3 WAYS MALE MINIFIT CONNECTOR     | 1.000  | PC         |                       |   |      |             |                                   |       |          |                       |                                   |       |          |                       |                            |       |    |          |                                 |       |    |          |                                 |       |    |          |                               |       |    |          |                       |       |    |          |                       |       |    |          |                       |       |    |
| LP1007A0  | LED LIGHT BAR L200                | 1.000  | PC         |                       |   |      |             |                                   |       |          |                       |                                   |       |          |                       |                            |       |    |          |                                 |       |    |          |                                 |       |    |          |                               |       |    |          |                       |       |    |          |                       |       |    |          |                       |       |    |
| VM1620A0  | LED BAR LOWER SUPPORT             | 1.000  | PC         |                       |   |      |             |                                   |       |          |                       |                                   |       |          |                       |                            |       |    |          |                                 |       |    |          |                                 |       |    |          |                               |       |    |          |                       |       |    |          |                       |       |    |          |                       |       |    |
| VM1621A0  | LED BAR UPPER SUPPORT             | 1.000  | PC         |                       |   |      |             |                                   |       |          |                       |                                   |       |          |                       |                            |       |    |          |                                 |       |    |          |                                 |       |    |          |                               |       |    |          |                       |       |    |          |                       |       |    |          |                       |       |    |
| KLP1004B  | L1000 LED BAR KIT                 | <table border="1"> <thead> <tr> <th>Code</th> <th>Description</th> <th>Qty</th> <th>UOM</th> </tr> </thead> <tbody> <tr> <td>CE1730A0</td> <td>PVC CABLE NP 2 X AWG22 STYLE 2095</td> <td>1.000</td> <td>M</td> </tr> <tr> <td>CE1735A0</td> <td>MINIFIT FEMALE END FITTING</td> <td>2.000</td> <td>PC</td> </tr> <tr> <td>CE1740A0</td> <td>MINIFIT MALE END FITTING</td> <td>2.000</td> <td>PC</td> </tr> <tr> <td>CE1745A0</td> <td>2 WAYS FEMALE MINIFIT CONNECTOR</td> <td>1.000</td> <td>PC</td> </tr> <tr> <td>CE1750A0</td> <td>3 WAYS MALE MINIFIT CONNECTOR</td> <td>1.000</td> <td>PC</td> </tr> <tr> <td>LP1004B0</td> <td>LEB LIGHTING BAR L1000</td> <td>1.000</td> <td>PC</td> </tr> <tr> <td>VM1620A0</td> <td>LED BAR LOWER SUPPORT</td> <td>1.000</td> <td>PC</td> </tr> <tr> <td>VM1621A0</td> <td>LED BAR UPPER SUPPORT</td> <td>1.000</td> <td>PC</td> </tr> </tbody> </table>  | Code       | Description           | Qty   | UOM  | CE1730A0    | PVC CABLE NP 2 X AWG22 STYLE 2095 | 1.000 | M        | CE1735A0              | MINIFIT FEMALE END FITTING        | 2.000 | PC       | CE1740A0              | MINIFIT MALE END FITTING   | 2.000 | PC | CE1745A0 | 2 WAYS FEMALE MINIFIT CONNECTOR | 1.000 | PC | CE1750A0 | 3 WAYS MALE MINIFIT CONNECTOR   | 1.000 | PC | LP1004B0 | LEB LIGHTING BAR L1000        | 1.000 | PC | VM1620A0 | LED BAR LOWER SUPPORT | 1.000 | PC | VM1621A0 | LED BAR UPPER SUPPORT | 1.000 | PC |          |                       |       |    |
| Code      | Description                       | Qty  | UOM        |                       |   |      |             |                                   |       |          |                       |                                   |       |          |                       |                            |       |    |          |                                 |       |    |          |                                 |       |    |          |                               |       |    |          |                       |       |    |          |                       |       |    |          |                       |       |    |
| CE1730A0  | PVC CABLE NP 2 X AWG22 STYLE 2095 | 1.000  | M          |                       |   |      |             |                                   |       |          |                       |                                   |       |          |                       |                            |       |    |          |                                 |       |    |          |                                 |       |    |          |                               |       |    |          |                       |       |    |          |                       |       |    |          |                       |       |    |
| CE1735A0  | MINIFIT FEMALE END FITTING        | 2.000  | PC         |                       |   |      |             |                                   |       |          |                       |                                   |       |          |                       |                            |       |    |          |                                 |       |    |          |                                 |       |    |          |                               |       |    |          |                       |       |    |          |                       |       |    |          |                       |       |    |
| CE1740A0  | MINIFIT MALE END FITTING          | 2.000  | PC         |                       |   |      |             |                                   |       |          |                       |                                   |       |          |                       |                            |       |    |          |                                 |       |    |          |                                 |       |    |          |                               |       |    |          |                       |       |    |          |                       |       |    |          |                       |       |    |
| CE1745A0  | 2 WAYS FEMALE MINIFIT CONNECTOR   | 1.000  | PC         |                       |   |      |             |                                   |       |          |                       |                                   |       |          |                       |                            |       |    |          |                                 |       |    |          |                                 |       |    |          |                               |       |    |          |                       |       |    |          |                       |       |    |          |                       |       |    |
| CE1750A0  | 3 WAYS MALE MINIFIT CONNECTOR     | 1.000  | PC         |                       |   |      |             |                                   |       |          |                       |                                   |       |          |                       |                            |       |    |          |                                 |       |    |          |                                 |       |    |          |                               |       |    |          |                       |       |    |          |                       |       |    |          |                       |       |    |
| LP1004B0  | LEB LIGHTING BAR L1000            | 1.000  | PC         |                       |   |      |             |                                   |       |          |                       |                                   |       |          |                       |                            |       |    |          |                                 |       |    |          |                                 |       |    |          |                               |       |    |          |                       |       |    |          |                       |       |    |          |                       |       |    |
| VM1620A0  | LED BAR LOWER SUPPORT             | 1.000  | PC         |                       |   |      |             |                                   |       |          |                       |                                   |       |          |                       |                            |       |    |          |                                 |       |    |          |                                 |       |    |          |                               |       |    |          |                       |       |    |          |                       |       |    |          |                       |       |    |
| VM1621A0  | LED BAR UPPER SUPPORT             | 1.000  | PC         |                       |   |      |             |                                   |       |          |                       |                                   |       |          |                       |                            |       |    |          |                                 |       |    |          |                                 |       |    |          |                               |       |    |          |                       |       |    |          |                       |       |    |          |                       |       |    |



| COMPONENT |  |   | SPARE PART |                  |   |      |             |                    |       |          |   |   |       |          |                                  |                                  |       |          |                             |                             |       |          |  |  |       |          |                                     |                                     |       |          |                       |                          |       |          |                             |                             |       |          |                             |                             |       |          |                             |       |    |          |            |       |    |
|-----------|--|---|------------|------------------|---|------|-------------|--------------------|-------|----------|---|---|-------|----------|----------------------------------|----------------------------------|-------|----------|-----------------------------|-----------------------------|-------|----------|--|--|-------|----------|-------------------------------------|-------------------------------------|-------|----------|-----------------------|--------------------------|-------|----------|-----------------------------|-----------------------------|-------|----------|-----------------------------|-----------------------------|-------|----------|-----------------------------|-------|----|----------|------------|-------|----|
| Code      | Description                              | Image   | Code       | Description      | Kit components  |      |             |                    |       |          |   |   |       |          |                                  |                                  |       |          |                             |                             |       |          |  |  |       |          |                                     |                                     |       |          |                       |                          |       |          |                             |                             |       |          |                             |                             |       |          |                             |       |    |          |            |       |    |
| VM1621A   | LED BAR UPPER SUPPORT                    |    | KLP1003B   | 2017 LED BAR KIT | <table border="1"> <thead> <tr> <th>Code</th> <th>Description</th> <th>Qty</th> <th>UOM</th> </tr> </thead> <tbody> <tr> <td>CE1730A0</td> <td>PVC CABLE NP<br/>2 X AWG22<br/>STYLE 2095</td> <td>1.000</td> <td>M</td> </tr> <tr> <td>CE1735A0</td> <td>MINIFIT<br/>FEMALE END<br/>FITTING</td> <td>2.000</td> <td>PC</td> </tr> <tr> <td>CE1740A0</td> <td>MINIFIT MALE<br/>END FITTING</td> <td>2.000</td> <td>PC</td> </tr> <tr> <td>CE1745A0</td> <td>2 WAYS<br/>FEMALE<br/>MINIFIT<br/>CONNECTOR</td> <td>1.000</td> <td>PC</td> </tr> <tr> <td>CE1750A0</td> <td>3 WAYS MALE<br/>MINIFIT<br/>CONNECTOR</td> <td>1.000</td> <td>PC</td> </tr> <tr> <td>LP1003B0</td> <td>LED LIGHT<br/>BAR L600</td> <td>1.000</td> <td>PC</td> </tr> <tr> <td>VM1620A0</td> <td>LED BAR<br/>LOWER<br/>SUPPORT</td> <td>1.000</td> <td>PC</td> </tr> <tr> <td>VM1621A0</td> <td>LED BAR<br/>UPPER<br/>SUPPORT</td> <td>1.000</td> <td>PC</td> </tr> <tr> <td>VM1794A0</td> <td>250x4.8 PA66<br/>BLACK CLAMP</td> <td>2.000</td> <td>PC</td> </tr> <tr> <td>VM2103A0</td> <td>CLAMP LOCK</td> <td>2.000</td> <td>PC</td> </tr> </tbody> </table> | Code | Description | Qty                | UOM   | CE1730A0 | PVC CABLE NP<br>2 X AWG22<br>STYLE 2095 | 1.000                                   | M     | CE1735A0 | MINIFIT<br>FEMALE END<br>FITTING | 2.000                            | PC    | CE1740A0 | MINIFIT MALE<br>END FITTING | 2.000                       | PC    | CE1745A0 | 2 WAYS<br>FEMALE<br>MINIFIT<br>CONNECTOR | 1.000                                    | PC    | CE1750A0 | 3 WAYS MALE<br>MINIFIT<br>CONNECTOR | 1.000                               | PC    | LP1003B0 | LED LIGHT<br>BAR L600 | 1.000                    | PC    | VM1620A0 | LED BAR<br>LOWER<br>SUPPORT | 1.000                       | PC    | VM1621A0 | LED BAR<br>UPPER<br>SUPPORT | 1.000                       | PC    | VM1794A0 | 250x4.8 PA66<br>BLACK CLAMP | 2.000 | PC | VM2103A0 | CLAMP LOCK | 2.000 | PC |
|           |  |   | Code       | Description      | Qty   | UOM  |             |                    |       |          |   |   |       |          |                                  |                                  |       |          |                             |                             |       |          |  |  |       |          |                                     |                                     |       |          |                       |                          |       |          |                             |                             |       |          |                             |                             |       |          |                             |       |    |          |            |       |    |
| CE1730A0  | PVC CABLE NP<br>2 X AWG22<br>STYLE 2095  | 1.000   | M          |                  |   |      |             |                    |       |          |   |   |       |          |                                  |                                  |       |          |                             |                             |       |          |  |  |       |          |                                     |                                     |       |          |                       |                          |       |          |                             |                             |       |          |                             |                             |       |          |                             |       |    |          |            |       |    |
| CE1735A0  | MINIFIT<br>FEMALE END<br>FITTING         | 2.000   | PC         |                  |   |      |             |                    |       |          |   |   |       |          |                                  |                                  |       |          |                             |                             |       |          |  |  |       |          |                                     |                                     |       |          |                       |                          |       |          |                             |                             |       |          |                             |                             |       |          |                             |       |    |          |            |       |    |
| CE1740A0  | MINIFIT MALE<br>END FITTING              | 2.000   | PC         |                  |   |      |             |                    |       |          |   |   |       |          |                                  |                                  |       |          |                             |                             |       |          |  |  |       |          |                                     |                                     |       |          |                       |                          |       |          |                             |                             |       |          |                             |                             |       |          |                             |       |    |          |            |       |    |
| CE1745A0  | 2 WAYS<br>FEMALE<br>MINIFIT<br>CONNECTOR | 1.000   | PC         |                  |   |      |             |                    |       |          |   |   |       |          |                                  |                                  |       |          |                             |                             |       |          |  |  |       |          |                                     |                                     |       |          |                       |                          |       |          |                             |                             |       |          |                             |                             |       |          |                             |       |    |          |            |       |    |
| CE1750A0  | 3 WAYS MALE<br>MINIFIT<br>CONNECTOR      | 1.000   | PC         |                  |   |      |             |                    |       |          |   |   |       |          |                                  |                                  |       |          |                             |                             |       |          |  |  |       |          |                                     |                                     |       |          |                       |                          |       |          |                             |                             |       |          |                             |                             |       |          |                             |       |    |          |            |       |    |
| LP1003B0  | LED LIGHT<br>BAR L600                    | 1.000   | PC         |                  |   |      |             |                    |       |          |   |   |       |          |                                  |                                  |       |          |                             |                             |       |          |  |  |       |          |                                     |                                     |       |          |                       |                          |       |          |                             |                             |       |          |                             |                             |       |          |                             |       |    |          |            |       |    |
| VM1620A0  | LED BAR<br>LOWER<br>SUPPORT              | 1.000   | PC         |                  |   |      |             |                    |       |          |   |   |       |          |                                  |                                  |       |          |                             |                             |       |          |  |  |       |          |                                     |                                     |       |          |                       |                          |       |          |                             |                             |       |          |                             |                             |       |          |                             |       |    |          |            |       |    |
| VM1621A0  | LED BAR<br>UPPER<br>SUPPORT              | 1.000   | PC         |                  |   |      |             |                    |       |          |   |   |       |          |                                  |                                  |       |          |                             |                             |       |          |  |  |       |          |                                     |                                     |       |          |                       |                          |       |          |                             |                             |       |          |                             |                             |       |          |                             |       |    |          |            |       |    |
| VM1794A0  | 250x4.8 PA66<br>BLACK CLAMP              | 2.000   | PC         |                  |   |      |             |                    |       |          |   |   |       |          |                                  |                                  |       |          |                             |                             |       |          |  |  |       |          |                                     |                                     |       |          |                       |                          |       |          |                             |                             |       |          |                             |                             |       |          |                             |       |    |          |            |       |    |
| VM2103A0  | CLAMP LOCK                               | 2.000   | PC         |                  |   |      |             |                    |       |          |   |   |       |          |                                  |                                  |       |          |                             |                             |       |          |  |  |       |          |                                     |                                     |       |          |                       |                          |       |          |                             |                             |       |          |                             |                             |       |          |                             |       |    |          |            |       |    |
| KLP1002B  | L400 LED BAR KIT                         | <table border="1"> <thead> <tr> <th>Code</th> <th>Description</th> <th>Qty</th> <th>UOM</th> </tr> </thead> <tbody> <tr> <td>CE1455A0</td> <td>TIP END<br/>FITTING</td> <td>2.000</td> <td>PC</td> </tr> <tr> <td>CE1730A0</td> <td>PVC CABLE NP<br/>2 X AWG22<br/>STYLE 2095</td> <td>1.000</td> <td>M</td> </tr> <tr> <td>CE1735A0</td> <td>MINIFIT<br/>FEMALE END<br/>FITTING</td> <td>2.000</td> <td>PC</td> </tr> <tr> <td>CE1740A0</td> <td>MINIFIT MALE<br/>END FITTING</td> <td>2.000</td> <td>PC</td> </tr> <tr> <td>CE1745A0</td> <td>2 WAYS<br/>FEMALE<br/>MINIFIT<br/>CONNECTOR</td> <td>1.000</td> <td>PC</td> </tr> <tr> <td>CE1750A0</td> <td>3 WAYS MALE<br/>MINIFIT<br/>CONNECTOR</td> <td>1.000</td> <td>PC</td> </tr> <tr> <td>LP1002B0</td> <td>LED LIGHTING<br/>BAR L400</td> <td>1.000</td> <td>PC</td> </tr> <tr> <td>VM1620A0</td> <td>LED BAR<br/>LOWER<br/>SUPPORT</td> <td>1.000</td> <td>PC</td> </tr> <tr> <td>VM1621A0</td> <td>LED BAR<br/>UPPER<br/>SUPPORT</td> <td>1.000</td> <td>PC</td> </tr> </tbody> </table> | Code       | Description      | Qty   | UOM  | CE1455A0    | TIP END<br>FITTING | 2.000 | PC       | CE1730A0                                | PVC CABLE NP<br>2 X AWG22<br>STYLE 2095 | 1.000 | M        | CE1735A0                         | MINIFIT<br>FEMALE END<br>FITTING | 2.000 | PC       | CE1740A0                    | MINIFIT MALE<br>END FITTING | 2.000 | PC       | CE1745A0                                 | 2 WAYS<br>FEMALE<br>MINIFIT<br>CONNECTOR | 1.000 | PC       | CE1750A0                            | 3 WAYS MALE<br>MINIFIT<br>CONNECTOR | 1.000 | PC       | LP1002B0              | LED LIGHTING<br>BAR L400 | 1.000 | PC       | VM1620A0                    | LED BAR<br>LOWER<br>SUPPORT | 1.000 | PC       | VM1621A0                    | LED BAR<br>UPPER<br>SUPPORT | 1.000 | PC       |                             |       |    |          |            |       |    |
| Code      | Description                              | Qty   | UOM        |                  |   |      |             |                    |       |          |   |   |       |          |                                  |                                  |       |          |                             |                             |       |          |  |  |       |          |                                     |                                     |       |          |                       |                          |       |          |                             |                             |       |          |                             |                             |       |          |                             |       |    |          |            |       |    |
| CE1455A0  | TIP END<br>FITTING                       | 2.000   | PC         |                  |   |      |             |                    |       |          |   |   |       |          |                                  |                                  |       |          |                             |                             |       |          |  |  |       |          |                                     |                                     |       |          |                       |                          |       |          |                             |                             |       |          |                             |                             |       |          |                             |       |    |          |            |       |    |
| CE1730A0  | PVC CABLE NP<br>2 X AWG22<br>STYLE 2095  | 1.000   | M          |                  |   |      |             |                    |       |          |   |   |       |          |                                  |                                  |       |          |                             |                             |       |          |  |  |       |          |                                     |                                     |       |          |                       |                          |       |          |                             |                             |       |          |                             |                             |       |          |                             |       |    |          |            |       |    |
| CE1735A0  | MINIFIT<br>FEMALE END<br>FITTING         | 2.000   | PC         |                  |   |      |             |                    |       |          |   |   |       |          |                                  |                                  |       |          |                             |                             |       |          |  |  |       |          |                                     |                                     |       |          |                       |                          |       |          |                             |                             |       |          |                             |                             |       |          |                             |       |    |          |            |       |    |
| CE1740A0  | MINIFIT MALE<br>END FITTING              | 2.000   | PC         |                  |   |      |             |                    |       |          |   |   |       |          |                                  |                                  |       |          |                             |                             |       |          |  |  |       |          |                                     |                                     |       |          |                       |                          |       |          |                             |                             |       |          |                             |                             |       |          |                             |       |    |          |            |       |    |
| CE1745A0  | 2 WAYS<br>FEMALE<br>MINIFIT<br>CONNECTOR | 1.000   | PC         |                  |   |      |             |                    |       |          |   |   |       |          |                                  |                                  |       |          |                             |                             |       |          |  |  |       |          |                                     |                                     |       |          |                       |                          |       |          |                             |                             |       |          |                             |                             |       |          |                             |       |    |          |            |       |    |
| CE1750A0  | 3 WAYS MALE<br>MINIFIT<br>CONNECTOR      | 1.000   | PC         |                  |   |      |             |                    |       |          |   |   |       |          |                                  |                                  |       |          |                             |                             |       |          |  |  |       |          |                                     |                                     |       |          |                       |                          |       |          |                             |                             |       |          |                             |                             |       |          |                             |       |    |          |            |       |    |
| LP1002B0  | LED LIGHTING<br>BAR L400                 | 1.000   | PC         |                  |   |      |             |                    |       |          |   |   |       |          |                                  |                                  |       |          |                             |                             |       |          |  |  |       |          |                                     |                                     |       |          |                       |                          |       |          |                             |                             |       |          |                             |                             |       |          |                             |       |    |          |            |       |    |
| VM1620A0  | LED BAR<br>LOWER<br>SUPPORT              | 1.000   | PC         |                  |   |      |             |                    |       |          |   |   |       |          |                                  |                                  |       |          |                             |                             |       |          |  |  |       |          |                                     |                                     |       |          |                       |                          |       |          |                             |                             |       |          |                             |                             |       |          |                             |       |    |          |            |       |    |
| VM1621A0  | LED BAR<br>UPPER<br>SUPPORT              | 1.000   | PC         |                  |   |      |             |                    |       |          |   |   |       |          |                                  |                                  |       |          |                             |                             |       |          |  |  |       |          |                                     |                                     |       |          |                       |                          |       |          |                             |                             |       |          |                             |                             |       |          |                             |       |    |          |            |       |    |

| COMPONENT |                                       |  | SPARE PART |                            |   |      |             |                       |       |          |                   |                       |       |          |                                      |                       |       |          |                                       |       |    |          |                          |       |    |          |                                 |       |    |          |                               |       |    |          |                       |       |    |          |                       |       |    |          |                       |       |    |
|-----------|---------------------------------------|--|------------|----------------------------|---|------|-------------|-----------------------|-------|----------|-------------------|-----------------------|-------|----------|--------------------------------------|-----------------------|-------|----------|---------------------------------------|-------|----|----------|--------------------------|-------|----|----------|---------------------------------|-------|----|----------|-------------------------------|-------|----|----------|-----------------------|-------|----|----------|-----------------------|-------|----|----------|-----------------------|-------|----|
| Code      | Description                           | Image  | Code       | Description                | Kit components  |      |             |                       |       |          |                   |                       |       |          |                                      |                       |       |          |                                       |       |    |          |                          |       |    |          |                                 |       |    |          |                               |       |    |          |                       |       |    |          |                       |       |    |          |                       |       |    |
| VM1621A   | LED BAR UPPER SUPPORT                 |   | KLP1001B   | L300 LED BAR KIT           | <table border="1"> <thead> <tr> <th>Code</th> <th>Description</th> <th>Qty</th> <th>UOM</th> </tr> </thead> <tbody> <tr> <td>CE1455A0</td> <td>TIP END FITTING</td> <td>2.000</td> <td>PC</td> </tr> <tr> <td>CE1730A0</td> <td>PVC CABLE NP 2 X AWG22 STYLE 2095</td> <td>1.000</td> <td>M</td> </tr> <tr> <td>CE1735A0</td> <td>MINIFIT FEMALE END FITTING</td> <td>2.000</td> <td>PC</td> </tr> <tr> <td>CE1740A0</td> <td>MINIFIT MALE END FITTING</td> <td>2.000</td> <td>PC</td> </tr> <tr> <td>CE1745A0</td> <td>2 WAYS FEMALE MINIFIT CONNECTOR</td> <td>1.000</td> <td>PC</td> </tr> <tr> <td>CE1750A0</td> <td>3 WAYS MALE MINIFIT CONNECTOR</td> <td>1.000</td> <td>PC</td> </tr> <tr> <td>LP1001B0</td> <td>LED LIGHTING BAR L300</td> <td>1.000</td> <td>PC</td> </tr> <tr> <td>VM1620A0</td> <td>LED BAR LOWER SUPPORT</td> <td>1.000</td> <td>PC</td> </tr> <tr> <td>VM1621A0</td> <td>LED BAR UPPER SUPPORT</td> <td>1.000</td> <td>PC</td> </tr> </tbody> </table> | Code | Description | Qty                   | UOM   | CE1455A0 | TIP END FITTING   | 2.000                 | PC    | CE1730A0 | PVC CABLE NP 2 X AWG22 STYLE 2095    | 1.000                 | M     | CE1735A0 | MINIFIT FEMALE END FITTING            | 2.000 | PC | CE1740A0 | MINIFIT MALE END FITTING | 2.000 | PC | CE1745A0 | 2 WAYS FEMALE MINIFIT CONNECTOR | 1.000 | PC | CE1750A0 | 3 WAYS MALE MINIFIT CONNECTOR | 1.000 | PC | LP1001B0 | LED LIGHTING BAR L300 | 1.000 | PC | VM1620A0 | LED BAR LOWER SUPPORT | 1.000 | PC | VM1621A0 | LED BAR UPPER SUPPORT | 1.000 | PC |
|           |                                       |  | Code       | Description                | Qty   | UOM  |             |                       |       |          |                   |                       |       |          |                                      |                       |       |          |                                       |       |    |          |                          |       |    |          |                                 |       |    |          |                               |       |    |          |                       |       |    |          |                       |       |    |          |                       |       |    |
| CE1455A0  | TIP END FITTING                       | 2.000  | PC         |                            |   |      |             |                       |       |          |                   |                       |       |          |                                      |                       |       |          |                                       |       |    |          |                          |       |    |          |                                 |       |    |          |                               |       |    |          |                       |       |    |          |                       |       |    |          |                       |       |    |
| CE1730A0  | PVC CABLE NP 2 X AWG22 STYLE 2095     | 1.000  | M          |                            |   |      |             |                       |       |          |                   |                       |       |          |                                      |                       |       |          |                                       |       |    |          |                          |       |    |          |                                 |       |    |          |                               |       |    |          |                       |       |    |          |                       |       |    |          |                       |       |    |
| CE1735A0  | MINIFIT FEMALE END FITTING            | 2.000  | PC         |                            |   |      |             |                       |       |          |                   |                       |       |          |                                      |                       |       |          |                                       |       |    |          |                          |       |    |          |                                 |       |    |          |                               |       |    |          |                       |       |    |          |                       |       |    |          |                       |       |    |
| CE1740A0  | MINIFIT MALE END FITTING              | 2.000  | PC         |                            |   |      |             |                       |       |          |                   |                       |       |          |                                      |                       |       |          |                                       |       |    |          |                          |       |    |          |                                 |       |    |          |                               |       |    |          |                       |       |    |          |                       |       |    |          |                       |       |    |
| CE1745A0  | 2 WAYS FEMALE MINIFIT CONNECTOR       | 1.000  | PC         |                            |   |      |             |                       |       |          |                   |                       |       |          |                                      |                       |       |          |                                       |       |    |          |                          |       |    |          |                                 |       |    |          |                               |       |    |          |                       |       |    |          |                       |       |    |          |                       |       |    |
| CE1750A0  | 3 WAYS MALE MINIFIT CONNECTOR         | 1.000  | PC         |                            |   |      |             |                       |       |          |                   |                       |       |          |                                      |                       |       |          |                                       |       |    |          |                          |       |    |          |                                 |       |    |          |                               |       |    |          |                       |       |    |          |                       |       |    |          |                       |       |    |
| LP1001B0  | LED LIGHTING BAR L300                 | 1.000  | PC         |                            |   |      |             |                       |       |          |                   |                       |       |          |                                      |                       |       |          |                                       |       |    |          |                          |       |    |          |                                 |       |    |          |                               |       |    |          |                       |       |    |          |                       |       |    |          |                       |       |    |
| VM1620A0  | LED BAR LOWER SUPPORT                 | 1.000  | PC         |                            |   |      |             |                       |       |          |                   |                       |       |          |                                      |                       |       |          |                                       |       |    |          |                          |       |    |          |                                 |       |    |          |                               |       |    |          |                       |       |    |          |                       |       |    |          |                       |       |    |
| VM1621A0  | LED BAR UPPER SUPPORT                 | 1.000  | PC         |                            |   |      |             |                       |       |          |                   |                       |       |          |                                      |                       |       |          |                                       |       |    |          |                          |       |    |          |                                 |       |    |          |                               |       |    |          |                       |       |    |          |                       |       |    |          |                       |       |    |
| KLP1000A  | L100 LED BAR KIT                      | <table border="1"> <thead> <tr> <th>Code</th> <th>Description</th> <th>Qty</th> <th>UOM</th> </tr> </thead> <tbody> <tr> <td>LP1000A0</td> <td>LED LIGHTING BAR L100</td> <td>1.000</td> <td>PC</td> </tr> <tr> <td>VM1620A0</td> <td>LED BAR LOWER SUPPORT</td> <td>1.000</td> <td>PC</td> </tr> <tr> <td>VM1621A0</td> <td>LED BAR UPPER SUPPORT</td> <td>1.000</td> <td>PC</td> </tr> </tbody> </table> | Code       | Description                | Qty   | UOM  | LP1000A0    | LED LIGHTING BAR L100 | 1.000 | PC       | VM1620A0          | LED BAR LOWER SUPPORT | 1.000 | PC       | VM1621A0                             | LED BAR UPPER SUPPORT | 1.000 | PC       |                                       |       |    |          |                          |       |    |          |                                 |       |    |          |                               |       |    |          |                       |       |    |          |                       |       |    |          |                       |       |    |
| Code      | Description                           | Qty  | UOM        |                            |   |      |             |                       |       |          |                   |                       |       |          |                                      |                       |       |          |                                       |       |    |          |                          |       |    |          |                                 |       |    |          |                               |       |    |          |                       |       |    |          |                       |       |    |          |                       |       |    |
| LP1000A0  | LED LIGHTING BAR L100                 | 1.000  | PC         |                            |   |      |             |                       |       |          |                   |                       |       |          |                                      |                       |       |          |                                       |       |    |          |                          |       |    |          |                                 |       |    |          |                               |       |    |          |                       |       |    |          |                       |       |    |          |                       |       |    |
| VM1620A0  | LED BAR LOWER SUPPORT                 | 1.000  | PC         |                            |   |      |             |                       |       |          |                   |                       |       |          |                                      |                       |       |          |                                       |       |    |          |                          |       |    |          |                                 |       |    |          |                               |       |    |          |                       |       |    |          |                       |       |    |          |                       |       |    |
| VM1621A0  | LED BAR UPPER SUPPORT                 | 1.000  | PC         |                            |   |      |             |                       |       |          |                   |                       |       |          |                                      |                       |       |          |                                       |       |    |          |                          |       |    |          |                                 |       |    |          |                               |       |    |          |                       |       |    |          |                       |       |    |          |                       |       |    |
| MG1030B   | CT-BT DOOR HANDL                      |   | KMG1030B   | CT-BT-CLUX-BLUX HANDLE KIT | <table border="1"> <thead> <tr> <th>Code</th> <th>Description</th> <th>Qty</th> <th>UOM</th> </tr> </thead> <tbody> <tr> <td>MG1030B2</td> <td>CT-BT DOOR HANDLE</td> <td>1.000</td> <td>PC</td> </tr> <tr> <td>VI0239A1</td> <td>SELF-TAPPIN G SCREW 4.2X25 TCB+ INOX</td> <td>4.000</td> <td>PC</td> </tr> <tr> <td>VM1490A0</td> <td>CHEFTOP/BAK ERTOP HANDLE SCREWS COVER</td> <td>2.000</td> <td>PC</td> </tr> </tbody> </table>   | Code | Description | Qty                   | UOM   | MG1030B2 | CT-BT DOOR HANDLE | 1.000                 | PC    | VI0239A1 | SELF-TAPPIN G SCREW 4.2X25 TCB+ INOX | 4.000                 | PC    | VM1490A0 | CHEFTOP/BAK ERTOP HANDLE SCREWS COVER | 2.000 | PC |          |                          |       |    |          |                                 |       |    |          |                               |       |    |          |                       |       |    |          |                       |       |    |          |                       |       |    |
| Code      | Description                           | Qty  | UOM        |                            |   |      |             |                       |       |          |                   |                       |       |          |                                      |                       |       |          |                                       |       |    |          |                          |       |    |          |                                 |       |    |          |                               |       |    |          |                       |       |    |          |                       |       |    |          |                       |       |    |
| MG1030B2  | CT-BT DOOR HANDLE                     | 1.000  | PC         |                            |   |      |             |                       |       |          |                   |                       |       |          |                                      |                       |       |          |                                       |       |    |          |                          |       |    |          |                                 |       |    |          |                               |       |    |          |                       |       |    |          |                       |       |    |          |                       |       |    |
| VI0239A1  | SELF-TAPPIN G SCREW 4.2X25 TCB+ INOX  | 4.000  | PC         |                            |   |      |             |                       |       |          |                   |                       |       |          |                                      |                       |       |          |                                       |       |    |          |                          |       |    |          |                                 |       |    |          |                               |       |    |          |                       |       |    |          |                       |       |    |          |                       |       |    |
| VM1490A0  | CHEFTOP/BAK ERTOP HANDLE SCREWS COVER | 2.000  | PC         |                            |   |      |             |                       |       |          |                   |                       |       |          |                                      |                       |       |          |                                       |       |    |          |                          |       |    |          |                                 |       |    |          |                               |       |    |          |                       |       |    |          |                       |       |    |          |                       |       |    |



| COMPONENT |   |   | SPARE PART |  |   |      |             |     |     |          |   |       |    |
|-----------|---|---|------------|--|---|------|-------------|-----|-----|----------|---|-------|----|
| Code      | Description                               | Image   | Code       | Description                              | Kit components  |      |             |     |     |          |   |       |    |
| TB2384B   | BAKERLUX<br>CHEFLUX DOOR<br>UPPER LISTEL  |    | TB2384B0   | BAKERLUX<br>CHEFLUX DOOR<br>UPPER LISTEL |   |      |             |     |     |          |   |       |    |
| TB2404A   | BAKERLUX<br>CHEFLUX DOOR<br>LOWER LISTEL  |    | TB2404A0   | BAKERLUX<br>CHEFLUX DOOR<br>LOWER LISTEL |   |      |             |     |     |          |   |       |    |
| TB3092A   | 6TRAY BAKERTOP<br>LEFT DOOR COLUM         |  | TB3092A0   | 6TRAY BAKERTOP<br>LEFT DOOR COLUM        |   |      |             |     |     |          |   |       |    |
| TB3096A   | 6TRAY BAKERTOP<br>RIGHT DOOR<br>COLUMN    |  | TB3096A0   | 6TRAY BAKERTOP<br>RIGHT DOOR<br>COLUMN   |   |      |             |     |     |          |   |       |    |
| VM1510A   | XBC/XVC GROOVED<br>DOOR PIN BUSHING       |  | KVM1510A   | GROOVED DOOR<br>PIN BUSHING 5 PCS<br>KIT | <table border="1"> <thead> <tr> <th>Code</th> <th>Description</th> <th>Qty</th> <th>UOM</th> </tr> </thead> <tbody> <tr> <td>VM1510A0</td> <td>XBC/XVC<br/>GROOVED<br/>DOOR PIN<br/>BUSHING</td> <td>5.000</td> <td>PC</td> </tr> </tbody> </table> | Code | Description | Qty | UOM | VM1510A0 | XBC/XVC<br>GROOVED<br>DOOR PIN<br>BUSHING | 5.000 | PC |
| Code      | Description                               | Qty   | UOM        |  |   |      |             |     |     |          |   |       |    |
| VM1510A0  | XBC/XVC<br>GROOVED<br>DOOR PIN<br>BUSHING | 5.000   | PC         |  |   |      |             |     |     |          |   |       |    |



| COMPONENT |   |   | SPARE PART |  |   |      |             |     |     |          |   |       |    |          |                            |       |    |          |                            |       |    |          |                           |       |    |
|-----------|---|---|------------|--|---|------|-------------|-----|-----|----------|---|-------|----|----------|----------------------------|-------|----|----------|----------------------------|-------|----|----------|---------------------------|-------|----|
| Code      | Description                             | Image   | Code       | Description                            | Kit components  |      |             |     |     |          |   |       |    |          |                            |       |    |          |                            |       |    |          |                           |       |    |
| VM1511A   | XBC/XVC SLEEK DOOR PIN BUSHING          |    | KVM1511A   | 5 PCS SLEEK DOOR PIN BUSHING KIT       | <table border="1"> <thead> <tr> <th>Code</th> <th>Description</th> <th>Qty</th> <th>UOM</th> </tr> </thead> <tbody> <tr> <td>VM1511A0</td> <td>XBC/XVC SLEEK DOOR PIN BUSHING</td> <td>5.000</td> <td>PC</td> </tr> </tbody> </table>   | Code | Description | Qty | UOM | VM1511A0 | XBC/XVC SLEEK DOOR PIN BUSHING          | 5.000 | PC |          |                            |       |    |          |                            |       |    |          |                           |       |    |
| Code      | Description                             | Qty   | UOM        |  |   |      |             |     |     |          |   |       |    |          |                            |       |    |          |                            |       |    |          |                           |       |    |
| VM1511A0  | XBC/XVC SLEEK DOOR PIN BUSHING          | 5.000   | PC         |  |   |      |             |     |     |          |   |       |    |          |                            |       |    |          |                            |       |    |          |                           |       |    |
| VM1680A   | INTERNAL GLASS HINGE                    |    | KVM1680A   | INTERNAL GLASS HINGE SUPPORT 2 PCS KIT | <table border="1"> <thead> <tr> <th>Code</th> <th>Description</th> <th>Qty</th> <th>UOM</th> </tr> </thead> <tbody> <tr> <td>VH1300A0</td> <td>SCREW M6X12 T1/2T+INOX</td> <td>4.000</td> <td>PC</td> </tr> <tr> <td>VM1680A0</td> <td>INTERNAL GLASS HINGE</td> <td>2.000</td> <td>PC</td> </tr> </tbody> </table>   | Code | Description | Qty | UOM | VH1300A0 | SCREW M6X12 T1/2T+INOX                  | 4.000 | PC | VM1680A0 | INTERNAL GLASS HINGE       | 2.000 | PC |          |                            |       |    |          |                           |       |    |
| Code      | Description                             | Qty   | UOM        |  |   |      |             |     |     |          |   |       |    |          |                            |       |    |          |                            |       |    |          |                           |       |    |
| VH1300A0  | SCREW M6X12 T1/2T+INOX                  | 4.000   | PC         |  |   |      |             |     |     |          |   |       |    |          |                            |       |    |          |                            |       |    |          |                           |       |    |
| VM1680A0  | INTERNAL GLASS HINGE                    | 2.000   | PC         |  |   |      |             |     |     |          |   |       |    |          |                            |       |    |          |                            |       |    |          |                           |       |    |
| VM1976A   | CL BL DOOR COLUMN BLANKING CAP          |  | KVM1976A   | CL BL DOOR COLUMN BLANKING CAP KIT     | <table border="1"> <thead> <tr> <th>Code</th> <th>Description</th> <th>Qty</th> <th>UOM</th> </tr> </thead> <tbody> <tr> <td>VM1976A0</td> <td>CL BL DOOR COLUMN BLANKING CA</td> <td>1.000</td> <td>PC</td> </tr> </tbody> </table>  | Code | Description | Qty | UOM | VM1976A0 | CL BL DOOR COLUMN BLANKING CA           | 1.000 | PC |          |                            |       |    |          |                            |       |    |          |                           |       |    |
| Code      | Description                             | Qty   | UOM        |  |   |      |             |     |     |          |   |       |    |          |                            |       |    |          |                            |       |    |          |                           |       |    |
| VM1976A0  | CL BL DOOR COLUMN BLANKING CA           | 1.000   | PC         |  |   |      |             |     |     |          |   |       |    |          |                            |       |    |          |                            |       |    |          |                           |       |    |
| VM1977A   | VM1977A1                                |  | KVM1977A   | CL BL DOOR UPPER FULCRUM-CAP KIT       | <table border="1"> <thead> <tr> <th>Code</th> <th>Description</th> <th>Qty</th> <th>UOM</th> </tr> </thead> <tbody> <tr> <td>VM1977A0</td> <td>CL BL DOOR UPPER FULCRUM-CA</td> <td>1.000</td> <td>PC</td> </tr> </tbody> </table>  | Code | Description | Qty | UOM | VM1977A0 | CL BL DOOR UPPER FULCRUM-CA             | 1.000 | PC |          |                            |       |    |          |                            |       |    |          |                           |       |    |
| Code      | Description                             | Qty   | UOM        |  |   |      |             |     |     |          |   |       |    |          |                            |       |    |          |                            |       |    |          |                           |       |    |
| VM1977A0  | CL BL DOOR UPPER FULCRUM-CA             | 1.000   | PC         |  |   |      |             |     |     |          |   |       |    |          |                            |       |    |          |                            |       |    |          |                           |       |    |
| VM1978A   | VM1978A1                                |  | KDR1254A   | XB893 XV893 COMPLETE DOOR              | <table border="1"> <thead> <tr> <th>Code</th> <th>Description</th> <th>Qty</th> <th>UOM</th> </tr> </thead> <tbody> <tr> <td>0H6575A1</td> <td>XB89- XV EXTERNAL GLASS HOLDING PROFILE</td> <td>2.000</td> <td>PC</td> </tr> <tr> <td>CR1085A0</td> <td>INTERNAL GLASS UPPER HINGE</td> <td>1.000</td> <td>PC</td> </tr> <tr> <td>CR1086A0</td> <td>INTERNAL GLASS LOWER HINGE</td> <td>1.000</td> <td>PC</td> </tr> <tr> <td>GN1181A0</td> <td>INTERNAL GLASS HINGE SEAL</td> <td>2.000</td> <td>PC</td> </tr> </tbody> </table> | Code | Description | Qty | UOM | 0H6575A1 | XB89- XV EXTERNAL GLASS HOLDING PROFILE | 2.000 | PC | CR1085A0 | INTERNAL GLASS UPPER HINGE | 1.000 | PC | CR1086A0 | INTERNAL GLASS LOWER HINGE | 1.000 | PC | GN1181A0 | INTERNAL GLASS HINGE SEAL | 2.000 | PC |
| Code      | Description                             | Qty   | UOM        |  |   |      |             |     |     |          |   |       |    |          |                            |       |    |          |                            |       |    |          |                           |       |    |
| 0H6575A1  | XB89- XV EXTERNAL GLASS HOLDING PROFILE | 2.000   | PC         |  |   |      |             |     |     |          |   |       |    |          |                            |       |    |          |                            |       |    |          |                           |       |    |
| CR1085A0  | INTERNAL GLASS UPPER HINGE              | 1.000   | PC         |  |   |      |             |     |     |          |   |       |    |          |                            |       |    |          |                            |       |    |          |                           |       |    |
| CR1086A0  | INTERNAL GLASS LOWER HINGE              | 1.000   | PC         |  |   |      |             |     |     |          |   |       |    |          |                            |       |    |          |                            |       |    |          |                           |       |    |
| GN1181A0  | INTERNAL GLASS HINGE SEAL               | 2.000   | PC         |  |   |      |             |     |     |          |   |       |    |          |                            |       |    |          |                            |       |    |          |                           |       |    |





| COMPONENT |                                       |   | SPARE PART |                              |  |      |             |     |     |          |                   |       |    |          |                               |       |    |          |                                    |       |    |          |                                       |       |    |          |                                      |       |    |          |                                    |       |    |          |                                      |       |    |          |                              |       |    |          |                         |       |    |          |                                |        |    |          |                        |        |    |          |                             |       |    |          |                              |       |    |          |                                     |       |    |          |                                       |       |    |          |                                  |       |    |
|-----------|---------------------------------------|---|------------|------------------------------|--|------|-------------|-----|-----|----------|-------------------|-------|----|----------|-------------------------------|-------|----|----------|------------------------------------|-------|----|----------|---------------------------------------|-------|----|----------|--------------------------------------|-------|----|----------|------------------------------------|-------|----|----------|--------------------------------------|-------|----|----------|------------------------------|-------|----|----------|-------------------------|-------|----|----------|--------------------------------|--------|----|----------|------------------------|--------|----|----------|-----------------------------|-------|----|----------|------------------------------|-------|----|----------|-------------------------------------|-------|----|----------|---------------------------------------|-------|----|----------|----------------------------------|-------|----|
| Code      | Description                           | Image   | Code       | Description                  | Kit components   |      |             |     |     |          |                   |       |    |          |                               |       |    |          |                                    |       |    |          |                                       |       |    |          |                                      |       |    |          |                                    |       |    |          |                                      |       |    |          |                              |       |    |          |                         |       |    |          |                                |        |    |          |                        |        |    |          |                             |       |    |          |                              |       |    |          |                                     |       |    |          |                                       |       |    |          |                                  |       |    |
| VM1978A   | VM1978A1                              |  | KDR1254A   | XB893 XV893<br>COMPLETE DOOR | <table border="1"> <thead> <tr> <th>Code</th> <th>Description</th> <th>Qty</th> <th>UOM</th> </tr> </thead> <tbody> <tr> <td>MG1030B2</td> <td>CT-BT DOOR HANDLE</td> <td>1.000</td> <td>PC</td> </tr> <tr> <td>SL1110A0</td> <td>BIADHESIVE PIN 3M VHB 9473-PC</td> <td>1.000</td> <td>PC</td> </tr> <tr> <td>TB2384B0</td> <td>BAKERLUX CHEFLUX DOOR UPPER LISTEL</td> <td>1.000</td> <td>PC</td> </tr> <tr> <td>TB2385A0</td> <td>BL CL 89- RIGHT DOOR COLUMN 50x50x1.2</td> <td>1.000</td> <td>PC</td> </tr> <tr> <td>TB2386A0</td> <td>BL CL 89- LEFT DOOR COLUMN 50x50x1.2</td> <td>1.000</td> <td>PC</td> </tr> <tr> <td>TB2404A0</td> <td>BAKERLUX CHEFLUX DOOR LOWER LISTEL</td> <td>1.000</td> <td>PC</td> </tr> <tr> <td>VI0239A1</td> <td>SELF-TAPPIN G SCREW 4.2X25 TCB+ INOX</td> <td>4.000</td> <td>PC</td> </tr> <tr> <td>VI1070A0</td> <td>SCREW M4x16 TSP/UNI7688 INOX</td> <td>1.000</td> <td>PC</td> </tr> <tr> <td>VI1075A0</td> <td>NUT M4 H=4 UNI5587 INOX</td> <td>1.000</td> <td>PC</td> </tr> <tr> <td>VI1220A1</td> <td>4,2x12 TCB SELF-TAPPIN G SCREW</td> <td>28.000</td> <td>PC</td> </tr> <tr> <td>VI1300A0</td> <td>SCREW M6X12 T1/2T+INOX</td> <td>12.000</td> <td>PC</td> </tr> <tr> <td>VI1310A0</td> <td>ZINC THREAD INSERT M6 FTR/E</td> <td>8.000</td> <td>PC</td> </tr> <tr> <td>VI1340A0</td> <td>M6 ST. STEEL THREADED INSERT</td> <td>4.000</td> <td>PC</td> </tr> <tr> <td>VI1810A0</td> <td>M6X6 STAINLESS STEEL FLATHEAD SCREW</td> <td>6.000</td> <td>PC</td> </tr> <tr> <td>VM1490A0</td> <td>CHEFTOP/BAK ERTOP HANDLE SCREWS COVER</td> <td>2.000</td> <td>PC</td> </tr> <tr> <td>VM1510A0</td> <td>XBC/XVC GROOVED DOOR PIN BUSHING</td> <td>1.000</td> <td>PC</td> </tr> </tbody> </table> | Code | Description | Qty | UOM | MG1030B2 | CT-BT DOOR HANDLE | 1.000 | PC | SL1110A0 | BIADHESIVE PIN 3M VHB 9473-PC | 1.000 | PC | TB2384B0 | BAKERLUX CHEFLUX DOOR UPPER LISTEL | 1.000 | PC | TB2385A0 | BL CL 89- RIGHT DOOR COLUMN 50x50x1.2 | 1.000 | PC | TB2386A0 | BL CL 89- LEFT DOOR COLUMN 50x50x1.2 | 1.000 | PC | TB2404A0 | BAKERLUX CHEFLUX DOOR LOWER LISTEL | 1.000 | PC | VI0239A1 | SELF-TAPPIN G SCREW 4.2X25 TCB+ INOX | 4.000 | PC | VI1070A0 | SCREW M4x16 TSP/UNI7688 INOX | 1.000 | PC | VI1075A0 | NUT M4 H=4 UNI5587 INOX | 1.000 | PC | VI1220A1 | 4,2x12 TCB SELF-TAPPIN G SCREW | 28.000 | PC | VI1300A0 | SCREW M6X12 T1/2T+INOX | 12.000 | PC | VI1310A0 | ZINC THREAD INSERT M6 FTR/E | 8.000 | PC | VI1340A0 | M6 ST. STEEL THREADED INSERT | 4.000 | PC | VI1810A0 | M6X6 STAINLESS STEEL FLATHEAD SCREW | 6.000 | PC | VM1490A0 | CHEFTOP/BAK ERTOP HANDLE SCREWS COVER | 2.000 | PC | VM1510A0 | XBC/XVC GROOVED DOOR PIN BUSHING | 1.000 | PC |
| Code      | Description                           | Qty   | UOM        |                              |  |      |             |     |     |          |                   |       |    |          |                               |       |    |          |                                    |       |    |          |                                       |       |    |          |                                      |       |    |          |                                    |       |    |          |                                      |       |    |          |                              |       |    |          |                         |       |    |          |                                |        |    |          |                        |        |    |          |                             |       |    |          |                              |       |    |          |                                     |       |    |          |                                       |       |    |          |                                  |       |    |
| MG1030B2  | CT-BT DOOR HANDLE                     | 1.000   | PC         |                              |  |      |             |     |     |          |                   |       |    |          |                               |       |    |          |                                    |       |    |          |                                       |       |    |          |                                      |       |    |          |                                    |       |    |          |                                      |       |    |          |                              |       |    |          |                         |       |    |          |                                |        |    |          |                        |        |    |          |                             |       |    |          |                              |       |    |          |                                     |       |    |          |                                       |       |    |          |                                  |       |    |
| SL1110A0  | BIADHESIVE PIN 3M VHB 9473-PC         | 1.000   | PC         |                              |  |      |             |     |     |          |                   |       |    |          |                               |       |    |          |                                    |       |    |          |                                       |       |    |          |                                      |       |    |          |                                    |       |    |          |                                      |       |    |          |                              |       |    |          |                         |       |    |          |                                |        |    |          |                        |        |    |          |                             |       |    |          |                              |       |    |          |                                     |       |    |          |                                       |       |    |          |                                  |       |    |
| TB2384B0  | BAKERLUX CHEFLUX DOOR UPPER LISTEL    | 1.000   | PC         |                              |  |      |             |     |     |          |                   |       |    |          |                               |       |    |          |                                    |       |    |          |                                       |       |    |          |                                      |       |    |          |                                    |       |    |          |                                      |       |    |          |                              |       |    |          |                         |       |    |          |                                |        |    |          |                        |        |    |          |                             |       |    |          |                              |       |    |          |                                     |       |    |          |                                       |       |    |          |                                  |       |    |
| TB2385A0  | BL CL 89- RIGHT DOOR COLUMN 50x50x1.2 | 1.000   | PC         |                              |  |      |             |     |     |          |                   |       |    |          |                               |       |    |          |                                    |       |    |          |                                       |       |    |          |                                      |       |    |          |                                    |       |    |          |                                      |       |    |          |                              |       |    |          |                         |       |    |          |                                |        |    |          |                        |        |    |          |                             |       |    |          |                              |       |    |          |                                     |       |    |          |                                       |       |    |          |                                  |       |    |
| TB2386A0  | BL CL 89- LEFT DOOR COLUMN 50x50x1.2  | 1.000   | PC         |                              |  |      |             |     |     |          |                   |       |    |          |                               |       |    |          |                                    |       |    |          |                                       |       |    |          |                                      |       |    |          |                                    |       |    |          |                                      |       |    |          |                              |       |    |          |                         |       |    |          |                                |        |    |          |                        |        |    |          |                             |       |    |          |                              |       |    |          |                                     |       |    |          |                                       |       |    |          |                                  |       |    |
| TB2404A0  | BAKERLUX CHEFLUX DOOR LOWER LISTEL    | 1.000   | PC         |                              |  |      |             |     |     |          |                   |       |    |          |                               |       |    |          |                                    |       |    |          |                                       |       |    |          |                                      |       |    |          |                                    |       |    |          |                                      |       |    |          |                              |       |    |          |                         |       |    |          |                                |        |    |          |                        |        |    |          |                             |       |    |          |                              |       |    |          |                                     |       |    |          |                                       |       |    |          |                                  |       |    |
| VI0239A1  | SELF-TAPPIN G SCREW 4.2X25 TCB+ INOX  | 4.000   | PC         |                              |  |      |             |     |     |          |                   |       |    |          |                               |       |    |          |                                    |       |    |          |                                       |       |    |          |                                      |       |    |          |                                    |       |    |          |                                      |       |    |          |                              |       |    |          |                         |       |    |          |                                |        |    |          |                        |        |    |          |                             |       |    |          |                              |       |    |          |                                     |       |    |          |                                       |       |    |          |                                  |       |    |
| VI1070A0  | SCREW M4x16 TSP/UNI7688 INOX          | 1.000   | PC         |                              |  |      |             |     |     |          |                   |       |    |          |                               |       |    |          |                                    |       |    |          |                                       |       |    |          |                                      |       |    |          |                                    |       |    |          |                                      |       |    |          |                              |       |    |          |                         |       |    |          |                                |        |    |          |                        |        |    |          |                             |       |    |          |                              |       |    |          |                                     |       |    |          |                                       |       |    |          |                                  |       |    |
| VI1075A0  | NUT M4 H=4 UNI5587 INOX               | 1.000   | PC         |                              |  |      |             |     |     |          |                   |       |    |          |                               |       |    |          |                                    |       |    |          |                                       |       |    |          |                                      |       |    |          |                                    |       |    |          |                                      |       |    |          |                              |       |    |          |                         |       |    |          |                                |        |    |          |                        |        |    |          |                             |       |    |          |                              |       |    |          |                                     |       |    |          |                                       |       |    |          |                                  |       |    |
| VI1220A1  | 4,2x12 TCB SELF-TAPPIN G SCREW        | 28.000  | PC         |                              |  |      |             |     |     |          |                   |       |    |          |                               |       |    |          |                                    |       |    |          |                                       |       |    |          |                                      |       |    |          |                                    |       |    |          |                                      |       |    |          |                              |       |    |          |                         |       |    |          |                                |        |    |          |                        |        |    |          |                             |       |    |          |                              |       |    |          |                                     |       |    |          |                                       |       |    |          |                                  |       |    |
| VI1300A0  | SCREW M6X12 T1/2T+INOX                | 12.000  | PC         |                              |  |      |             |     |     |          |                   |       |    |          |                               |       |    |          |                                    |       |    |          |                                       |       |    |          |                                      |       |    |          |                                    |       |    |          |                                      |       |    |          |                              |       |    |          |                         |       |    |          |                                |        |    |          |                        |        |    |          |                             |       |    |          |                              |       |    |          |                                     |       |    |          |                                       |       |    |          |                                  |       |    |
| VI1310A0  | ZINC THREAD INSERT M6 FTR/E           | 8.000   | PC         |                              |  |      |             |     |     |          |                   |       |    |          |                               |       |    |          |                                    |       |    |          |                                       |       |    |          |                                      |       |    |          |                                    |       |    |          |                                      |       |    |          |                              |       |    |          |                         |       |    |          |                                |        |    |          |                        |        |    |          |                             |       |    |          |                              |       |    |          |                                     |       |    |          |                                       |       |    |          |                                  |       |    |
| VI1340A0  | M6 ST. STEEL THREADED INSERT          | 4.000   | PC         |                              |  |      |             |     |     |          |                   |       |    |          |                               |       |    |          |                                    |       |    |          |                                       |       |    |          |                                      |       |    |          |                                    |       |    |          |                                      |       |    |          |                              |       |    |          |                         |       |    |          |                                |        |    |          |                        |        |    |          |                             |       |    |          |                              |       |    |          |                                     |       |    |          |                                       |       |    |          |                                  |       |    |
| VI1810A0  | M6X6 STAINLESS STEEL FLATHEAD SCREW   | 6.000   | PC         |                              |  |      |             |     |     |          |                   |       |    |          |                               |       |    |          |                                    |       |    |          |                                       |       |    |          |                                      |       |    |          |                                    |       |    |          |                                      |       |    |          |                              |       |    |          |                         |       |    |          |                                |        |    |          |                        |        |    |          |                             |       |    |          |                              |       |    |          |                                     |       |    |          |                                       |       |    |          |                                  |       |    |
| VM1490A0  | CHEFTOP/BAK ERTOP HANDLE SCREWS COVER | 2.000   | PC         |                              |  |      |             |     |     |          |                   |       |    |          |                               |       |    |          |                                    |       |    |          |                                       |       |    |          |                                      |       |    |          |                                    |       |    |          |                                      |       |    |          |                              |       |    |          |                         |       |    |          |                                |        |    |          |                        |        |    |          |                             |       |    |          |                              |       |    |          |                                     |       |    |          |                                       |       |    |          |                                  |       |    |
| VM1510A0  | XBC/XVC GROOVED DOOR PIN BUSHING      | 1.000   | PC         |                              |  |      |             |     |     |          |                   |       |    |          |                               |       |    |          |                                    |       |    |          |                                       |       |    |          |                                      |       |    |          |                                    |       |    |          |                                      |       |    |          |                              |       |    |          |                         |       |    |          |                                |        |    |          |                        |        |    |          |                             |       |    |          |                              |       |    |          |                                     |       |    |          |                                       |       |    |          |                                  |       |    |





| COMPONENT |   |   | SPARE PART |   |   |      |             |     |     |          |  |       |    |          |                                      |       |    |          |   |       |    |          |                         |       |    |          |                                     |       |    |          |                                   |       |    |          |                                   |       |    |          |                                  |       |    |          |                          |       |    |          |   |       |    |          |                                      |       |    |          |  |       |    |          |                            |       |    |
|-----------|---|---|------------|---|---|------|-------------|-----|-----|----------|--|-------|----|----------|--------------------------------------|-------|----|----------|---|-------|----|----------|-------------------------|-------|----|----------|-------------------------------------|-------|----|----------|-----------------------------------|-------|----|----------|-----------------------------------|-------|----|----------|----------------------------------|-------|----|----------|--------------------------|-------|----|----------|---|-------|----|----------|--------------------------------------|-------|----|----------|--|-------|----|----------|----------------------------|-------|----|
| Code      | Description                                       | Image   | Code       | Description                             | Kit components  |      |             |     |     |          |  |       |    |          |                                      |       |    |          |   |       |    |          |                         |       |    |          |                                     |       |    |          |                                   |       |    |          |                                   |       |    |          |                                  |       |    |          |                          |       |    |          |   |       |    |          |                                      |       |    |          |  |       |    |          |                            |       |    |
| VM1978A   | VM1978A1  |    | KDR1254A   | XB893 XV893<br>COMPLETE DOOR            | <table border="1"> <thead> <tr> <th>Code</th> <th>Description</th> <th>Qty</th> <th>UOM</th> </tr> </thead> <tbody> <tr> <td>VM1511A0</td> <td>XBC/XVC<br/>SLEEK DOOR<br/>PIN BUSHING</td> <td>1.000</td> <td>PC</td> </tr> <tr> <td>VM1591A0</td> <td>GLASS<br/>BRACKET INT.<br/>XVC1004</td> <td>1.000</td> <td>PC</td> </tr> <tr> <td>VM1630A1</td> <td>INTERNAL<br/>GLASS<br/>PUSHING CAP</td> <td>2.000</td> <td>PC</td> </tr> <tr> <td>VM1680A0</td> <td>INTERNAL<br/>GLASS HINGE</td> <td>2.000</td> <td>PC</td> </tr> <tr> <td>VM1976A0</td> <td>CL BL DOOR<br/>COLUMN<br/>BLANKING CA</td> <td>2.000</td> <td>PC</td> </tr> <tr> <td>VM1977A0</td> <td>CL BL DOOR<br/>UPPER<br/>FULCRUM-CA</td> <td>1.000</td> <td>PC</td> </tr> <tr> <td>VM1978A0</td> <td>CL BL DOOR<br/>LOWER<br/>FULCRUM-CA</td> <td>1.000</td> <td>PC</td> </tr> <tr> <td>VM2000A0</td> <td>M4 SOCKET<br/>HEAD SCREW<br/>COVER</td> <td>6.000</td> <td>PC</td> </tr> <tr> <td>VM2008A0</td> <td>SPACER FOR<br/>MICROSWITC</td> <td>1.000</td> <td>PC</td> </tr> <tr> <td>VM2042A0</td> <td>INTERNAL<br/>GLASS<br/>LATERAL<br/>LOCKING<br/>SYSTEM</td> <td>2.000</td> <td>PC</td> </tr> <tr> <td>VM2043A0</td> <td>UPPER -<br/>LOWER<br/>GLASS<br/>SUPPORT</td> <td>2.000</td> <td>PC</td> </tr> <tr> <td>VT1140A0</td> <td>XB893/895<br/>XBC804/805<br/>INTERNAL<br/>GLASS</td> <td>1.000</td> <td>PC</td> </tr> <tr> <td>VT1254A0</td> <td>OUTER GLASS<br/>XB89- XC89-</td> <td>1.000</td> <td>PC</td> </tr> </tbody> </table> | Code | Description | Qty | UOM | VM1511A0 | XBC/XVC<br>SLEEK DOOR<br>PIN BUSHING             | 1.000 | PC | VM1591A0 | GLASS<br>BRACKET INT.<br>XVC1004     | 1.000 | PC | VM1630A1 | INTERNAL<br>GLASS<br>PUSHING CAP                  | 2.000 | PC | VM1680A0 | INTERNAL<br>GLASS HINGE | 2.000 | PC | VM1976A0 | CL BL DOOR<br>COLUMN<br>BLANKING CA | 2.000 | PC | VM1977A0 | CL BL DOOR<br>UPPER<br>FULCRUM-CA | 1.000 | PC | VM1978A0 | CL BL DOOR<br>LOWER<br>FULCRUM-CA | 1.000 | PC | VM2000A0 | M4 SOCKET<br>HEAD SCREW<br>COVER | 6.000 | PC | VM2008A0 | SPACER FOR<br>MICROSWITC | 1.000 | PC | VM2042A0 | INTERNAL<br>GLASS<br>LATERAL<br>LOCKING<br>SYSTEM | 2.000 | PC | VM2043A0 | UPPER -<br>LOWER<br>GLASS<br>SUPPORT | 2.000 | PC | VT1140A0 | XB893/895<br>XBC804/805<br>INTERNAL<br>GLASS | 1.000 | PC | VT1254A0 | OUTER GLASS<br>XB89- XC89- | 1.000 | PC |
| Code      | Description                                       | Qty   | UOM        |   |   |      |             |     |     |          |  |       |    |          |                                      |       |    |          |   |       |    |          |                         |       |    |          |                                     |       |    |          |                                   |       |    |          |                                   |       |    |          |                                  |       |    |          |                          |       |    |          |   |       |    |          |                                      |       |    |          |  |       |    |          |                            |       |    |
| VM1511A0  | XBC/XVC<br>SLEEK DOOR<br>PIN BUSHING              | 1.000   | PC         |   |   |      |             |     |     |          |  |       |    |          |                                      |       |    |          |   |       |    |          |                         |       |    |          |                                     |       |    |          |                                   |       |    |          |                                   |       |    |          |                                  |       |    |          |                          |       |    |          |   |       |    |          |                                      |       |    |          |  |       |    |          |                            |       |    |
| VM1591A0  | GLASS<br>BRACKET INT.<br>XVC1004                  | 1.000   | PC         |   |   |      |             |     |     |          |  |       |    |          |                                      |       |    |          |   |       |    |          |                         |       |    |          |                                     |       |    |          |                                   |       |    |          |                                   |       |    |          |                                  |       |    |          |                          |       |    |          |   |       |    |          |                                      |       |    |          |  |       |    |          |                            |       |    |
| VM1630A1  | INTERNAL<br>GLASS<br>PUSHING CAP                  | 2.000   | PC         |   |   |      |             |     |     |          |  |       |    |          |                                      |       |    |          |   |       |    |          |                         |       |    |          |                                     |       |    |          |                                   |       |    |          |                                   |       |    |          |                                  |       |    |          |                          |       |    |          |   |       |    |          |                                      |       |    |          |  |       |    |          |                            |       |    |
| VM1680A0  | INTERNAL<br>GLASS HINGE                           | 2.000   | PC         |   |   |      |             |     |     |          |  |       |    |          |                                      |       |    |          |   |       |    |          |                         |       |    |          |                                     |       |    |          |                                   |       |    |          |                                   |       |    |          |                                  |       |    |          |                          |       |    |          |   |       |    |          |                                      |       |    |          |  |       |    |          |                            |       |    |
| VM1976A0  | CL BL DOOR<br>COLUMN<br>BLANKING CA               | 2.000   | PC         |   |   |      |             |     |     |          |  |       |    |          |                                      |       |    |          |   |       |    |          |                         |       |    |          |                                     |       |    |          |                                   |       |    |          |                                   |       |    |          |                                  |       |    |          |                          |       |    |          |   |       |    |          |                                      |       |    |          |  |       |    |          |                            |       |    |
| VM1977A0  | CL BL DOOR<br>UPPER<br>FULCRUM-CA                 | 1.000   | PC         |   |   |      |             |     |     |          |  |       |    |          |                                      |       |    |          |   |       |    |          |                         |       |    |          |                                     |       |    |          |                                   |       |    |          |                                   |       |    |          |                                  |       |    |          |                          |       |    |          |   |       |    |          |                                      |       |    |          |  |       |    |          |                            |       |    |
| VM1978A0  | CL BL DOOR<br>LOWER<br>FULCRUM-CA                 | 1.000   | PC         |   |   |      |             |     |     |          |  |       |    |          |                                      |       |    |          |   |       |    |          |                         |       |    |          |                                     |       |    |          |                                   |       |    |          |                                   |       |    |          |                                  |       |    |          |                          |       |    |          |   |       |    |          |                                      |       |    |          |  |       |    |          |                            |       |    |
| VM2000A0  | M4 SOCKET<br>HEAD SCREW<br>COVER                  | 6.000   | PC         |   |   |      |             |     |     |          |  |       |    |          |                                      |       |    |          |   |       |    |          |                         |       |    |          |                                     |       |    |          |                                   |       |    |          |                                   |       |    |          |                                  |       |    |          |                          |       |    |          |   |       |    |          |                                      |       |    |          |  |       |    |          |                            |       |    |
| VM2008A0  | SPACER FOR<br>MICROSWITC                          | 1.000   | PC         |   |   |      |             |     |     |          |  |       |    |          |                                      |       |    |          |   |       |    |          |                         |       |    |          |                                     |       |    |          |                                   |       |    |          |                                   |       |    |          |                                  |       |    |          |                          |       |    |          |   |       |    |          |                                      |       |    |          |  |       |    |          |                            |       |    |
| VM2042A0  | INTERNAL<br>GLASS<br>LATERAL<br>LOCKING<br>SYSTEM | 2.000   | PC         |   |   |      |             |     |     |          |  |       |    |          |                                      |       |    |          |   |       |    |          |                         |       |    |          |                                     |       |    |          |                                   |       |    |          |                                   |       |    |          |                                  |       |    |          |                          |       |    |          |   |       |    |          |                                      |       |    |          |  |       |    |          |                            |       |    |
| VM2043A0  | UPPER -<br>LOWER<br>GLASS<br>SUPPORT              | 2.000   | PC         |   |   |      |             |     |     |          |  |       |    |          |                                      |       |    |          |   |       |    |          |                         |       |    |          |                                     |       |    |          |                                   |       |    |          |                                   |       |    |          |                                  |       |    |          |                          |       |    |          |   |       |    |          |                                      |       |    |          |  |       |    |          |                            |       |    |
| VT1140A0  | XB893/895<br>XBC804/805<br>INTERNAL<br>GLASS      | 1.000   | PC         |   |   |      |             |     |     |          |  |       |    |          |                                      |       |    |          |   |       |    |          |                         |       |    |          |                                     |       |    |          |                                   |       |    |          |                                   |       |    |          |                                  |       |    |          |                          |       |    |          |   |       |    |          |                                      |       |    |          |  |       |    |          |                            |       |    |
| VT1254A0  | OUTER GLASS<br>XB89- XC89-                        | 1.000   | PC         |   |   |      |             |     |     |          |  |       |    |          |                                      |       |    |          |   |       |    |          |                         |       |    |          |                                     |       |    |          |                                   |       |    |          |                                   |       |    |          |                                  |       |    |          |                          |       |    |          |   |       |    |          |                                      |       |    |          |  |       |    |          |                            |       |    |
| VM2042A   | INTERNAL GLASS<br>LATERAL LOCKING<br>SYSTEM       |  | KVM2042A   | INTERNAL GLASS<br>SPRING STOPPER<br>KIT | <table border="1"> <thead> <tr> <th>Code</th> <th>Description</th> <th>Qty</th> <th>UOM</th> </tr> </thead> <tbody> <tr> <td>RC1200A0</td> <td>ED=4 WIRE<br/>D=0.5 H24<br/>COMPRESSIO<br/>N SPRING</td> <td>2.000</td> <td>PC</td> </tr> <tr> <td>VI1220A1</td> <td>4,2x12 TCB<br/>SELF-TAPPIN<br/>G SCREW</td> <td>2.000</td> <td>PC</td> </tr> <tr> <td>VM2042A0</td> <td>INTERNAL<br/>GLASS<br/>LATERAL<br/>LOCKING<br/>SYSTEM</td> <td>1.000</td> <td>PC</td> </tr> </tbody> </table>   | Code | Description | Qty | UOM | RC1200A0 | ED=4 WIRE<br>D=0.5 H24<br>COMPRESSIO<br>N SPRING | 2.000 | PC | VI1220A1 | 4,2x12 TCB<br>SELF-TAPPIN<br>G SCREW | 2.000 | PC | VM2042A0 | INTERNAL<br>GLASS<br>LATERAL<br>LOCKING<br>SYSTEM | 1.000 | PC |          |                         |       |    |          |                                     |       |    |          |                                   |       |    |          |                                   |       |    |          |                                  |       |    |          |                          |       |    |          |   |       |    |          |                                      |       |    |          |  |       |    |          |                            |       |    |
| Code      | Description                                       | Qty   | UOM        |   |   |      |             |     |     |          |  |       |    |          |                                      |       |    |          |   |       |    |          |                         |       |    |          |                                     |       |    |          |                                   |       |    |          |                                   |       |    |          |                                  |       |    |          |                          |       |    |          |   |       |    |          |                                      |       |    |          |  |       |    |          |                            |       |    |
| RC1200A0  | ED=4 WIRE<br>D=0.5 H24<br>COMPRESSIO<br>N SPRING  | 2.000   | PC         |   |   |      |             |     |     |          |  |       |    |          |                                      |       |    |          |   |       |    |          |                         |       |    |          |                                     |       |    |          |                                   |       |    |          |                                   |       |    |          |                                  |       |    |          |                          |       |    |          |   |       |    |          |                                      |       |    |          |  |       |    |          |                            |       |    |
| VI1220A1  | 4,2x12 TCB<br>SELF-TAPPIN<br>G SCREW              | 2.000   | PC         |   |   |      |             |     |     |          |  |       |    |          |                                      |       |    |          |   |       |    |          |                         |       |    |          |                                     |       |    |          |                                   |       |    |          |                                   |       |    |          |                                  |       |    |          |                          |       |    |          |   |       |    |          |                                      |       |    |          |  |       |    |          |                            |       |    |
| VM2042A0  | INTERNAL<br>GLASS<br>LATERAL<br>LOCKING<br>SYSTEM | 1.000   | PC         |   |   |      |             |     |     |          |  |       |    |          |                                      |       |    |          |   |       |    |          |                         |       |    |          |                                     |       |    |          |                                   |       |    |          |                                   |       |    |          |                                  |       |    |          |                          |       |    |          |   |       |    |          |                                      |       |    |          |  |       |    |          |                            |       |    |



| COMPONENT |   |  | SPARE PART                                       |  |   |      |             |     |     |          |   |       |    |          |                            |       |    |          |   |       |    |          |                            |       |    |          |   |       |    |          |                            |       |    |          |                            |       |    |          |                           |       |    |          |             |       |    |          |                   |       |    |          |                                    |       |    |
|-----------|---|--|--|--|---|------|-------------|-----|-----|----------|---|-------|----|----------|----------------------------|-------|----|----------|---|-------|----|----------|----------------------------|-------|----|----------|---|-------|----|----------|----------------------------|-------|----|----------|----------------------------|-------|----|----------|---------------------------|-------|----|----------|-------------|-------|----|----------|-------------------|-------|----|----------|------------------------------------|-------|----|
| Code      | Description                             | Image  | Code   | Description  | Kit components  |      |             |     |     |          |   |       |    |          |                            |       |    |          |   |       |    |          |                            |       |    |          |   |       |    |          |                            |       |    |          |                            |       |    |          |                           |       |    |          |             |       |    |          |                   |       |    |          |                                    |       |    |
| VM2043A   | UPPER - LOWER GLASS SUPPORT             |   | KVM2043A   | UPPER - LOWER GLASS SUPPORT 2 PCS KIT  | <table border="1"> <thead> <tr> <th>Code</th> <th>Description</th> <th>Qty</th> <th>UOM</th> </tr> </thead> <tbody> <tr> <td>VM2043A0</td> <td>UPPER - LOWER GLASS SUPPORT</td> <td>2.000</td> <td>PC</td> </tr> </tbody> </table>  | Code | Description | Qty | UOM | VM2043A0 | UPPER - LOWER GLASS SUPPORT             | 2.000 | PC |          |                            |       |    |          |   |       |    |          |                            |       |    |          |   |       |    |          |                            |       |    |          |                            |       |    |          |                           |       |    |          |             |       |    |          |                   |       |    |          |                                    |       |    |
| Code      | Description                             | Qty  | UOM  |  |   |      |             |     |     |          |   |       |    |          |                            |       |    |          |   |       |    |          |                            |       |    |          |   |       |    |          |                            |       |    |          |                            |       |    |          |                           |       |    |          |             |       |    |          |                   |       |    |          |                                    |       |    |
| VM2043A0  | UPPER - LOWER GLASS SUPPORT             | 2.000  | PC   |  |   |      |             |     |     |          |   |       |    |          |                            |       |    |          |   |       |    |          |                            |       |    |          |   |       |    |          |                            |       |    |          |                            |       |    |          |                           |       |    |          |             |       |    |          |                   |       |    |          |                                    |       |    |
| VT1255A   | XB69- XC59- EXTERNAL GLASS              |  | <p>KVT1255AR</p> <p>KVT1255A</p> <p>KDR1279A</p> | <p>XB69-XV593 LED EXTERNAL GLASS KIT</p> <p>XB69- XV593 EXTERNAL GLASS KIT</p> <p>XB693/695/613G LED COMPLETE DOOR KIT</p> | <table border="1"> <thead> <tr> <th>Code</th> <th>Description</th> <th>Qty</th> <th>UOM</th> </tr> </thead> <tbody> <tr> <td>0H7529A0</td> <td>XB69- XV EXTERNAL GLASS HOLDING PROFILE</td> <td>2.000</td> <td>PC</td> </tr> <tr> <td>VT1255A0</td> <td>XB69- XC59- EXTERNAL GLASS</td> <td>1.000</td> <td>PC</td> </tr> <tr> <td>0H6571A1</td> <td>XB69- XV EXTERNAL GLASS HOLDING PROFILE</td> <td>2.000</td> <td>PC</td> </tr> <tr> <td>VT1255A0</td> <td>XB69- XC59- EXTERNAL GLASS</td> <td>1.000</td> <td>PC</td> </tr> <tr> <td>0H7529A0</td> <td>XB69- XV EXTERNAL GLASS HOLDING PROFILE</td> <td>2.000</td> <td>PC</td> </tr> <tr> <td>CR1085A0</td> <td>INTERNAL GLASS UPPER HINGE</td> <td>2.000</td> <td>PC</td> </tr> <tr> <td>CR1086A0</td> <td>INTERNAL GLASS LOWER HINGE</td> <td>2.000</td> <td>PC</td> </tr> <tr> <td>GN1181A0</td> <td>INTERNAL GLASS HINGE SEAL</td> <td>2.000</td> <td>PC</td> </tr> <tr> <td>LP1044A0</td> <td>LUX LED BAR</td> <td>1.000</td> <td>PC</td> </tr> <tr> <td>MG1030B2</td> <td>CT-BT DOOR HANDLE</td> <td>1.000</td> <td>PC</td> </tr> <tr> <td>TB2384B0</td> <td>BAKERLUX CHEFLUX DOOR UPPER LISTEL</td> <td>1.000</td> <td>PC</td> </tr> </tbody> </table> | Code | Description | Qty | UOM | 0H7529A0 | XB69- XV EXTERNAL GLASS HOLDING PROFILE | 2.000 | PC | VT1255A0 | XB69- XC59- EXTERNAL GLASS | 1.000 | PC | 0H6571A1 | XB69- XV EXTERNAL GLASS HOLDING PROFILE | 2.000 | PC | VT1255A0 | XB69- XC59- EXTERNAL GLASS | 1.000 | PC | 0H7529A0 | XB69- XV EXTERNAL GLASS HOLDING PROFILE | 2.000 | PC | CR1085A0 | INTERNAL GLASS UPPER HINGE | 2.000 | PC | CR1086A0 | INTERNAL GLASS LOWER HINGE | 2.000 | PC | GN1181A0 | INTERNAL GLASS HINGE SEAL | 2.000 | PC | LP1044A0 | LUX LED BAR | 1.000 | PC | MG1030B2 | CT-BT DOOR HANDLE | 1.000 | PC | TB2384B0 | BAKERLUX CHEFLUX DOOR UPPER LISTEL | 1.000 | PC |
| Code      | Description                             | Qty  | UOM  |  |   |      |             |     |     |          |   |       |    |          |                            |       |    |          |   |       |    |          |                            |       |    |          |   |       |    |          |                            |       |    |          |                            |       |    |          |                           |       |    |          |             |       |    |          |                   |       |    |          |                                    |       |    |
| 0H7529A0  | XB69- XV EXTERNAL GLASS HOLDING PROFILE | 2.000  | PC   |  |   |      |             |     |     |          |   |       |    |          |                            |       |    |          |   |       |    |          |                            |       |    |          |   |       |    |          |                            |       |    |          |                            |       |    |          |                           |       |    |          |             |       |    |          |                   |       |    |          |                                    |       |    |
| VT1255A0  | XB69- XC59- EXTERNAL GLASS              | 1.000  | PC   |  |   |      |             |     |     |          |   |       |    |          |                            |       |    |          |   |       |    |          |                            |       |    |          |   |       |    |          |                            |       |    |          |                            |       |    |          |                           |       |    |          |             |       |    |          |                   |       |    |          |                                    |       |    |
| 0H6571A1  | XB69- XV EXTERNAL GLASS HOLDING PROFILE | 2.000  | PC   |  |   |      |             |     |     |          |   |       |    |          |                            |       |    |          |   |       |    |          |                            |       |    |          |   |       |    |          |                            |       |    |          |                            |       |    |          |                           |       |    |          |             |       |    |          |                   |       |    |          |                                    |       |    |
| VT1255A0  | XB69- XC59- EXTERNAL GLASS              | 1.000  | PC   |  |   |      |             |     |     |          |   |       |    |          |                            |       |    |          |   |       |    |          |                            |       |    |          |   |       |    |          |                            |       |    |          |                            |       |    |          |                           |       |    |          |             |       |    |          |                   |       |    |          |                                    |       |    |
| 0H7529A0  | XB69- XV EXTERNAL GLASS HOLDING PROFILE | 2.000  | PC   |  |   |      |             |     |     |          |   |       |    |          |                            |       |    |          |   |       |    |          |                            |       |    |          |   |       |    |          |                            |       |    |          |                            |       |    |          |                           |       |    |          |             |       |    |          |                   |       |    |          |                                    |       |    |
| CR1085A0  | INTERNAL GLASS UPPER HINGE              | 2.000  | PC   |  |   |      |             |     |     |          |   |       |    |          |                            |       |    |          |   |       |    |          |                            |       |    |          |   |       |    |          |                            |       |    |          |                            |       |    |          |                           |       |    |          |             |       |    |          |                   |       |    |          |                                    |       |    |
| CR1086A0  | INTERNAL GLASS LOWER HINGE              | 2.000  | PC   |  |   |      |             |     |     |          |   |       |    |          |                            |       |    |          |   |       |    |          |                            |       |    |          |   |       |    |          |                            |       |    |          |                            |       |    |          |                           |       |    |          |             |       |    |          |                   |       |    |          |                                    |       |    |
| GN1181A0  | INTERNAL GLASS HINGE SEAL               | 2.000  | PC   |  |   |      |             |     |     |          |   |       |    |          |                            |       |    |          |   |       |    |          |                            |       |    |          |   |       |    |          |                            |       |    |          |                            |       |    |          |                           |       |    |          |             |       |    |          |                   |       |    |          |                                    |       |    |
| LP1044A0  | LUX LED BAR                             | 1.000  | PC   |  |   |      |             |     |     |          |   |       |    |          |                            |       |    |          |   |       |    |          |                            |       |    |          |   |       |    |          |                            |       |    |          |                            |       |    |          |                           |       |    |          |             |       |    |          |                   |       |    |          |                                    |       |    |
| MG1030B2  | CT-BT DOOR HANDLE                       | 1.000  | PC   |  |   |      |             |     |     |          |   |       |    |          |                            |       |    |          |   |       |    |          |                            |       |    |          |   |       |    |          |                            |       |    |          |                            |       |    |          |                           |       |    |          |             |       |    |          |                   |       |    |          |                                    |       |    |
| TB2384B0  | BAKERLUX CHEFLUX DOOR UPPER LISTEL      | 1.000  | PC   |  |   |      |             |     |     |          |   |       |    |          |                            |       |    |          |   |       |    |          |                            |       |    |          |   |       |    |          |                            |       |    |          |                            |       |    |          |                           |       |    |          |             |       |    |          |                   |       |    |          |                                    |       |    |



| COMPONENT |   |   | SPARE PART |  |   |      |             |     |     |          |   |       |    |          |  |       |    |          |   |       |    |          |  |       |    |          |   |       |    |          |                                    |       |    |          |                            |       |    |          |                                      |        |    |          |                           |        |    |          |                                   |       |    |          |                                    |       |    |          |   |       |    |          |   |       |    |          |   |       |    |          |                                      |       |    |  |
|-----------|---|---|------------|--|---|------|-------------|-----|-----|----------|---|-------|----|----------|--|-------|----|----------|---|-------|----|----------|--|-------|----|----------|---|-------|----|----------|------------------------------------|-------|----|----------|----------------------------|-------|----|----------|--------------------------------------|--------|----|----------|---------------------------|--------|----|----------|-----------------------------------|-------|----|----------|------------------------------------|-------|----|----------|---|-------|----|----------|---|-------|----|----------|---|-------|----|----------|--------------------------------------|-------|----|--|
| Code      | Description                                       | Image   | Code       | Description                                | Kit components  |      |             |     |     |          |   |       |    |          |  |       |    |          |   |       |    |          |  |       |    |          |   |       |    |          |                                    |       |    |          |                            |       |    |          |                                      |        |    |          |                           |        |    |          |                                   |       |    |          |                                    |       |    |          |   |       |    |          |   |       |    |          |   |       |    |          |                                      |       |    |  |
| VT1255A   | XB69- XC59-<br>EXTERNAL GLASS                     |  | KDR1279A   | XB693/695/613G LED<br>COMPLETE DOOR<br>KIT | <table border="1"> <thead> <tr> <th>Code</th> <th>Description</th> <th>Qty</th> <th>UOM</th> </tr> </thead> <tbody> <tr> <td>TB2404A0</td> <td>BAKERLUX<br/>CHEFLUX<br/>DOOR LOWER<br/>LISTEL</td> <td>1.000</td> <td>PC</td> </tr> <tr> <td>TB3092A0</td> <td>6TRAY<br/>BAKERTOP<br/>LEFT DOOR<br/>COLUMN</td> <td>1.000</td> <td>PC</td> </tr> <tr> <td>TB3096A0</td> <td>6TRAY<br/>BAKERTOP<br/>RIGHT DOOR<br/>COLUMN</td> <td>1.000</td> <td>PC</td> </tr> <tr> <td>VE1030A1</td> <td>MAGNET FOR<br/>DOOR<br/>MICROSWITC<br/>H D=22.9mm</td> <td>2.000</td> <td>PC</td> </tr> <tr> <td>VI0239A1</td> <td>SELF-TAPPIN<br/>G SCREW<br/>4.2X25 TCB+<br/>INOX</td> <td>4.000</td> <td>PC</td> </tr> <tr> <td>VI1070A0</td> <td>SCREW M4x16<br/>TSP/UNI7688<br/>INOX</td> <td>2.000</td> <td>PC</td> </tr> <tr> <td>VI1075A0</td> <td>NUT M4 H=4<br/>UNI5587 INOX</td> <td>2.000</td> <td>PC</td> </tr> <tr> <td>VI1220A1</td> <td>4,2x12 TCB<br/>SELF-TAPPIN<br/>G SCREW</td> <td>20.000</td> <td>PC</td> </tr> <tr> <td>VI1300A0</td> <td>SCREW M6X12<br/>T1/2T+INOX</td> <td>12.000</td> <td>PC</td> </tr> <tr> <td>VI1310A0</td> <td>ZINC THREAD<br/>INSERT M6<br/>FTR/E</td> <td>8.000</td> <td>PC</td> </tr> <tr> <td>VI1340A0</td> <td>M6 ST. STEEL<br/>THREADED<br/>INSERT</td> <td>4.000</td> <td>PC</td> </tr> <tr> <td>VI1810A0</td> <td>M6X6<br/>STAINLESS<br/>STEEL<br/>FLATHEAD<br/>SCREW</td> <td>6.000</td> <td>PC</td> </tr> <tr> <td>VM1490A0</td> <td>CHEFTOP/BAK<br/>ERTOP<br/>HANDLE<br/>SCREWS<br/>COVER</td> <td>2.000</td> <td>PC</td> </tr> <tr> <td>VM1510A0</td> <td>XBC/XVC<br/>GROOVED<br/>DOOR PIN<br/>BUSHING</td> <td>1.000</td> <td>PC</td> </tr> <tr> <td>VM1511A0</td> <td>XBC/XVC<br/>SLEEK DOOR<br/>PIN BUSHING</td> <td>1.000</td> <td>PC</td> </tr> </tbody> </table> | Code | Description | Qty | UOM | TB2404A0 | BAKERLUX<br>CHEFLUX<br>DOOR LOWER<br>LISTEL | 1.000 | PC | TB3092A0 | 6TRAY<br>BAKERTOP<br>LEFT DOOR<br>COLUMN | 1.000 | PC | TB3096A0 | 6TRAY<br>BAKERTOP<br>RIGHT DOOR<br>COLUMN | 1.000 | PC | VE1030A1 | MAGNET FOR<br>DOOR<br>MICROSWITC<br>H D=22.9mm | 2.000 | PC | VI0239A1 | SELF-TAPPIN<br>G SCREW<br>4.2X25 TCB+<br>INOX | 4.000 | PC | VI1070A0 | SCREW M4x16<br>TSP/UNI7688<br>INOX | 2.000 | PC | VI1075A0 | NUT M4 H=4<br>UNI5587 INOX | 2.000 | PC | VI1220A1 | 4,2x12 TCB<br>SELF-TAPPIN<br>G SCREW | 20.000 | PC | VI1300A0 | SCREW M6X12<br>T1/2T+INOX | 12.000 | PC | VI1310A0 | ZINC THREAD<br>INSERT M6<br>FTR/E | 8.000 | PC | VI1340A0 | M6 ST. STEEL<br>THREADED<br>INSERT | 4.000 | PC | VI1810A0 | M6X6<br>STAINLESS<br>STEEL<br>FLATHEAD<br>SCREW | 6.000 | PC | VM1490A0 | CHEFTOP/BAK<br>ERTOP<br>HANDLE<br>SCREWS<br>COVER | 2.000 | PC | VM1510A0 | XBC/XVC<br>GROOVED<br>DOOR PIN<br>BUSHING | 1.000 | PC | VM1511A0 | XBC/XVC<br>SLEEK DOOR<br>PIN BUSHING | 1.000 | PC |  |
| Code      | Description                                       | Qty   | UOM        |  |   |      |             |     |     |          |   |       |    |          |  |       |    |          |   |       |    |          |  |       |    |          |   |       |    |          |                                    |       |    |          |                            |       |    |          |                                      |        |    |          |                           |        |    |          |                                   |       |    |          |                                    |       |    |          |   |       |    |          |   |       |    |          |   |       |    |          |                                      |       |    |  |
| TB2404A0  | BAKERLUX<br>CHEFLUX<br>DOOR LOWER<br>LISTEL       | 1.000   | PC         |  |   |      |             |     |     |          |   |       |    |          |  |       |    |          |   |       |    |          |  |       |    |          |   |       |    |          |                                    |       |    |          |                            |       |    |          |                                      |        |    |          |                           |        |    |          |                                   |       |    |          |                                    |       |    |          |   |       |    |          |   |       |    |          |   |       |    |          |                                      |       |    |  |
| TB3092A0  | 6TRAY<br>BAKERTOP<br>LEFT DOOR<br>COLUMN          | 1.000   | PC         |  |   |      |             |     |     |          |   |       |    |          |  |       |    |          |   |       |    |          |  |       |    |          |   |       |    |          |                                    |       |    |          |                            |       |    |          |                                      |        |    |          |                           |        |    |          |                                   |       |    |          |                                    |       |    |          |   |       |    |          |   |       |    |          |   |       |    |          |                                      |       |    |  |
| TB3096A0  | 6TRAY<br>BAKERTOP<br>RIGHT DOOR<br>COLUMN         | 1.000   | PC         |  |   |      |             |     |     |          |   |       |    |          |  |       |    |          |   |       |    |          |  |       |    |          |   |       |    |          |                                    |       |    |          |                            |       |    |          |                                      |        |    |          |                           |        |    |          |                                   |       |    |          |                                    |       |    |          |   |       |    |          |   |       |    |          |   |       |    |          |                                      |       |    |  |
| VE1030A1  | MAGNET FOR<br>DOOR<br>MICROSWITC<br>H D=22.9mm    | 2.000   | PC         |  |   |      |             |     |     |          |   |       |    |          |  |       |    |          |   |       |    |          |  |       |    |          |   |       |    |          |                                    |       |    |          |                            |       |    |          |                                      |        |    |          |                           |        |    |          |                                   |       |    |          |                                    |       |    |          |   |       |    |          |   |       |    |          |   |       |    |          |                                      |       |    |  |
| VI0239A1  | SELF-TAPPIN<br>G SCREW<br>4.2X25 TCB+<br>INOX     | 4.000   | PC         |  |   |      |             |     |     |          |   |       |    |          |  |       |    |          |   |       |    |          |  |       |    |          |   |       |    |          |                                    |       |    |          |                            |       |    |          |                                      |        |    |          |                           |        |    |          |                                   |       |    |          |                                    |       |    |          |   |       |    |          |   |       |    |          |   |       |    |          |                                      |       |    |  |
| VI1070A0  | SCREW M4x16<br>TSP/UNI7688<br>INOX                | 2.000   | PC         |  |   |      |             |     |     |          |   |       |    |          |  |       |    |          |   |       |    |          |  |       |    |          |   |       |    |          |                                    |       |    |          |                            |       |    |          |                                      |        |    |          |                           |        |    |          |                                   |       |    |          |                                    |       |    |          |   |       |    |          |   |       |    |          |   |       |    |          |                                      |       |    |  |
| VI1075A0  | NUT M4 H=4<br>UNI5587 INOX                        | 2.000   | PC         |  |   |      |             |     |     |          |   |       |    |          |  |       |    |          |   |       |    |          |  |       |    |          |   |       |    |          |                                    |       |    |          |                            |       |    |          |                                      |        |    |          |                           |        |    |          |                                   |       |    |          |                                    |       |    |          |   |       |    |          |   |       |    |          |   |       |    |          |                                      |       |    |  |
| VI1220A1  | 4,2x12 TCB<br>SELF-TAPPIN<br>G SCREW              | 20.000  | PC         |  |   |      |             |     |     |          |   |       |    |          |  |       |    |          |   |       |    |          |  |       |    |          |   |       |    |          |                                    |       |    |          |                            |       |    |          |                                      |        |    |          |                           |        |    |          |                                   |       |    |          |                                    |       |    |          |   |       |    |          |   |       |    |          |   |       |    |          |                                      |       |    |  |
| VI1300A0  | SCREW M6X12<br>T1/2T+INOX                         | 12.000  | PC         |  |   |      |             |     |     |          |   |       |    |          |  |       |    |          |   |       |    |          |  |       |    |          |   |       |    |          |                                    |       |    |          |                            |       |    |          |                                      |        |    |          |                           |        |    |          |                                   |       |    |          |                                    |       |    |          |   |       |    |          |   |       |    |          |   |       |    |          |                                      |       |    |  |
| VI1310A0  | ZINC THREAD<br>INSERT M6<br>FTR/E                 | 8.000   | PC         |  |   |      |             |     |     |          |   |       |    |          |  |       |    |          |   |       |    |          |  |       |    |          |   |       |    |          |                                    |       |    |          |                            |       |    |          |                                      |        |    |          |                           |        |    |          |                                   |       |    |          |                                    |       |    |          |   |       |    |          |   |       |    |          |   |       |    |          |                                      |       |    |  |
| VI1340A0  | M6 ST. STEEL<br>THREADED<br>INSERT                | 4.000   | PC         |  |   |      |             |     |     |          |   |       |    |          |  |       |    |          |   |       |    |          |  |       |    |          |   |       |    |          |                                    |       |    |          |                            |       |    |          |                                      |        |    |          |                           |        |    |          |                                   |       |    |          |                                    |       |    |          |   |       |    |          |   |       |    |          |   |       |    |          |                                      |       |    |  |
| VI1810A0  | M6X6<br>STAINLESS<br>STEEL<br>FLATHEAD<br>SCREW   | 6.000   | PC         |  |   |      |             |     |     |          |   |       |    |          |  |       |    |          |   |       |    |          |  |       |    |          |   |       |    |          |                                    |       |    |          |                            |       |    |          |                                      |        |    |          |                           |        |    |          |                                   |       |    |          |                                    |       |    |          |   |       |    |          |   |       |    |          |   |       |    |          |                                      |       |    |  |
| VM1490A0  | CHEFTOP/BAK<br>ERTOP<br>HANDLE<br>SCREWS<br>COVER | 2.000   | PC         |  |   |      |             |     |     |          |   |       |    |          |  |       |    |          |   |       |    |          |  |       |    |          |   |       |    |          |                                    |       |    |          |                            |       |    |          |                                      |        |    |          |                           |        |    |          |                                   |       |    |          |                                    |       |    |          |   |       |    |          |   |       |    |          |   |       |    |          |                                      |       |    |  |
| VM1510A0  | XBC/XVC<br>GROOVED<br>DOOR PIN<br>BUSHING         | 1.000   | PC         |  |   |      |             |     |     |          |   |       |    |          |  |       |    |          |   |       |    |          |  |       |    |          |   |       |    |          |                                    |       |    |          |                            |       |    |          |                                      |        |    |          |                           |        |    |          |                                   |       |    |          |                                    |       |    |          |   |       |    |          |   |       |    |          |   |       |    |          |                                      |       |    |  |
| VM1511A0  | XBC/XVC<br>SLEEK DOOR<br>PIN BUSHING              | 1.000   | PC         |  |   |      |             |     |     |          |   |       |    |          |  |       |    |          |   |       |    |          |  |       |    |          |   |       |    |          |                                    |       |    |          |                            |       |    |          |                                      |        |    |          |                           |        |    |          |                                   |       |    |          |                                    |       |    |          |   |       |    |          |   |       |    |          |   |       |    |          |                                      |       |    |  |



| COMPONENT |                               |   | SPARE PART |  |                |   |            |            |
|-----------|-------------------------------|---|------------|--|----------------|---|------------|------------|
| Code      | Description                   | Image   | Code       | Description                                | Kit components |   |            |            |
| VT1255A   | XB69- XC59-<br>EXTERNAL GLASS |  | KDR1279A   | XB693/695/613G LED<br>COMPLETE DOOR<br>KIT | <b>Code</b>    | <b>Description</b>                                | <b>Qty</b> | <b>UOM</b> |
|           |                               |   |            |  | VM1620A0       | LED BAR<br>LOWER<br>SUPPORT                       | 1.000      | PC         |
|           |                               |   |            |  | VM1621A0       | LED BAR<br>UPPER<br>SUPPORT                       | 1.000      | PC         |
|           |                               |   |            |  | VM1680A0       | INTERNAL<br>GLASS HINGE                           | 2.000      | PC         |
|           |                               |   |            |  | VM1976A0       | CL BL DOOR<br>COLUMN<br>BLANKING CA               | 2.000      | PC         |
|           |                               |   |            |  | VM1977A0       | CL BL DOOR<br>UPPER<br>FULCRUM-CA                 | 1.000      | PC         |
|           |                               |   |            |  | VM1978A0       | CL BL DOOR<br>LOWER<br>FULCRUM-CA                 | 1.000      | PC         |
|           |                               |   |            |  | VM2000A0       | M4 SOCKET<br>HEAD SCREW<br>COVER                  | 6.000      | PC         |
|           |                               |   |            |  | VM2042A0       | INTERNAL<br>GLASS<br>LATERAL<br>LOCKING<br>SYSTEM | 2.000      | PC         |
|           |                               |   |            |  | VM2043A0       | UPPER -<br>LOWER<br>GLASS<br>SUPPORT              | 2.000      | PC         |
|           |                               |   |            |  | VT1135A0       | 743x620x6<br>INNER GLASS                          | 1.000      | PC         |
|           |                               |   |            |  | VT1255A0       | XB69- XC59-<br>EXTERNAL<br>GLASS                  | 1.000      | PC         |





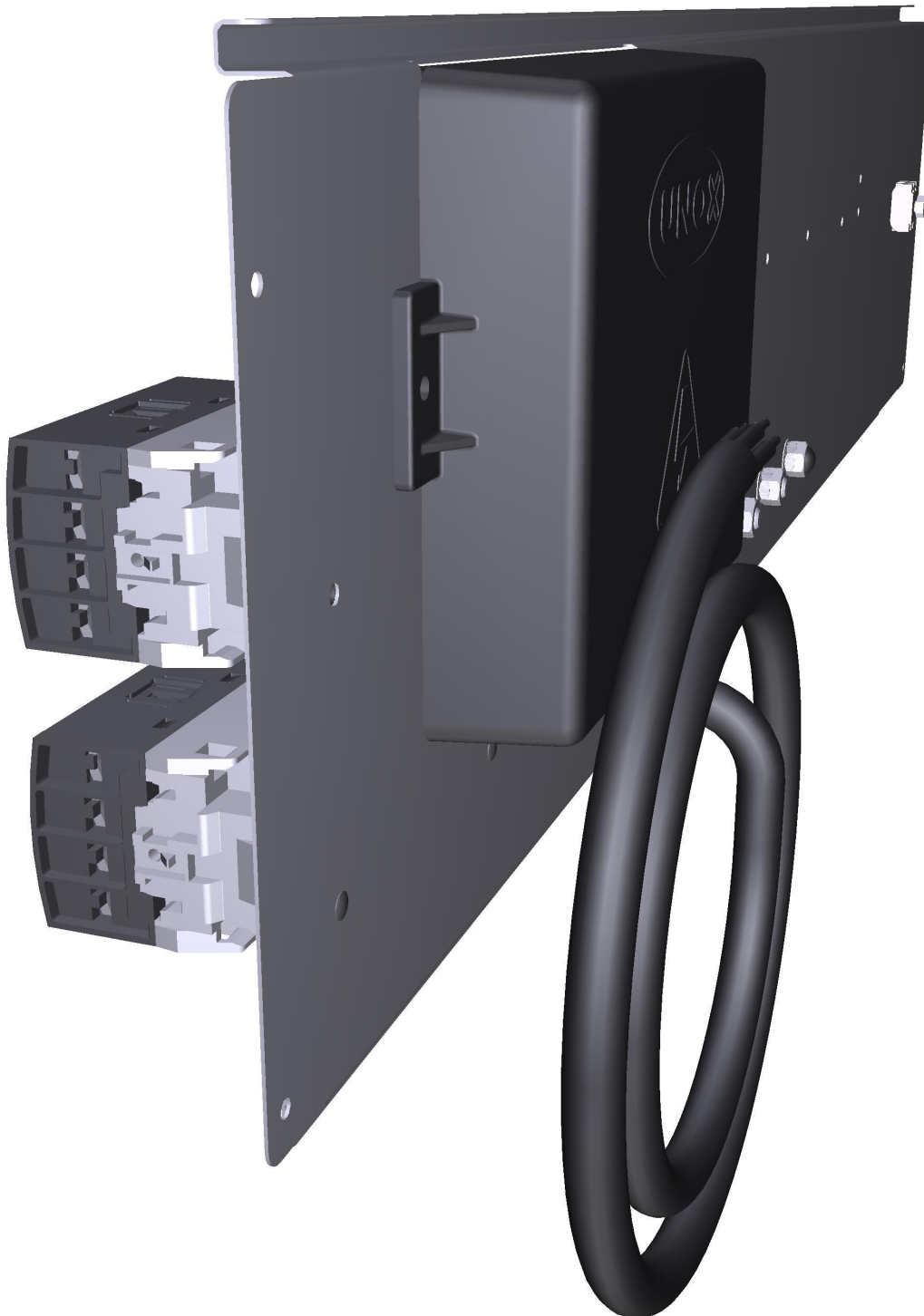

**ASM4098A/0.D00 - Electrical system - FRONT**

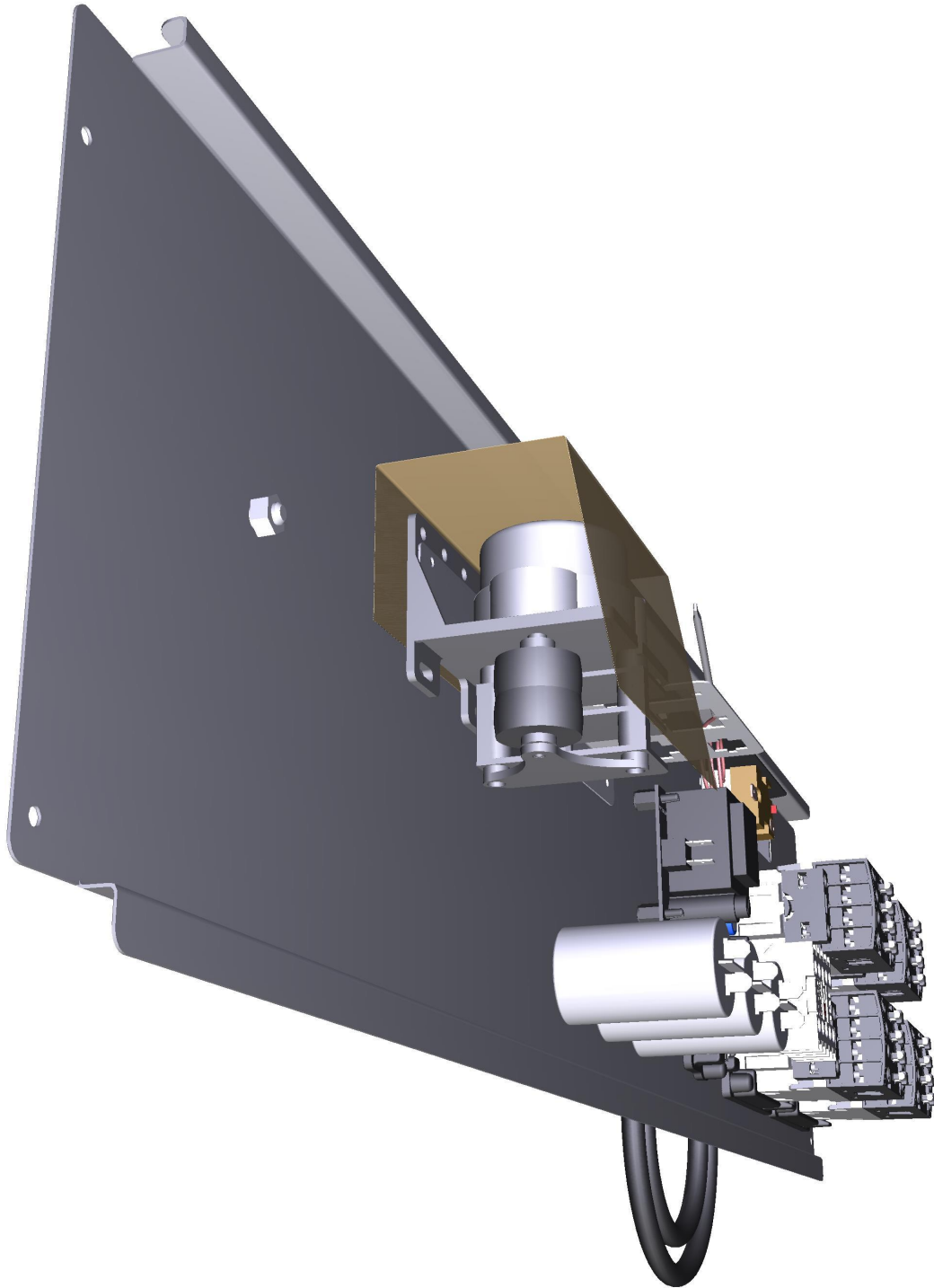



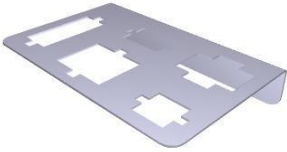

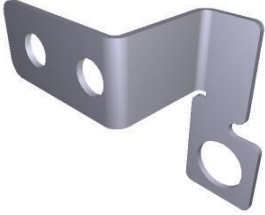
**ASM4098A/0.D00 - Electrical system - REAR**





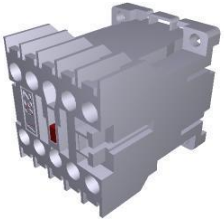

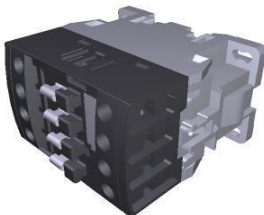
| COMPONENT |  |   | SPARE PART     |  |   |      |             |     |     |          |  |        |    |          |                              |       |    |          |  |       |    |
|-----------|--|---|----------------|--|---|------|-------------|-----|-----|----------|--|--------|----|----------|------------------------------|-------|----|----------|--|-------|----|
| Code      | Description  | Image   | Code           | Description                                    | Kit components  |      |             |     |     |          |  |        |    |          |                              |       |    |          |  |       |    |
| 0H6769B   | CONNECTOR<br>FIXING PANEL                          |    | 0H6769B0       | CONNECTOR<br>FIXING PANEL                      |   |      |             |     |     |          |  |        |    |          |                              |       |    |          |  |       |    |
| 0H6770C   | BAKER/CHEFLUX<br>ELEC.<br>COMPONENTS<br>HOLDER     |    | 0H6770C1       | BAKER/CHEFLUX<br>ELEC.<br>COMPONENTS<br>HOLDER |   |      |             |     |     |          |  |        |    |          |                              |       |    |          |  |       |    |
| 0H7293A   | GROUND<br>CONNECTOR<br>FIXING PLATE                |  | OUTOFPRODUCTIO | ITEM OUT OF<br>PRODUCTION                      |   |      |             |     |     |          |  |        |    |          |                              |       |    |          |  |       |    |
| VI1034A   | STAINLESS STEEL<br>WASHER 8.4x16x1                 |  | KVI1034A       | STAINLESS STEEL<br>WASHER 10 PCS KIT           | <table border="1"> <thead> <tr> <th>Code</th> <th>Description</th> <th>Qty</th> <th>UOM</th> </tr> </thead> <tbody> <tr> <td>VI1034A0</td> <td>STAINLESS<br/>STEEL<br/>WASHER<br/>8.4x16x1</td> <td>10.000</td> <td>PC</td> </tr> </tbody> </table>   | Code | Description | Qty | UOM | VI1034A0 | STAINLESS<br>STEEL<br>WASHER<br>8.4x16x1 | 10.000 | PC |          |                              |       |    |          |  |       |    |
| Code      | Description  | Qty   | UOM            |  |   |      |             |     |     |          |  |        |    |          |                              |       |    |          |  |       |    |
| VI1034A0  | STAINLESS<br>STEEL<br>WASHER<br>8.4x16x1           | 10.000  | PC             |  |   |      |             |     |     |          |  |        |    |          |                              |       |    |          |  |       |    |
| VE1615A   | MOTOR REVERSING<br>SWITCH                          |  | KVE1615A       | MOTOR REVERSING<br>SWITCH KIT                  | <table border="1"> <thead> <tr> <th>Code</th> <th>Description</th> <th>Qty</th> <th>UOM</th> </tr> </thead> <tbody> <tr> <td>0H1429A0</td> <td>VE1615A<br/>INVERTER<br/>FIXING PLATE</td> <td>1.000</td> <td>PC</td> </tr> <tr> <td>VE1615A0</td> <td>MOTOR<br/>REVERSING<br/>SWITCH</td> <td>1.000</td> <td>PC</td> </tr> <tr> <td>VI1960A1</td> <td>4.2X9.5<br/>CROSS ZN-NI<br/>SELF-THREADI<br/>NG SCREW</td> <td>3.000</td> <td>PC</td> </tr> </tbody> </table> | Code | Description | Qty | UOM | 0H1429A0 | VE1615A<br>INVERTER<br>FIXING PLATE      | 1.000  | PC | VE1615A0 | MOTOR<br>REVERSING<br>SWITCH | 1.000 | PC | VI1960A1 | 4.2X9.5<br>CROSS ZN-NI<br>SELF-THREADI<br>NG SCREW | 3.000 | PC |
| Code      | Description  | Qty   | UOM            |  |   |      |             |     |     |          |  |        |    |          |                              |       |    |          |  |       |    |
| 0H1429A0  | VE1615A<br>INVERTER<br>FIXING PLATE                | 1.000   | PC             |  |   |      |             |     |     |          |  |        |    |          |                              |       |    |          |  |       |    |
| VE1615A0  | MOTOR<br>REVERSING<br>SWITCH                       | 1.000   | PC             |  |   |      |             |     |     |          |  |        |    |          |                              |       |    |          |  |       |    |
| VI1960A1  | 4.2X9.5<br>CROSS ZN-NI<br>SELF-THREADI<br>NG SCREW | 3.000   | PC             |  |   |      |             |     |     |          |  |        |    |          |                              |       |    |          |  |       |    |



| COMPONENT   |                                  |   | SPARE PART |                                    |   |                                |             |     |          |                               |                                  |       |          |                               |                                |       |          |                                |                               |       |          |                                |                                |       |          |                          |                                |       |    |          |                          |       |    |
|---|----------------------------------|---|------------|------------------------------------|---|--------------------------------|-------------|-----|----------|-------------------------------|----------------------------------|-------|----------|-------------------------------|--------------------------------|-------|----------|--------------------------------|-------------------------------|-------|----------|--------------------------------|--------------------------------|-------|----------|--------------------------|--------------------------------|-------|----|----------|--------------------------|-------|----|
| Code  | Description                      | Image   | Code       | Description                        | Kit components  |                                |             |     |          |                               |                                  |       |          |                               |                                |       |          |                                |                               |       |          |                                |                                |       |          |                          |                                |       |    |          |                          |       |    |
| VE1115A   | 20 A 230V 4 POLES MINICONTRACTOR |    | KVE1115A   | 20A 230V 4 POLES MINICONTRACTOR KI | <table border="1"> <thead> <tr> <th>Code</th> <th>Description</th> <th>Qty</th> <th>UOM</th> </tr> </thead> <tbody> <tr> <td>VE1115A0</td> <td>20 A 230V 4 POLES MINICONTRACTOR</td> <td>1.000</td> <td>PC</td> </tr> <tr> <td>VM1075A1</td> <td>PLASTIC CLIP TO FIX CONTACTORS</td> <td>4.000</td> <td>PC</td> </tr> </tbody> </table>   | Code                           | Description | Qty | UOM      | VE1115A0                      | 20 A 230V 4 POLES MINICONTRACTOR | 1.000 | PC       | VM1075A1                      | PLASTIC CLIP TO FIX CONTACTORS | 4.000 | PC       |                                |                               |       |          |                                |                                |       |          |                          |                                |       |    |          |                          |       |    |
|   |                                  |   |            |                                    | Code  | Description                    | Qty         | UOM |          |                               |                                  |       |          |                               |                                |       |          |                                |                               |       |          |                                |                                |       |          |                          |                                |       |    |          |                          |       |    |
| VE1115A0  | 20 A 230V 4 POLES MINICONTRACTOR | 1.000   | PC         |                                    |   |                                |             |     |          |                               |                                  |       |          |                               |                                |       |          |                                |                               |       |          |                                |                                |       |          |                          |                                |       |    |          |                          |       |    |
| VM1075A1  | PLASTIC CLIP TO FIX CONTACTORS   | 4.000   | PC         |                                    |   |                                |             |     |          |                               |                                  |       |          |                               |                                |       |          |                                |                               |       |          |                                |                                |       |          |                          |                                |       |    |          |                          |       |    |
| <table border="1"> <thead> <tr> <th>Code</th> <th>Description</th> <th>Qty</th> <th>UOM</th> </tr> </thead> <tbody> <tr> <td>CE1455A0</td> <td>TIP END FITTING</td> <td>2.000</td> <td>PC</td> </tr> <tr> <td>CE1560A0</td> <td>BALCK UNIP AWG18 ST.3135 WIRE</td> <td>0.250</td> <td>M</td> </tr> <tr> <td>VE2000A0</td> <td>50/60HZ 230V 30A 4P CONTACTOR</td> <td>1.000</td> <td>PC</td> </tr> <tr> <td>VI1220A1</td> <td>4,2x12 TCB SELF-TAPPIN G SCREW</td> <td>2.000</td> <td>PC</td> </tr> <tr> <td>VM1075A1</td> <td>PLASTIC CLIP TO FIX CONTACTORS</td> <td>4.000</td> <td>PC</td> </tr> <tr> <td>VM2191A1</td> <td>VE1095 CONTACTOR BRACKET</td> <td>1.000</td> <td>PC</td> </tr> </tbody> </table> | Code                             | Description   | Qty        | UOM                                | CE1455A0  | TIP END FITTING                | 2.000       | PC  | CE1560A0 | BALCK UNIP AWG18 ST.3135 WIRE | 0.250                            | M     | VE2000A0 | 50/60HZ 230V 30A 4P CONTACTOR | 1.000                          | PC    | VI1220A1 | 4,2x12 TCB SELF-TAPPIN G SCREW | 2.000                         | PC    | VM1075A1 | PLASTIC CLIP TO FIX CONTACTORS | 4.000                          | PC    | VM2191A1 | VE1095 CONTACTOR BRACKET | 1.000                          | PC    |    |          |                          |       |    |
| Code  | Description                      | Qty   | UOM        |                                    |   |                                |             |     |          |                               |                                  |       |          |                               |                                |       |          |                                |                               |       |          |                                |                                |       |          |                          |                                |       |    |          |                          |       |    |
| CE1455A0  | TIP END FITTING                  | 2.000   | PC         |                                    |   |                                |             |     |          |                               |                                  |       |          |                               |                                |       |          |                                |                               |       |          |                                |                                |       |          |                          |                                |       |    |          |                          |       |    |
| CE1560A0  | BALCK UNIP AWG18 ST.3135 WIRE    | 0.250   | M          |                                    |   |                                |             |     |          |                               |                                  |       |          |                               |                                |       |          |                                |                               |       |          |                                |                                |       |          |                          |                                |       |    |          |                          |       |    |
| VE2000A0  | 50/60HZ 230V 30A 4P CONTACTOR    | 1.000   | PC         |                                    |   |                                |             |     |          |                               |                                  |       |          |                               |                                |       |          |                                |                               |       |          |                                |                                |       |          |                          |                                |       |    |          |                          |       |    |
| VI1220A1  | 4,2x12 TCB SELF-TAPPIN G SCREW   | 2.000   | PC         |                                    |   |                                |             |     |          |                               |                                  |       |          |                               |                                |       |          |                                |                               |       |          |                                |                                |       |          |                          |                                |       |    |          |                          |       |    |
| VM1075A1  | PLASTIC CLIP TO FIX CONTACTORS   | 4.000   | PC         |                                    |   |                                |             |     |          |                               |                                  |       |          |                               |                                |       |          |                                |                               |       |          |                                |                                |       |          |                          |                                |       |    |          |                          |       |    |
| VM2191A1  | VE1095 CONTACTOR BRACKET         | 1.000   | PC         |                                    |   |                                |             |     |          |                               |                                  |       |          |                               |                                |       |          |                                |                               |       |          |                                |                                |       |          |                          |                                |       |    |          |                          |       |    |
| VM1056A   | SMALL CONTACTOR BRACKET VE1115A  |    | VM1056A0   | SMALL CONTACTOR BRACKET VE1115A    |   |                                |             |     |          |                               |                                  |       |          |                               |                                |       |          |                                |                               |       |          |                                |                                |       |          |                          |                                |       |    |          |                          |       |    |
| VE2000A   | 50/60HZ 230V 30A 4P CONTACTOR    |  | KVE2000A   | 50/60HZ 230V 30A 4P CONTACTOR KIT  | <table border="1"> <thead> <tr> <th>Code</th> <th>Description</th> <th>Qty</th> <th>UOM</th> </tr> </thead> <tbody> <tr> <td>CE1455A0</td> <td>TIP END FITTING</td> <td>2.000</td> <td>PC</td> </tr> <tr> <td>CE1560A0</td> <td>BALCK UNIP AWG18 ST.3135 WIRE</td> <td>0.250</td> <td>M</td> </tr> <tr> <td>VE2000A0</td> <td>50/60HZ 230V 30A 4P CONTACTOR</td> <td>1.000</td> <td>PC</td> </tr> <tr> <td>VI1220A1</td> <td>4,2x12 TCB SELF-TAPPIN G SCREW</td> <td>2.000</td> <td>PC</td> </tr> <tr> <td>VM1075A1</td> <td>PLASTIC CLIP TO FIX CONTACTORS</td> <td>4.000</td> <td>PC</td> </tr> <tr> <td>VM2191A1</td> <td>VE1095 CONTACTOR BRACKET</td> <td>1.000</td> <td>PC</td> </tr> </tbody> </table> | Code                           | Description | Qty | UOM      | CE1455A0                      | TIP END FITTING                  | 2.000 | PC       | CE1560A0                      | BALCK UNIP AWG18 ST.3135 WIRE  | 0.250 | M        | VE2000A0                       | 50/60HZ 230V 30A 4P CONTACTOR | 1.000 | PC       | VI1220A1                       | 4,2x12 TCB SELF-TAPPIN G SCREW | 2.000 | PC       | VM1075A1                 | PLASTIC CLIP TO FIX CONTACTORS | 4.000 | PC | VM2191A1 | VE1095 CONTACTOR BRACKET | 1.000 | PC |
|   |                                  |   |            |                                    | Code  | Description                    | Qty         | UOM |          |                               |                                  |       |          |                               |                                |       |          |                                |                               |       |          |                                |                                |       |          |                          |                                |       |    |          |                          |       |    |
|   |                                  |   |            |                                    | CE1455A0  | TIP END FITTING                | 2.000       | PC  |          |                               |                                  |       |          |                               |                                |       |          |                                |                               |       |          |                                |                                |       |          |                          |                                |       |    |          |                          |       |    |
|   |                                  |   |            |                                    | CE1560A0  | BALCK UNIP AWG18 ST.3135 WIRE  | 0.250       | M   |          |                               |                                  |       |          |                               |                                |       |          |                                |                               |       |          |                                |                                |       |          |                          |                                |       |    |          |                          |       |    |
|   |                                  |   |            |                                    | VE2000A0  | 50/60HZ 230V 30A 4P CONTACTOR  | 1.000       | PC  |          |                               |                                  |       |          |                               |                                |       |          |                                |                               |       |          |                                |                                |       |          |                          |                                |       |    |          |                          |       |    |
|   |                                  |   |            |                                    | VI1220A1  | 4,2x12 TCB SELF-TAPPIN G SCREW | 2.000       | PC  |          |                               |                                  |       |          |                               |                                |       |          |                                |                               |       |          |                                |                                |       |          |                          |                                |       |    |          |                          |       |    |
|   |                                  |   |            |                                    | VM1075A1  | PLASTIC CLIP TO FIX CONTACTORS | 4.000       | PC  |          |                               |                                  |       |          |                               |                                |       |          |                                |                               |       |          |                                |                                |       |          |                          |                                |       |    |          |                          |       |    |
| VM2191A1  | VE1095 CONTACTOR BRACKET         | 1.000   | PC         |                                    |   |                                |             |     |          |                               |                                  |       |          |                               |                                |       |          |                                |                               |       |          |                                |                                |       |          |                          |                                |       |    |          |                          |       |    |
| <table border="1"> <thead> <tr> <th>Code</th> <th>Description</th> <th>Qty</th> <th>UOM</th> </tr> </thead> <tbody> <tr> <td>CE1455A0</td> <td>TIP END FITTING</td> <td>2.000</td> <td>PC</td> </tr> <tr> <td>CE1560A0</td> <td>BALCK UNIP AWG18 ST.3135 WIRE</td> <td>0.250</td> <td>M</td> </tr> <tr> <td>VE2000A0</td> <td>50/60HZ 230V 30A 4P CONTACTOR</td> <td>1.000</td> <td>PC</td> </tr> <tr> <td>VI1220A1</td> <td>4,2x12 TCB SELF-TAPPIN G SCREW</td> <td>2.000</td> <td>PC</td> </tr> <tr> <td>VM1075A1</td> <td>PLASTIC CLIP TO FIX CONTACTORS</td> <td>4.000</td> <td>PC</td> </tr> <tr> <td>VM2191A1</td> <td>VE1095 CONTACTOR BRACKET</td> <td>1.000</td> <td>PC</td> </tr> </tbody> </table> | Code                             | Description   | Qty        | UOM                                | CE1455A0  | TIP END FITTING                | 2.000       | PC  | CE1560A0 | BALCK UNIP AWG18 ST.3135 WIRE | 0.250                            | M     | VE2000A0 | 50/60HZ 230V 30A 4P CONTACTOR | 1.000                          | PC    | VI1220A1 | 4,2x12 TCB SELF-TAPPIN G SCREW | 2.000                         | PC    | VM1075A1 | PLASTIC CLIP TO FIX CONTACTORS | 4.000                          | PC    | VM2191A1 | VE1095 CONTACTOR BRACKET | 1.000                          | PC    |    |          |                          |       |    |
| Code  | Description                      | Qty   | UOM        |                                    |   |                                |             |     |          |                               |                                  |       |          |                               |                                |       |          |                                |                               |       |          |                                |                                |       |          |                          |                                |       |    |          |                          |       |    |
| CE1455A0  | TIP END FITTING                  | 2.000   | PC         |                                    |   |                                |             |     |          |                               |                                  |       |          |                               |                                |       |          |                                |                               |       |          |                                |                                |       |          |                          |                                |       |    |          |                          |       |    |
| CE1560A0  | BALCK UNIP AWG18 ST.3135 WIRE    | 0.250   | M          |                                    |   |                                |             |     |          |                               |                                  |       |          |                               |                                |       |          |                                |                               |       |          |                                |                                |       |          |                          |                                |       |    |          |                          |       |    |
| VE2000A0  | 50/60HZ 230V 30A 4P CONTACTOR    | 1.000   | PC         |                                    |   |                                |             |     |          |                               |                                  |       |          |                               |                                |       |          |                                |                               |       |          |                                |                                |       |          |                          |                                |       |    |          |                          |       |    |
| VI1220A1  | 4,2x12 TCB SELF-TAPPIN G SCREW   | 2.000   | PC         |                                    |   |                                |             |     |          |                               |                                  |       |          |                               |                                |       |          |                                |                               |       |          |                                |                                |       |          |                          |                                |       |    |          |                          |       |    |
| VM1075A1  | PLASTIC CLIP TO FIX CONTACTORS   | 4.000   | PC         |                                    |   |                                |             |     |          |                               |                                  |       |          |                               |                                |       |          |                                |                               |       |          |                                |                                |       |          |                          |                                |       |    |          |                          |       |    |
| VM2191A1  | VE1095 CONTACTOR BRACKET         | 1.000   | PC         |                                    |   |                                |             |     |          |                               |                                  |       |          |                               |                                |       |          |                                |                               |       |          |                                |                                |       |          |                          |                                |       |    |          |                          |       |    |
| <table border="1"> <thead> <tr> <th>Code</th> <th>Description</th> <th>Qty</th> <th>UOM</th> </tr> </thead> <tbody> <tr> <td>CE1455A0</td> <td>TIP END FITTING</td> <td>2.000</td> <td>PC</td> </tr> <tr> <td>CE1560A0</td> <td>BALCK UNIP AWG18 ST.3135 WIRE</td> <td>0.250</td> <td>M</td> </tr> <tr> <td>VE2000A0</td> <td>50/60HZ 230V 30A 4P CONTACTOR</td> <td>1.000</td> <td>PC</td> </tr> <tr> <td>VI1220A1</td> <td>4,2x12 TCB SELF-TAPPIN G SCREW</td> <td>2.000</td> <td>PC</td> </tr> <tr> <td>VM1075A1</td> <td>PLASTIC CLIP TO FIX CONTACTORS</td> <td>4.000</td> <td>PC</td> </tr> <tr> <td>VM2191A1</td> <td>VE1095 CONTACTOR BRACKET</td> <td>1.000</td> <td>PC</td> </tr> </tbody> </table> | Code                             | Description   | Qty        | UOM                                | CE1455A0  | TIP END FITTING                | 2.000       | PC  | CE1560A0 | BALCK UNIP AWG18 ST.3135 WIRE | 0.250                            | M     | VE2000A0 | 50/60HZ 230V 30A 4P CONTACTOR | 1.000                          | PC    | VI1220A1 | 4,2x12 TCB SELF-TAPPIN G SCREW | 2.000                         | PC    | VM1075A1 | PLASTIC CLIP TO FIX CONTACTORS | 4.000                          | PC    | VM2191A1 | VE1095 CONTACTOR BRACKET | 1.000                          | PC    |    |          |                          |       |    |
| Code  | Description                      | Qty   | UOM        |                                    |   |                                |             |     |          |                               |                                  |       |          |                               |                                |       |          |                                |                               |       |          |                                |                                |       |          |                          |                                |       |    |          |                          |       |    |
| CE1455A0  | TIP END FITTING                  | 2.000   | PC         |                                    |   |                                |             |     |          |                               |                                  |       |          |                               |                                |       |          |                                |                               |       |          |                                |                                |       |          |                          |                                |       |    |          |                          |       |    |
| CE1560A0  | BALCK UNIP AWG18 ST.3135 WIRE    | 0.250   | M          |                                    |   |                                |             |     |          |                               |                                  |       |          |                               |                                |       |          |                                |                               |       |          |                                |                                |       |          |                          |                                |       |    |          |                          |       |    |
| VE2000A0  | 50/60HZ 230V 30A 4P CONTACTOR    | 1.000   | PC         |                                    |   |                                |             |     |          |                               |                                  |       |          |                               |                                |       |          |                                |                               |       |          |                                |                                |       |          |                          |                                |       |    |          |                          |       |    |
| VI1220A1  | 4,2x12 TCB SELF-TAPPIN G SCREW   | 2.000   | PC         |                                    |   |                                |             |     |          |                               |                                  |       |          |                               |                                |       |          |                                |                               |       |          |                                |                                |       |          |                          |                                |       |    |          |                          |       |    |
| VM1075A1  | PLASTIC CLIP TO FIX CONTACTORS   | 4.000   | PC         |                                    |   |                                |             |     |          |                               |                                  |       |          |                               |                                |       |          |                                |                               |       |          |                                |                                |       |          |                          |                                |       |    |          |                          |       |    |
| VM2191A1  | VE1095 CONTACTOR BRACKET         | 1.000   | PC         |                                    |   |                                |             |     |          |                               |                                  |       |          |                               |                                |       |          |                                |                               |       |          |                                |                                |       |          |                          |                                |       |    |          |                          |       |    |
| <table border="1"> <thead> <tr> <th>Code</th> <th>Description</th> <th>Qty</th> <th>UOM</th> </tr> </thead> <tbody> <tr> <td>CE1455A0</td> <td>TIP END FITTING</td> <td>2.000</td> <td>PC</td> </tr> <tr> <td>CE1560A0</td> <td>BALCK UNIP AWG18 ST.3135 WIRE</td> <td>0.250</td> <td>M</td> </tr> <tr> <td>VE2000A0</td> <td>50/60HZ 230V 30A 4P CONTACTOR</td> <td>1.000</td> <td>PC</td> </tr> <tr> <td>VI1220A1</td> <td>4,2x12 TCB SELF-TAPPIN G SCREW</td> <td>2.000</td> <td>PC</td> </tr> <tr> <td>VM1075A1</td> <td>PLASTIC CLIP TO FIX CONTACTORS</td> <td>4.000</td> <td>PC</td> </tr> <tr> <td>VM2191A1</td> <td>VE1095 CONTACTOR BRACKET</td> <td>1.000</td> <td>PC</td> </tr> </tbody> </table> | Code                             | Description   | Qty        | UOM                                | CE1455A0  | TIP END FITTING                | 2.000       | PC  | CE1560A0 | BALCK UNIP AWG18 ST.3135 WIRE | 0.250                            | M     | VE2000A0 | 50/60HZ 230V 30A 4P CONTACTOR | 1.000                          | PC    | VI1220A1 | 4,2x12 TCB SELF-TAPPIN G SCREW | 2.000                         | PC    | VM1075A1 | PLASTIC CLIP TO FIX CONTACTORS | 4.000                          | PC    | VM2191A1 | VE1095 CONTACTOR BRACKET | 1.000                          | PC    |    |          |                          |       |    |
| Code  | Description                      | Qty   | UOM        |                                    |   |                                |             |     |          |                               |                                  |       |          |                               |                                |       |          |                                |                               |       |          |                                |                                |       |          |                          |                                |       |    |          |                          |       |    |
| CE1455A0  | TIP END FITTING                  | 2.000   | PC         |                                    |   |                                |             |     |          |                               |                                  |       |          |                               |                                |       |          |                                |                               |       |          |                                |                                |       |          |                          |                                |       |    |          |                          |       |    |
| CE1560A0  | BALCK UNIP AWG18 ST.3135 WIRE    | 0.250   | M          |                                    |   |                                |             |     |          |                               |                                  |       |          |                               |                                |       |          |                                |                               |       |          |                                |                                |       |          |                          |                                |       |    |          |                          |       |    |
| VE2000A0  | 50/60HZ 230V 30A 4P CONTACTOR    | 1.000   | PC         |                                    |   |                                |             |     |          |                               |                                  |       |          |                               |                                |       |          |                                |                               |       |          |                                |                                |       |          |                          |                                |       |    |          |                          |       |    |
| VI1220A1  | 4,2x12 TCB SELF-TAPPIN G SCREW   | 2.000   | PC         |                                    |   |                                |             |     |          |                               |                                  |       |          |                               |                                |       |          |                                |                               |       |          |                                |                                |       |          |                          |                                |       |    |          |                          |       |    |
| VM1075A1  | PLASTIC CLIP TO FIX CONTACTORS   | 4.000   | PC         |                                    |   |                                |             |     |          |                               |                                  |       |          |                               |                                |       |          |                                |                               |       |          |                                |                                |       |          |                          |                                |       |    |          |                          |       |    |
| VM2191A1  | VE1095 CONTACTOR BRACKET         | 1.000   | PC         |                                    |   |                                |             |     |          |                               |                                  |       |          |                               |                                |       |          |                                |                               |       |          |                                |                                |       |          |                          |                                |       |    |          |                          |       |    |
| <table border="1"> <thead> <tr> <th>Code</th> <th>Description</th> <th>Qty</th> <th>UOM</th> </tr> </thead> <tbody> <tr> <td>CE1455A0</td> <td>TIP END FITTING</td> <td>2.000</td> <td>PC</td> </tr> <tr> <td>CE1560A0</td> <td>BALCK UNIP AWG18 ST.3135 WIRE</td> <td>0.250</td> <td>M</td> </tr> <tr> <td>VE2000A0</td> <td>50/60HZ 230V 30A 4P CONTACTOR</td> <td>1.000</td> <td>PC</td> </tr> <tr> <td>VI1220A1</td> <td>4,2x12 TCB SELF-TAPPIN G SCREW</td> <td>2.000</td> <td>PC</td> </tr> <tr> <td>VM1075A1</td> <td>PLASTIC CLIP TO FIX CONTACTORS</td> <td>4.000</td> <td>PC</td> </tr> <tr> <td>VM2191A1</td> <td>VE1095 CONTACTOR BRACKET</td> <td>1.000</td> <td>PC</td> </tr> </tbody> </table> | Code                             | Description   | Qty        | UOM                                | CE1455A0  | TIP END FITTING                | 2.000       | PC  | CE1560A0 | BALCK UNIP AWG18 ST.3135 WIRE | 0.250                            | M     | VE2000A0 | 50/60HZ 230V 30A 4P CONTACTOR | 1.000                          | PC    | VI1220A1 | 4,2x12 TCB SELF-TAPPIN G SCREW | 2.000                         | PC    | VM1075A1 | PLASTIC CLIP TO FIX CONTACTORS | 4.000                          | PC    | VM2191A1 | VE1095 CONTACTOR BRACKET | 1.000                          | PC    |    |          |                          |       |    |
| Code  | Description                      | Qty   | UOM        |                                    |   |                                |             |     |          |                               |                                  |       |          |                               |                                |       |          |                                |                               |       |          |                                |                                |       |          |                          |                                |       |    |          |                          |       |    |
| CE1455A0  | TIP END FITTING                  | 2.000   | PC         |                                    |   |                                |             |     |          |                               |                                  |       |          |                               |                                |       |          |                                |                               |       |          |                                |                                |       |          |                          |                                |       |    |          |                          |       |    |
| CE1560A0  | BALCK UNIP AWG18 ST.3135 WIRE    | 0.250   | M          |                                    |   |                                |             |     |          |                               |                                  |       |          |                               |                                |       |          |                                |                               |       |          |                                |                                |       |          |                          |                                |       |    |          |                          |       |    |
| VE2000A0  | 50/60HZ 230V 30A 4P CONTACTOR    | 1.000   | PC         |                                    |   |                                |             |     |          |                               |                                  |       |          |                               |                                |       |          |                                |                               |       |          |                                |                                |       |          |                          |                                |       |    |          |                          |       |    |
| VI1220A1  | 4,2x12 TCB SELF-TAPPIN G SCREW   | 2.000   | PC         |                                    |   |                                |             |     |          |                               |                                  |       |          |                               |                                |       |          |                                |                               |       |          |                                |                                |       |          |                          |                                |       |    |          |                          |       |    |
| VM1075A1  | PLASTIC CLIP TO FIX CONTACTORS   | 4.000   | PC         |                                    |   |                                |             |     |          |                               |                                  |       |          |                               |                                |       |          |                                |                               |       |          |                                |                                |       |          |                          |                                |       |    |          |                          |       |    |
| VM2191A1  | VE1095 CONTACTOR BRACKET         | 1.000   | PC         |                                    |   |                                |             |     |          |                               |                                  |       |          |                               |                                |       |          |                                |                               |       |          |                                |                                |       |          |                          |                                |       |    |          |                          |       |    |
| <table border="1"> <thead> <tr> <th>Code</th> <th>Description</th> <th>Qty</th> <th>UOM</th> </tr> </thead> <tbody> <tr> <td>CE1455A0</td> <td>TIP END FITTING</td> <td>2.000</td> <td>PC</td> </tr> <tr> <td>CE1560A0</td> <td>BALCK UNIP AWG18 ST.3135 WIRE</td> <td>0.250</td> <td>M</td> </tr> <tr> <td>VE2000A0</td> <td>50/60HZ 230V 30A 4P CONTACTOR</td> <td>1.000</td> <td>PC</td> </tr> <tr> <td>VI1220A1</td> <td>4,2x12 TCB SELF-TAPPIN G SCREW</td> <td>2.000</td> <td>PC</td> </tr> <tr> <td>VM1075A1</td> <td>PLASTIC CLIP TO FIX CONTACTORS</td> <td>4.000</td> <td>PC</td> </tr> <tr> <td>VM2191A1</td> <td>VE1095 CONTACTOR BRACKET</td> <td>1.000</td> <td>PC</td> </tr> </tbody> </table> | Code                             | Description   | Qty        | UOM                                | CE1455A0  | TIP END FITTING                | 2.000       | PC  | CE1560A0 | BALCK UNIP AWG18 ST.3135 WIRE | 0.250                            | M     | VE2000A0 | 50/60HZ 230V 30A 4P CONTACTOR | 1.000                          | PC    | VI1220A1 | 4,2x12 TCB SELF-TAPPIN G SCREW | 2.000                         | PC    | VM1075A1 | PLASTIC CLIP TO FIX CONTACTORS | 4.000                          | PC    | VM2191A1 | VE1095 CONTACTOR BRACKET | 1.000                          | PC    |    |          |                          |       |    |
| Code  | Description                      | Qty   | UOM        |                                    |   |                                |             |     |          |                               |                                  |       |          |                               |                                |       |          |                                |                               |       |          |                                |                                |       |          |                          |                                |       |    |          |                          |       |    |
| CE1455A0  | TIP END FITTING                  | 2.000   | PC         |                                    |   |                                |             |     |          |                               |                                  |       |          |                               |                                |       |          |                                |                               |       |          |                                |                                |       |          |                          |                                |       |    |          |                          |       |    |
| CE1560A0  | BALCK UNIP AWG18 ST.3135 WIRE    | 0.250   | M          |                                    |   |                                |             |     |          |                               |                                  |       |          |                               |                                |       |          |                                |                               |       |          |                                |                                |       |          |                          |                                |       |    |          |                          |       |    |
| VE2000A0  | 50/60HZ 230V 30A 4P CONTACTOR    | 1.000   | PC         |                                    |   |                                |             |     |          |                               |                                  |       |          |                               |                                |       |          |                                |                               |       |          |                                |                                |       |          |                          |                                |       |    |          |                          |       |    |
| VI1220A1  | 4,2x12 TCB SELF-TAPPIN G SCREW   | 2.000   | PC         |                                    |   |                                |             |     |          |                               |                                  |       |          |                               |                                |       |          |                                |                               |       |          |                                |                                |       |          |                          |                                |       |    |          |                          |       |    |
| VM1075A1  | PLASTIC CLIP TO FIX CONTACTORS   | 4.000   | PC         |                                    |   |                                |             |     |          |                               |                                  |       |          |                               |                                |       |          |                                |                               |       |          |                                |                                |       |          |                          |                                |       |    |          |                          |       |    |
| VM2191A1  | VE1095 CONTACTOR BRACKET         | 1.000   | PC         |                                    |   |                                |             |     |          |                               |                                  |       |          |                               |                                |       |          |                                |                               |       |          |                                |                                |       |          |                          |                                |       |    |          |                          |       |    |
| <table border="1"> <thead> <tr> <th>Code</th> <th>Description</th> <th>Qty</th> <th>UOM</th> </tr> </thead> <tbody> <tr> <td>CE1455A0</td> <td>TIP END FITTING</td> <td>2.000</td> <td>PC</td> </tr> <tr> <td>CE1560A0</td> <td>BALCK UNIP AWG18 ST.3135 WIRE</td> <td>0.250</td> <td>M</td> </tr> <tr> <td>VE2000A0</td> <td>50/60HZ 230V 30A 4P CONTACTOR</td> <td>1.000</td> <td>PC</td> </tr> <tr> <td>VI1220A1</td> <td>4,2x12 TCB SELF-TAPPIN G SCREW</td> <td>2.000</td> <td>PC</td> </tr> <tr> <td>VM1075A1</td> <td>PLASTIC CLIP TO FIX CONTACTORS</td> <td>4.000</td> <td>PC</td> </tr> <tr> <td>VM2191A1</td> <td>VE1095 CONTACTOR BRACKET</td> <td>1.000</td> <td>PC</td> </tr> </tbody> </table> | Code                             | Description   | Qty        | UOM                                | CE1455A0  | TIP END FITTING                | 2.000       | PC  | CE1560A0 | BALCK UNIP AWG18 ST.3135 WIRE | 0.250                            | M     | VE2000A0 | 50/60HZ 230V 30A 4P CONTACTOR | 1.000                          | PC    | VI1220A1 | 4,2x12 TCB SELF-TAPPIN G SCREW | 2.000                         | PC    | VM1075A1 | PLASTIC CLIP TO FIX CONTACTORS | 4.000                          | PC    | VM2191A1 | VE1095 CONTACTOR BRACKET | 1.000                          | PC    |    |          |                          |       |    |
| Code  | Description                      | Qty   | UOM        |                                    |   |                                |             |     |          |                               |                                  |       |          |                               |                                |       |          |                                |                               |       |          |                                |                                |       |          |                          |                                |       |    |          |                          |       |    |
| CE1455A0  | TIP END FITTING                  | 2.000   | PC         |                                    |   |                                |             |     |          |                               |                                  |       |          |                               |                                |       |          |                                |                               |       |          |                                |                                |       |          |                          |                                |       |    |          |                          |       |    |
| CE1560A0  | BALCK UNIP AWG18 ST.3135 WIRE    | 0.250   | M          |                                    |   |                                |             |     |          |                               |                                  |       |          |                               |                                |       |          |                                |                               |       |          |                                |                                |       |          |                          |                                |       |    |          |                          |       |    |
| VE2000A0  | 50/60HZ 230V 30A 4P CONTACTOR    | 1.000   | PC         |                                    |   |                                |             |     |          |                               |                                  |       |          |                               |                                |       |          |                                |                               |       |          |                                |                                |       |          |                          |                                |       |    |          |                          |       |    |
| VI1220A1  | 4,2x12 TCB SELF-TAPPIN G SCREW   | 2.000   | PC         |                                    |   |                                |             |     |          |                               |                                  |       |          |                               |                                |       |          |                                |                               |       |          |                                |                                |       |          |                          |                                |       |    |          |                          |       |    |
| VM1075A1  | PLASTIC CLIP TO FIX CONTACTORS   | 4.000   | PC         |                                    |   |                                |             |     |          |                               |                                  |       |          |                               |                                |       |          |                                |                               |       |          |                                |                                |       |          |                          |                                |       |    |          |                          |       |    |
| VM2191A1  | VE1095 CONTACTOR BRACKET         | 1.000   | PC         |                                    |   |                                |             |     |          |                               |                                  |       |          |                               |                                |       |          |                                |                               |       |          |                                |                                |       |          |                          |                                |       |    |          |                          |       |    |
| VM2191A   | VE1095 CONTACTOR BRACKET         |  | VM2191A1   | VE1095 CONTACTOR BRACKET           |   |                                |             |     |          |                               |                                  |       |          |                               |                                |       |          |                                |                               |       |          |                                |                                |       |          |                          |                                |       |    |          |                          |       |    |



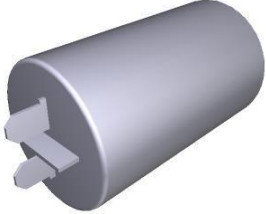
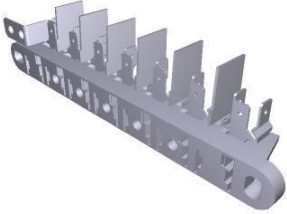

| COMPONENT |  |   | SPARE PART |  |   |      |             |     |     |          |  |       |    |          |                                       |       |    |          |  |       |    |          |   |       |    |          |                                      |       |    |
|-----------|--|---|------------|--|---|------|-------------|-----|-----|----------|--|-------|----|----------|---------------------------------------|-------|----|----------|--|-------|----|----------|---|-------|----|----------|--------------------------------------|-------|----|
| Code      | Description                                  | Image   | Code       | Description                                    | Kit components  |      |             |     |     |          |  |       |    |          |                                       |       |    |          |  |       |    |          |   |       |    |          |                                      |       |    |
| CE1460A   | 5X4MMQ H07RN-F<br>L=1,8MT CABLE              |    | CE1460A1   | 5X4MMQ H07RN-F<br>L=1,8MT CABLE                |   |      |             |     |     |          |  |       |    |          |                                       |       |    |          |  |       |    |          |   |       |    |          |                                      |       |    |
| CN1003A   | 6,3 Uf MOTOR<br>CAPACITOR                    |    | KCN1003A   | 6,3 uF MOTOR<br>CAPACITOR KIT                  | <table border="1"> <thead> <tr> <th>Code</th> <th>Description</th> <th>Qty</th> <th>UOM</th> </tr> </thead> <tbody> <tr> <td>CN1003A0</td> <td>6,3 Uf MOTOR<br/>CAPACITOR</td> <td>1.000</td> <td>PC</td> </tr> <tr> <td>VI1931A0</td> <td>M8x1.65 H4<br/>CH13 ZINC<br/>PLATED NUT</td> <td>1.000</td> <td>PC</td> </tr> <tr> <td>VI1932A0</td> <td>D8 INDENTED<br/>ZINC PLATED<br/>WASHER</td> <td>1.000</td> <td>PC</td> </tr> </tbody> </table>  | Code | Description | Qty | UOM | CN1003A0 | 6,3 Uf MOTOR<br>CAPACITOR                  | 1.000 | PC | VI1931A0 | M8x1.65 H4<br>CH13 ZINC<br>PLATED NUT | 1.000 | PC | VI1932A0 | D8 INDENTED<br>ZINC PLATED<br>WASHER         | 1.000 | PC |          |   |       |    |          |                                      |       |    |
| Code      | Description                                  | Qty   | UOM        |  |   |      |             |     |     |          |  |       |    |          |                                       |       |    |          |  |       |    |          |   |       |    |          |                                      |       |    |
| CN1003A0  | 6,3 Uf MOTOR<br>CAPACITOR                    | 1.000   | PC         |  |   |      |             |     |     |          |  |       |    |          |                                       |       |    |          |  |       |    |          |   |       |    |          |                                      |       |    |
| VI1931A0  | M8x1.65 H4<br>CH13 ZINC<br>PLATED NUT        | 1.000   | PC         |  |   |      |             |     |     |          |  |       |    |          |                                       |       |    |          |  |       |    |          |   |       |    |          |                                      |       |    |
| VI1932A0  | D8 INDENTED<br>ZINC PLATED<br>WASHER         | 1.000   | PC         |  |   |      |             |     |     |          |  |       |    |          |                                       |       |    |          |  |       |    |          |   |       |    |          |                                      |       |    |
| MR1004A   | 41A 450V 7 POLES<br>TERMINAL                 |  | KMR1004A   | 7FTW 1+2+3/4+5+6<br>TERMINAL BLOCK<br>KIT      | <table border="1"> <thead> <tr> <th>Code</th> <th>Description</th> <th>Qty</th> <th>UOM</th> </tr> </thead> <tbody> <tr> <td>MR1004A1</td> <td>41A 450V 7<br/>POLES<br/>TERMINAL</td> <td>1.000</td> <td>PC</td> </tr> </tbody> </table>  | Code | Description | Qty | UOM | MR1004A1 | 41A 450V 7<br>POLES<br>TERMINAL            | 1.000 | PC |          |                                       |       |    |          |  |       |    |          |   |       |    |          |                                      |       |    |
| Code      | Description                                  | Qty   | UOM        |  |   |      |             |     |     |          |  |       |    |          |                                       |       |    |          |  |       |    |          |   |       |    |          |                                      |       |    |
| MR1004A1  | 41A 450V 7<br>POLES<br>TERMINAL              | 1.000   | PC         |  |   |      |             |     |     |          |  |       |    |          |                                       |       |    |          |  |       |    |          |   |       |    |          |                                      |       |    |
| PE1782A   | 200-240Vac 12Vcc<br>6VA POWER SUPPL          |  | KPE1782A   | LED BAR 200-240Vac<br>12Vcc<br>TRANSFORMER KIT | <table border="1"> <thead> <tr> <th>Code</th> <th>Description</th> <th>Qty</th> <th>UOM</th> </tr> </thead> <tbody> <tr> <td>PE1782A0</td> <td>200-240Vac<br/>12Vcc 6VA<br/>POWER<br/>SUPPLY</td> <td>1.000</td> <td>PC</td> </tr> <tr> <td>VM1745A0</td> <td>CARD<br/>SUPPORT</td> <td>4.000</td> <td>PC</td> </tr> </tbody> </table>  | Code | Description | Qty | UOM | PE1782A0 | 200-240Vac<br>12Vcc 6VA<br>POWER<br>SUPPLY | 1.000 | PC | VM1745A0 | CARD<br>SUPPORT                       | 4.000 | PC |          |  |       |    |          |   |       |    |          |                                      |       |    |
| Code      | Description                                  | Qty   | UOM        |  |   |      |             |     |     |          |  |       |    |          |                                       |       |    |          |  |       |    |          |   |       |    |          |                                      |       |    |
| PE1782A0  | 200-240Vac<br>12Vcc 6VA<br>POWER<br>SUPPLY   | 1.000   | PC         |  |   |      |             |     |     |          |  |       |    |          |                                       |       |    |          |  |       |    |          |   |       |    |          |                                      |       |    |
| VM1745A0  | CARD<br>SUPPORT                              | 4.000   | PC         |  |   |      |             |     |     |          |  |       |    |          |                                       |       |    |          |  |       |    |          |   |       |    |          |                                      |       |    |
| TR1136A   | 318°C -0/+24 1 POLE<br>SAFETY<br>THERMOSTAT  |  | KTR1136A   | 318°C -0/+24<br>SAFETY<br>THERMOSTAT KIT       | <table border="1"> <thead> <tr> <th>Code</th> <th>Description</th> <th>Qty</th> <th>UOM</th> </tr> </thead> <tbody> <tr> <td>0H7030A0</td> <td>THERMOSTAT<br/>BULB INLET<br/>COVER</td> <td>1.000</td> <td>PC</td> </tr> <tr> <td>GN1531A0</td> <td>THERMOSTAT<br/>BULB INLET<br/>SEALING</td> <td>1.000</td> <td>PC</td> </tr> <tr> <td>SL1045A0</td> <td>S57 BLACK<br/>SILICONE -<br/>80ml<br/>CARTRIDGE</td> <td>1.000</td> <td>PC</td> </tr> <tr> <td>TR1136A0</td> <td>318°C -0/+24 1<br/>POLE SAFETY<br/>THERMOSTAT</td> <td>1.000</td> <td>PC</td> </tr> <tr> <td>VI1220A1</td> <td>4,2x12 TCB<br/>SELF-TAPPIN<br/>G SCREW</td> <td>3.000</td> <td>PC</td> </tr> </tbody> </table> | Code | Description | Qty | UOM | 0H7030A0 | THERMOSTAT<br>BULB INLET<br>COVER          | 1.000 | PC | GN1531A0 | THERMOSTAT<br>BULB INLET<br>SEALING   | 1.000 | PC | SL1045A0 | S57 BLACK<br>SILICONE -<br>80ml<br>CARTRIDGE | 1.000 | PC | TR1136A0 | 318°C -0/+24 1<br>POLE SAFETY<br>THERMOSTAT | 1.000 | PC | VI1220A1 | 4,2x12 TCB<br>SELF-TAPPIN<br>G SCREW | 3.000 | PC |
| Code      | Description                                  | Qty   | UOM        |  |   |      |             |     |     |          |  |       |    |          |                                       |       |    |          |  |       |    |          |   |       |    |          |                                      |       |    |
| 0H7030A0  | THERMOSTAT<br>BULB INLET<br>COVER            | 1.000   | PC         |  |   |      |             |     |     |          |  |       |    |          |                                       |       |    |          |  |       |    |          |   |       |    |          |                                      |       |    |
| GN1531A0  | THERMOSTAT<br>BULB INLET<br>SEALING          | 1.000   | PC         |  |   |      |             |     |     |          |  |       |    |          |                                       |       |    |          |  |       |    |          |   |       |    |          |                                      |       |    |
| SL1045A0  | S57 BLACK<br>SILICONE -<br>80ml<br>CARTRIDGE | 1.000   | PC         |  |   |      |             |     |     |          |  |       |    |          |                                       |       |    |          |  |       |    |          |   |       |    |          |                                      |       |    |
| TR1136A0  | 318°C -0/+24 1<br>POLE SAFETY<br>THERMOSTAT  | 1.000   | PC         |  |   |      |             |     |     |          |  |       |    |          |                                       |       |    |          |  |       |    |          |   |       |    |          |                                      |       |    |
| VI1220A1  | 4,2x12 TCB<br>SELF-TAPPIN<br>G SCREW         | 3.000   | PC         |  |   |      |             |     |     |          |  |       |    |          |                                       |       |    |          |  |       |    |          |   |       |    |          |                                      |       |    |



| COMPONENT |  |   | SPARE PART |   |  |      |             |     |     |          |  |        |    |          |                     |       |    |
|-----------|--|---|------------|---|--|------|-------------|-----|-----|----------|--|--------|----|----------|---------------------|-------|----|
| Code      | Description                                      | Image   | Code       | Description                                 | Kit components   |      |             |     |     |          |  |        |    |          |                     |       |    |
| VE1075A   | STRAIN RELIEF PA6<br>UL94V2+ FIXING<br>SCREWS    |    | KVE1075A   | PANEL WIRE CLAMP<br>10PCS KIT               | <table border="1"> <thead> <tr> <th>Code</th> <th>Description</th> <th>Qty</th> <th>UOM</th> </tr> </thead> <tbody> <tr> <td>VE1075A0</td> <td>STRAIN RELIEF PA6<br/>UL94V2+<br/>FIXING<br/>SCREWS</td> <td>10.000</td> <td>PC</td> </tr> </tbody> </table>  | Code | Description | Qty | UOM | VE1075A0 | STRAIN RELIEF PA6<br>UL94V2+<br>FIXING<br>SCREWS | 10.000 | PC |          |                     |       |    |
| Code      | Description                                      | Qty   | UOM        |   |  |      |             |     |     |          |  |        |    |          |                     |       |    |
| VE1075A0  | STRAIN RELIEF PA6<br>UL94V2+<br>FIXING<br>SCREWS | 10.000  | PC         |   |  |      |             |     |     |          |  |        |    |          |                     |       |    |
| VM1310A   | COVER FOR<br>XB/XV/XVC/XG<br>TERMINAL BLOCK      |    | VM1310A0   | COVER FOR<br>XB/XV/XVC/XG<br>TERMINAL BLOCK |  |      |             |     |     |          |  |        |    |          |                     |       |    |
| VM1745A   | CARD SUPPORT                                     |  | KVM1745A   | BOARD SUPPORT<br>10 PCS KIT                 | <table border="1"> <thead> <tr> <th>Code</th> <th>Description</th> <th>Qty</th> <th>UOM</th> </tr> </thead> <tbody> <tr> <td>VM1745A0</td> <td>CARD SUPPORT</td> <td>10.000</td> <td>PC</td> </tr> </tbody> </table>   | Code | Description | Qty | UOM | VM1745A0 | CARD SUPPORT                                     | 10.000 | PC |          |                     |       |    |
| Code      | Description                                      | Qty   | UOM        |   |  |      |             |     |     |          |  |        |    |          |                     |       |    |
| VM1745A0  | CARD SUPPORT                                     | 10.000  | PC         |   |  |      |             |     |     |          |  |        |    |          |                     |       |    |
| VM1750A   | BRASS COMB CLAM                                  |  | KVM1750A   | COMB TERMINAL<br>BLOCK KIT                  | <table border="1"> <thead> <tr> <th>Code</th> <th>Description</th> <th>Qty</th> <th>UOM</th> </tr> </thead> <tbody> <tr> <td>VI1040A0</td> <td>INDENTED<br/>INTERNAL<br/>WASHER D=6<br/>ZN</td> <td>2.000</td> <td>PC</td> </tr> <tr> <td>VM1750A0</td> <td>BRASS COMB<br/>CLAMP</td> <td>1.000</td> <td>PC</td> </tr> </tbody> </table> | Code | Description | Qty | UOM | VI1040A0 | INDENTED<br>INTERNAL<br>WASHER D=6<br>ZN         | 2.000  | PC | VM1750A0 | BRASS COMB<br>CLAMP | 1.000 | PC |
| Code      | Description                                      | Qty   | UOM        |   |  |      |             |     |     |          |  |        |    |          |                     |       |    |
| VI1040A0  | INDENTED<br>INTERNAL<br>WASHER D=6<br>ZN         | 2.000   | PC         |   |  |      |             |     |     |          |  |        |    |          |                     |       |    |
| VM1750A0  | BRASS COMB<br>CLAMP                              | 1.000   | PC         |   |  |      |             |     |     |          |  |        |    |          |                     |       |    |